

Building Hardware

EHF

ENTER



CLICK TO ENLARGE, THEN CLICK ON THE SELECTED PAGE



Table of Contents

DOOR AND WINDOW HARDWARE BRONZE COLLECTIONS.....	3
Louis XV brass	4
Louis XVI brass	5
Period brass	6
Hand-chased bronze	7-8
Brass period cremone bolts.....	9
Brass Art-deco	10
Brass flush pocket door pulls.....	11
Brass period latches.....	12
Oversize brass knobs.....	13
BRASS DOOR AND WINDOW HARDWARE COLLECTIONS.....	15
Rustic brass door and window hardware.....	16
Oversize italian brass pulls and door set	17
Oversize gate and refrigerator brass pulls	18
Brass pulls collection	19
Brass surface bolts and latches	20
Brass door pulls	21
Brass peep hole (speakeasy)	22
Brass door knockers	23
Louis XIV hand-chased bronze door knocker	24
RUSTIC IRON DOOR AND WINDOW HARDWARE COLLECTIONS	25
Blacksmith waxed iron door sets.....	26
Blacksmith waxed iron.....	27
Cast iron collection	28
Euro pewter door and window hardware.....	29
Miscellaneous iron door and window hardware.....	30
Iron cremones, surface bolts and window knob.....	31
Iron door sets.....	32
Euro pewter door sets.....	33
Iron door pulls.....	34
Iron pulls collection	35
Euro pewter door and oversize cabinet pulls	36
Iron and euro pewter door knockers and iron nails.....	37
BUILDING HINGES AND DOOR STOPS.....	39
Full mortise brass building hinges.....	40 et 41
Full mortise iron inset building hinges/caps	42
Full mortise iron building hinges.....	43
Euro pewter strap hinges.....	44
Euro pewter shutter dogs and pintles.....	45
Brass and iron door stops.....	46



*Door and Window Hardware
Bronze Collections*



3



LOUIS XV BRASS



BRASS	A	B	C
1	30.15101.002		4-3/8"
2	30.0441.2	9"	1-3/4"
3	32.0464.2	3"	1-1/2"
4	30.15101.002		4-3/8"
5	30.0450.2	11-1/2"	2"
6	09.0446.2	3"	1"
7	32.0444.2	3"	1-1/4"
8	30.0413.0002	12"	1-7/8"
9	30.0410.2	12"	1-5/8"
10	18.3595.302	12"	1-5/8"
11	30.3510.0002	3-1/4"	3-1/4"
12	30.0423.0002		4"
13	30.0420.2	11-1/2"	1-7/8"

BRASS	A	B	C
14	06.444.2	1-3/4"	5/8"
15	30.A414.0002	*	6"
16	30.0413.0002		1-3/4"
17	30.B414.0002	3-1/8"	4-1/2"
18	18.0414.9002**	95"	1-5/8"
19	30.0423.0002		4"
20	30.0421.2	9-1/2"	1-5/8"
21	06.425.2	1-3/8"	15/16"
22	30.A424.0002	3"	1-1/4"
23	30.0413.2	1-3/4"	1-3/4"
24	30.C426.2	1-3/4"	4-1/2"
25	32.0464.2	3"	1-3/4"

* 1.0 and 1.5 meter rods available (approx. 39-1/2" and 59-1/4"). Specify steel or brass.
 ** Locking cressone cannot be keyed.

LOUIS XVI BRASS

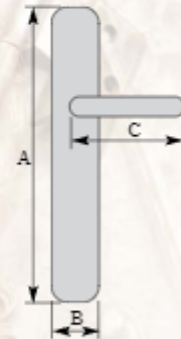
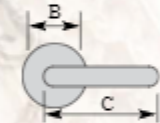
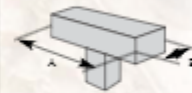
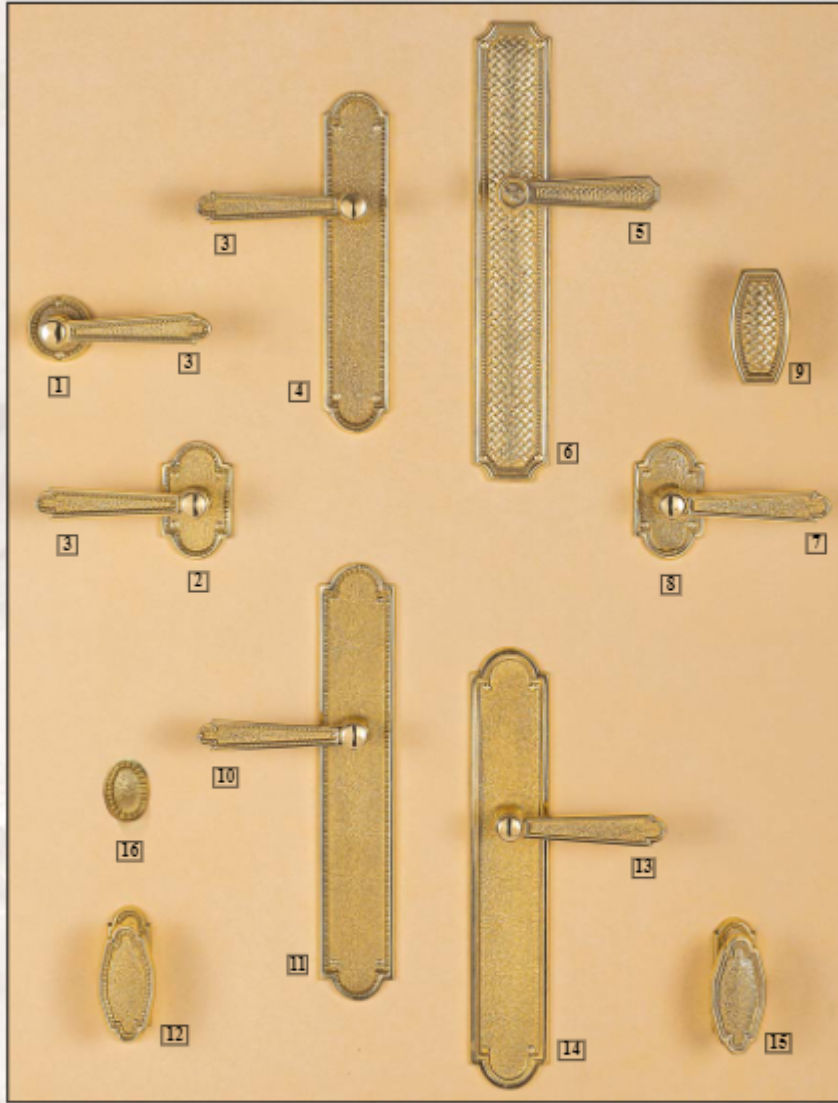

BRASS	A	B	C
1	30.B526.2	1-5/8"	
2	30.0546.2	3"	1-3/4"
3	30.0523.2		4-3/8"
4	30.0521.2	8-1/2"	1-5/8"
5	31.0573.2		4-1/8"
6	30.0570.2	11-1/2"	2"
7	30.0513.2		4-1/4"
8	30.0536.2	3"	1-3/4"

BRASS	A	B	C
9	32.0574.2	2-7/8"	1-5/8"
10	30.0523.2		4-3/8"
11	30.0520.2	11"	1-7/8"
12	32.0524.2	3-1/8"	1-1/2"
13	30.0513.2		4-1/4"
14	30.0530.2	11"	2"
15	32.0514.2	3"	1-1/2"
16	30.3570.0002	1-3/16"	7/8"



PERIOD BRASS

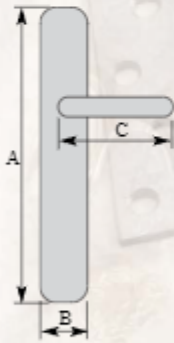
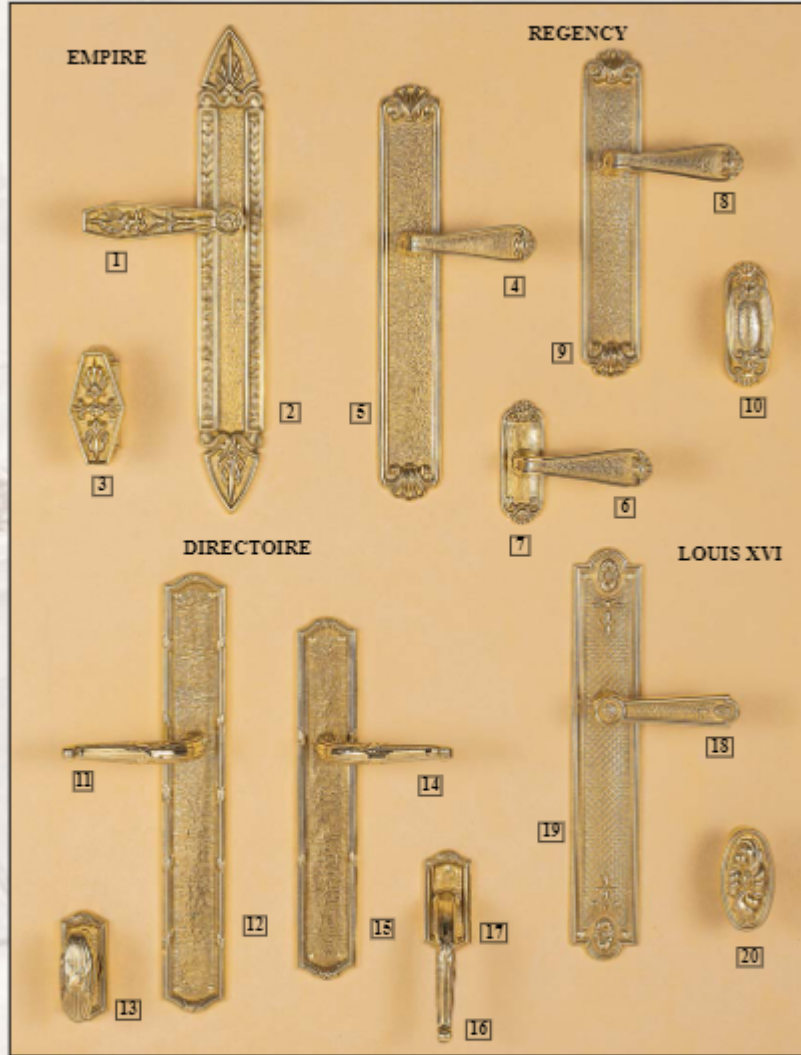

BRASS	A	B	C	BRASS	A	B	C
1	31.0713.2		4-3/8"	11	30.0613.0002		4"
2	30.0710.2	13-1/4"	1-7/8"	12	30.0610.0002	12"	1-3/4"
3	32.0714.2	3"	1-6/8"	13	30.A614.0002	3-1/8"	1-1/4"
4	31.0313.2		3-7/8"	14	30.0613.0002		4"
5	30.0310.2	11-3/8"	1-3/4"	15	30.0611.2	10-1/4"	1-3/4"
6	31.0313.2		3-7/8"	16	30.0613.0002		4"
7	30.B316.0002	3-1/2"	1-1/4"	17	30.B616.0002	3"	1-1/4"
8	31.0313.2		3-7/8"	18	31.0213.2		4"
9	30.0311.2	9"	1-11/16"	19	30.0210.2	11-1/2"	2"
10	32.0314.2	3-1/4"	1-5/16"	20	32.0214.2	3"	1-1/2"

HAND-CHASED BRONZE

Samples are gold plated

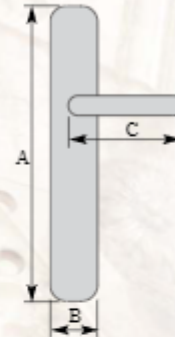
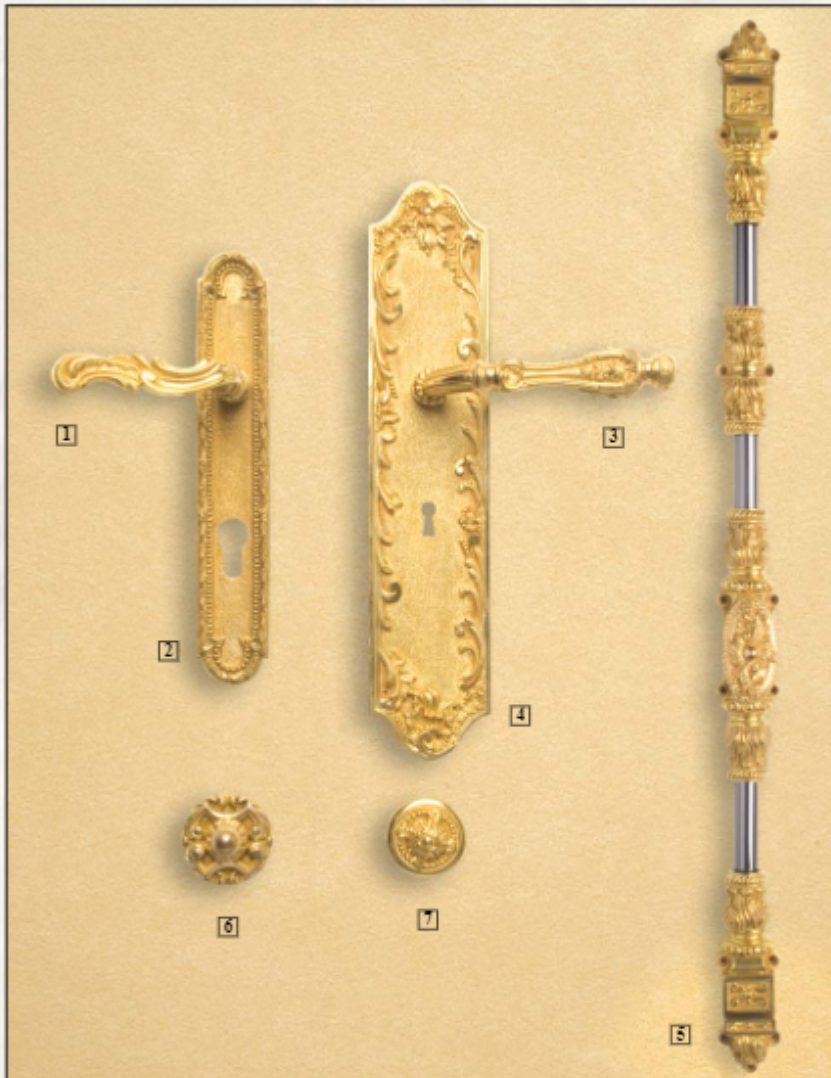

NOTE: Locking cransons cannot be keyed.

BRONZE	A	B	C
1	31.156.2		4-1/4"
2	30.126.2	9-7/8"	1-11/16"
3	31.157.2		5-7/8"
4	30.295.2	13"	2-3/4"
5	18.089.2*	8"	custom
6	32.121.2	2"	diameter
7	32.221.2	1-3/4"	diameter

* 1 meter rods (approx. 39-1/2" each) available and 1.5 meter rods (approx. 59-1/4" each) available. Specify steel or brass.

HAND-CHASED BRONZE



Samples are gold plated

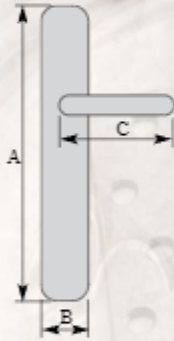
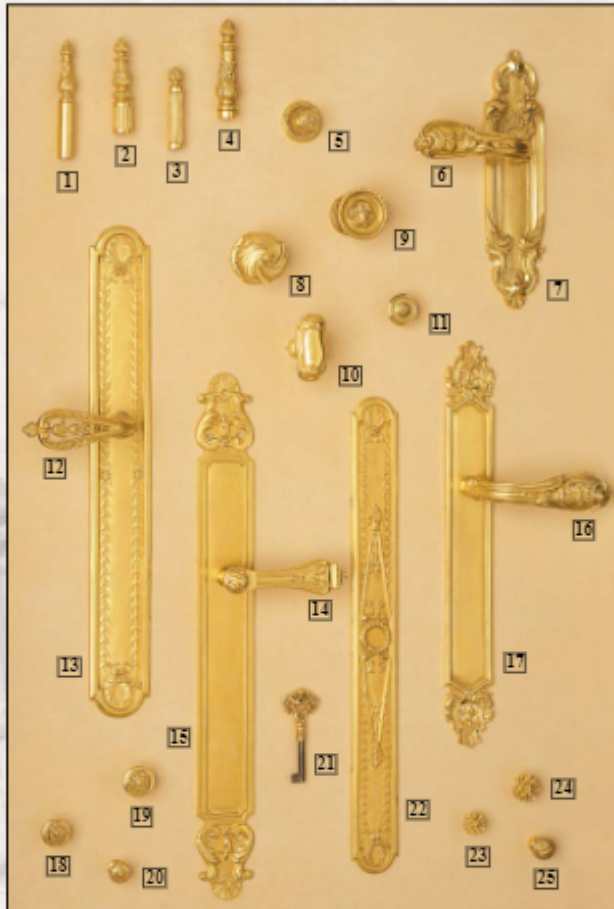

BRONZE		A	B	C
1	BF304	4-1/2"	5/8"	
2	BF106	3-1/2"	3/4"	
3	BF327	3"	5/8"	
4	BF308	3-1/2"	7/8"	
5	BF999	1-1/2"	1-1/2"	
6	BF204			4-1/2"
7	BF374	9-3/4"	2-1/2"	
8	BF1436	2"	2"	
9	BF998	2"	2"	
10	BF228	2-3/8"	1-3/8"	
11	06.3638.302	15/16"	1-1/4"	
12	BF195			4-1/2"
13	G2733	17-1/2"	2-1/4"	

BRONZE		A	B	C
14	BF279			4-3/4"
15	BF165	20"	2-1/8"	
16	BF211			5-1/4"
17	BF163	16"	2"	
18	G229	1-3/16"	1-3/16"	
19	G228	1-3/8"	1-3/8"	
20	G335	7/8"	7/8"	
21	BF31	2"	1-1/2"	
22	G1786	18-1/2"	1-7/8"	
23	06.0585.0232	7/8"	7/8"	
24	06.0585.0292	1-3/16"	1-3/16"	
25	Z579	1"	1"	

BRASS PERIOD CREMONE BOLTS



NOTE: Locking cremone cannot be keyed.

BRONZE	A	B	C
1 18.0314.2	6"	6"	1-3/4"
2 18.0524.2	6"	6"	1-3/4"
3 18.0614.2	6"	6"	1-3/4"
4 18.0424.2	6"	6"	1-3/4"
5 18.0214.2	6"	6"	1-3/4"

1 meter rods (approx. 39-1/2" each) available
and 1.5 meter rods (approx. 59-1/4" each) available.
Specify steel or brass.



BRASS ART DECO

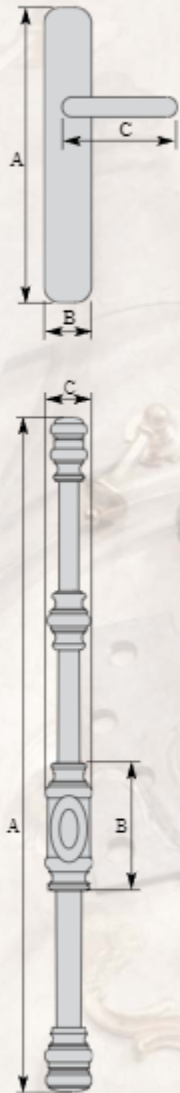

NOTE: Plates and levers sold together. Locking cremone cannot be keyed.

*1 meter rods (approx. 39-1/2" each)
and 1.5 meter rods (approx. 59-1/4" each) available.

BRASS	A	B	C
1 33.4000.2	9-7/8"	1-3/4"	4-1/2"
2 06.3000.2	7/8"	3/4"	
3 33.3000.2	9-5/8"	1-3/4"	4-1/2"
4 06.4000.2	1-3/8"	7/8"	
5 33.4010.2	2"	1-5/8"	4-1/2"

BRASS	A	B	C
6 33.4010.2	2"	1-5/8"	
7 33.3010.2	2-3/8"	1-5/8"	4-1/2"
8 33.3000.2	2-3/8"	1-5/8"	
9 18.4010.2	*	6"	1-5/8"
10 18.3000.2	*	6"	2"

BRASS FLUSH POCKET DOOR PULLS

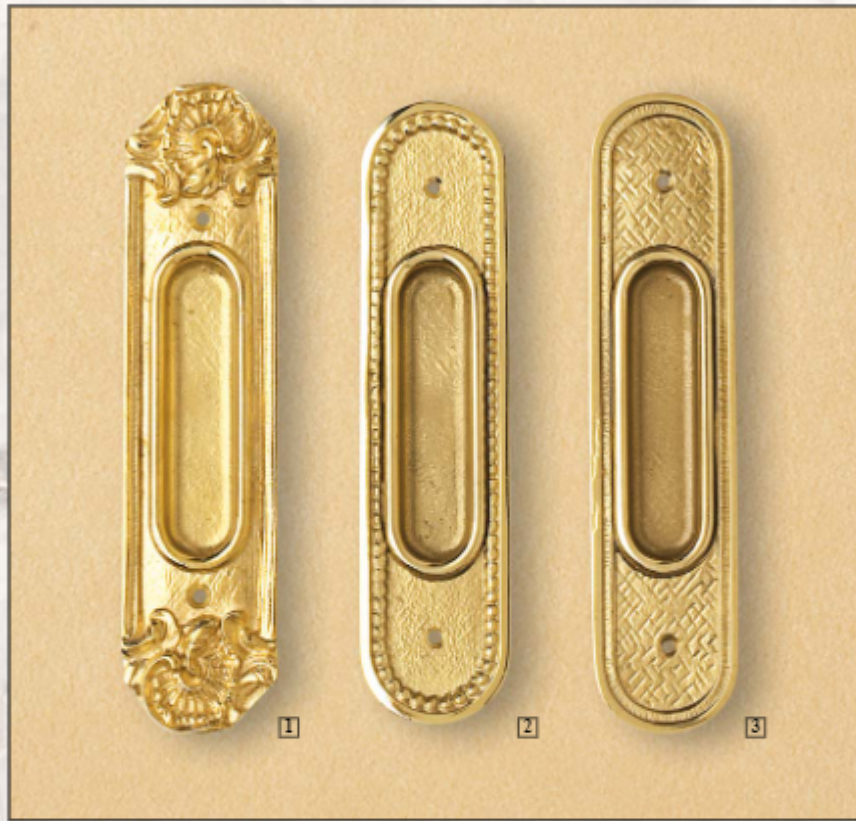

BRONZE		A	B
1	05.1647.2	1-3/8"	6"
2	05.1649.2	1-3/8"	5-3/4"
3	05.1648.2	1-3/8"	5-7/8"



BRASS PERIOD LATCHES

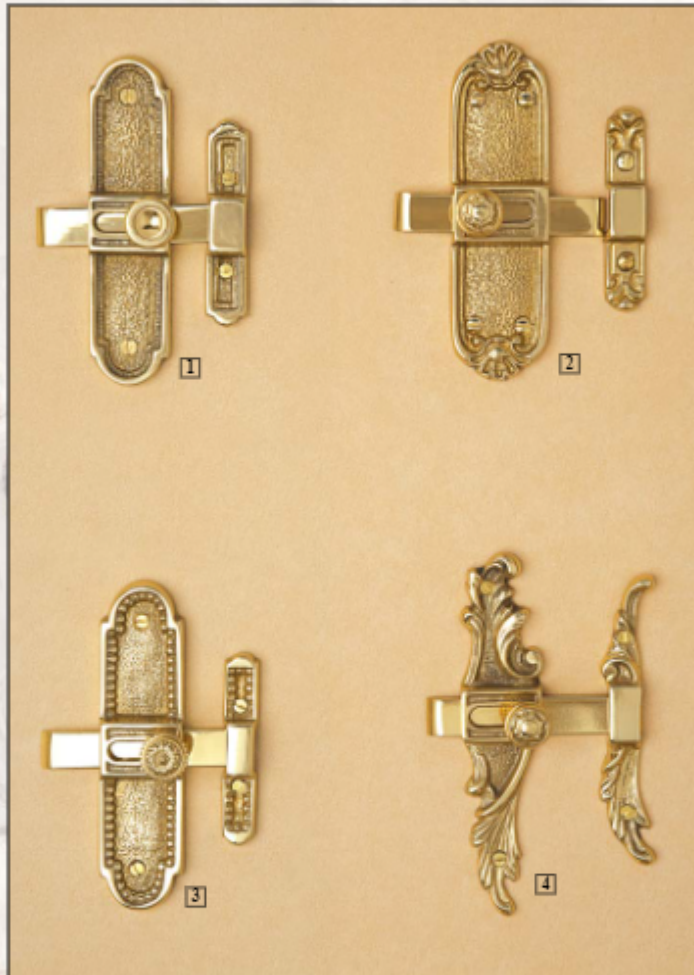

BRONZE		A	B	C	D
1	20.0517.2	4"	1"	2-1/2"	1/2"
2	20.0317.2	4"	1-1/4"	2-1/2"	1/2"
3	20.0527.2	4"	1"	2-1/2"	1/2"
4	20.0427.2	4-1/2"	1"	3-1/2"	1/2"

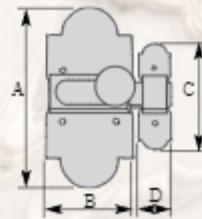

OVERSIZE BRASS KNOBS



BRASS		A	B	C
1	30.0168.0702	2-1/2"	3-3/8"	3-1/4"
2	30.3037.0702	2-5/8"	3"	3-1/8"
3	32.0135.2	2-1/4"	1-5/8"	1-1/8"
4	30.3638.0602	2-3/8"	1-3/4"	2-3/4"
5	30.3638.0802	3-1/8"	2-3/4"	3-1/2"
6	30.3511.2	3"	2-7/8"	3-1/4"
7	30.3510.2	3-3/8"	2-7/8"	3-3/8"

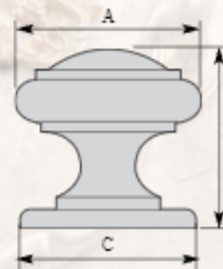



Versailles showroom

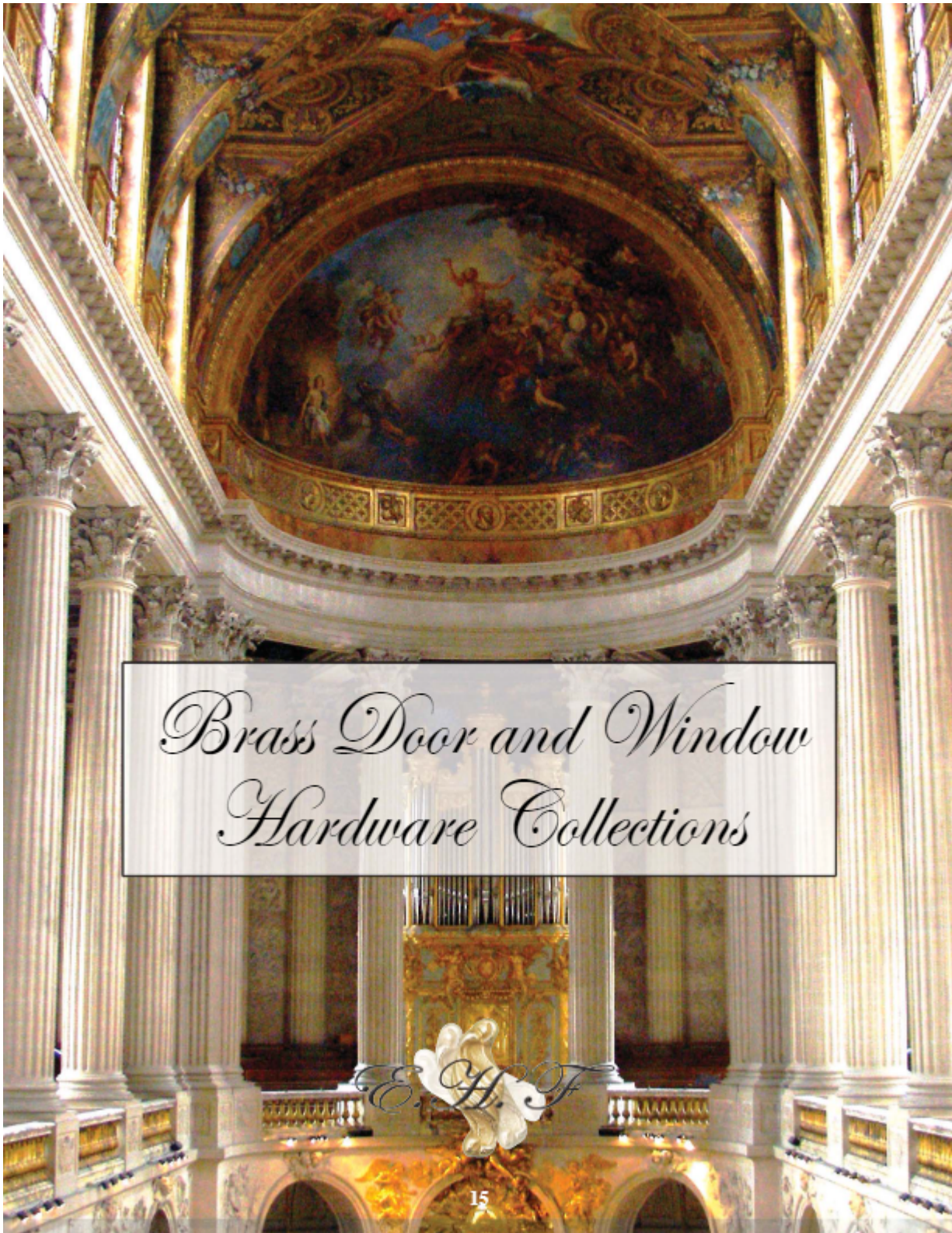

*Brass Door and Window
Hardware Collections*

E. H. F.

E.H.F. RUSTIC BRASS DOOR AND WINDOW HARDWARE

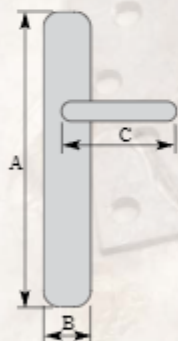
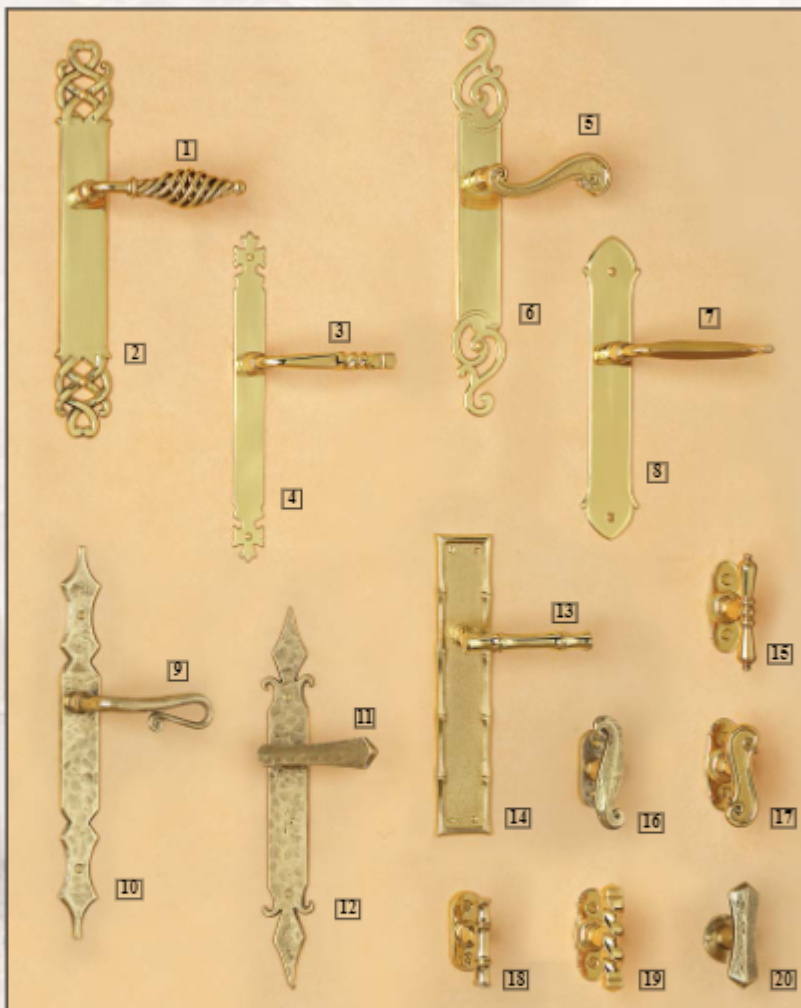

BRASS	A	B	C
1 31.1025.2			5"
2 30.1043.2	12"	1-7/8"	
3 31.1020.2			4-3/4"
4 30.1042.2	10"	1"	
5 31.1023.2			4-1/8"
6 30.1044.2	12"	1-3/4"	
7 31.1021.2			4-3/4"
8 30.1050.2	9-7/16"	2"	
9 30.0123.2			4-1/4"
10 30.0110.2	12-3/4"	1-3/8"	

BRASS	A	B	C
11 30.0113.2			3-7/8"
12 30.0120.2	12-3/4"	1-3/4"	
13 30.3503.2			4-1/8"
14 30.3648.2	9-5/8"	1-7/8"	
15 32.1073.2	3-1/2"	1-1/4"	
16 30.A124.2	3-5/8"	1-1/8"	
17 32.1076.2	3-1/8"	1-1/4"	
18 30.3554.2	2-3/4"	1-1/16"	
19 32.1072.2	3-1/4"	1-1/4"	
20 30.A114.2	3-3/8"	1-5/8"	

OVERSIZE ITALIAN BRASS PULLS AND DOOR SET

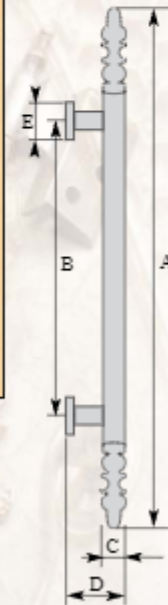

BRASS	A	B	C	D	E
1 19.0706.0282	11"	8-1/4"	1-5/8"	3-1/2"	2-1/8"
2 19.0423.0282*	14-3/8"	11"	1-7/8"	3-3/4"	
3 19.0423.2	17"	11"	3-1/4"		
4 30.722.2	17"		3-1/4"	3"	

* See page 97 of the furniture catalog for other sizes.

OVERSIZE GATE AND REFRIGERATOR BRASS PULLS

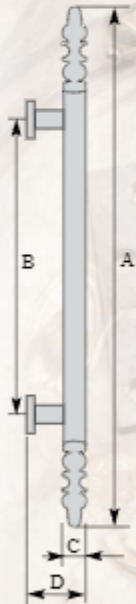

NOTE: For an added touch see rosettes pages 81 and 82 on furniture hardware catalog

BRASS	A	B	C	D	BRASS	A	B	C	D		
1	19.1378.502	19-1/2"	15-1/8"	7/8"	2-1/2"	7	19.0009.0502	20"	11-1/8"	11/16"	2-1/4"
2	05.1384.302	12-7/8"	11-7/8"	1/2"	3"	8	19.0009.0402	16"	7-3/16"	11/16"	2-1/4"
3	05.1384.202	8-7/8"	7-7/8"	1/2"	2-3/4"	9	19.0009.0302	12"	5-9/16"	11/16"	2-1/4"
4	19.0005.0202	8-1/2"	4"	1/2"	1-5/8"	WITH ROSETTES	19.0009.1002	39-3/8"	29-3/4"	11/16"	2-1/4"
5	19.0005.0302	11-3/4"	6-1/2"	1/2"	1-5/8"	WITH ROSETTES	19.0005.0602	19-1/4"	13-3/4"	1/2"	1-5/8"
6	19.0005.0452	18-1/8"	12"	1/2"	1-5/8"						

BRASS PULLS COLLECTION



BRASS		A	B	C	D
1	05.68.102	4-3/8"	3-3/4"	5/8"	1-5/8"
2	05.68.122	5-1/2"	5"	5/8"	1-5/8"
3	05.68.162	6-3/4"	6-5/16"	5/8"	1-5/8"
4	19.68.202	8-3/4"	8"	7/8"	2-3/8"
5	19.68.302	12-3/4"	12"	7/8"	2-3/8"
6	19.68.402	16-3/4"	16"	7/8"	2-3/8"



BRASS SURFACE BOLTS AND LATCHES



NOTE: Item # 2 can be special ordered with steel rod.

BRASS	A	B	C	BRASS	A	B	C	D
1	18.3595.202	8"	1-1/2"	3	20.220.802	1-3/4"	4"	
1	18.3595.302	12"	1-1/2"	4	20.695.2	4"	1-5/8"	2-5/8" 3/4"
1	18.3595.402	15-3/4"	1-1/2"	5	20.5302.2	3-1/4"	1-1/2"	3" 1"
1	18.3595.602	24"	1-1/2"	6	20.40	2-3/4"	1-9/16"	1-13/16" 9/16"
2	18.162	8"	2-1/4"	7	11.M13B.0002	2"	2"	
2	18.0163.0302	12"	2-1/4"	8	11.M13A.0002	3/4"	2"	
2	18.0163.0502	18"	2-1/4"	9	11.OCDU.2	1"	1-1/4"	
2	18.0163.0602	24"	2-1/4"	10	11.BR10.0002	1-1/8"	2-1/4"	
2	18.0163.0802	31-1/2"	2-1/4"					

BRASS DOOR PULLS



NOTE: Pulls # 1 and # 2 can be special ordered up to 1 meter long (approx. 39-1/2").
All pulls on this page sold in pairs only.

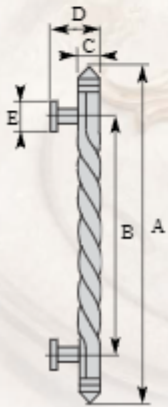

BRASS		A	B	C	D	E
1	19.0708.0252	11-1/4"	10"	1-3/16"	3"	2-1/8"
2	19.0709.0252	11-1/4"	10"	1-3/16"	3"	2-1/8"
3	19.0705.402	16-3/4"	13-7/8"	1-5/8"	3-1/2"	2-1/8"
4	19.0711.302	14-3/4"	11-7/8"	1-1/2"	3-1/2"	3"
5	19.0728.2	11-1/4"	9-1/4"	1"	2-1/2"	2-1/8"



BRASS PEEP HOLE (SPEAKEASY)

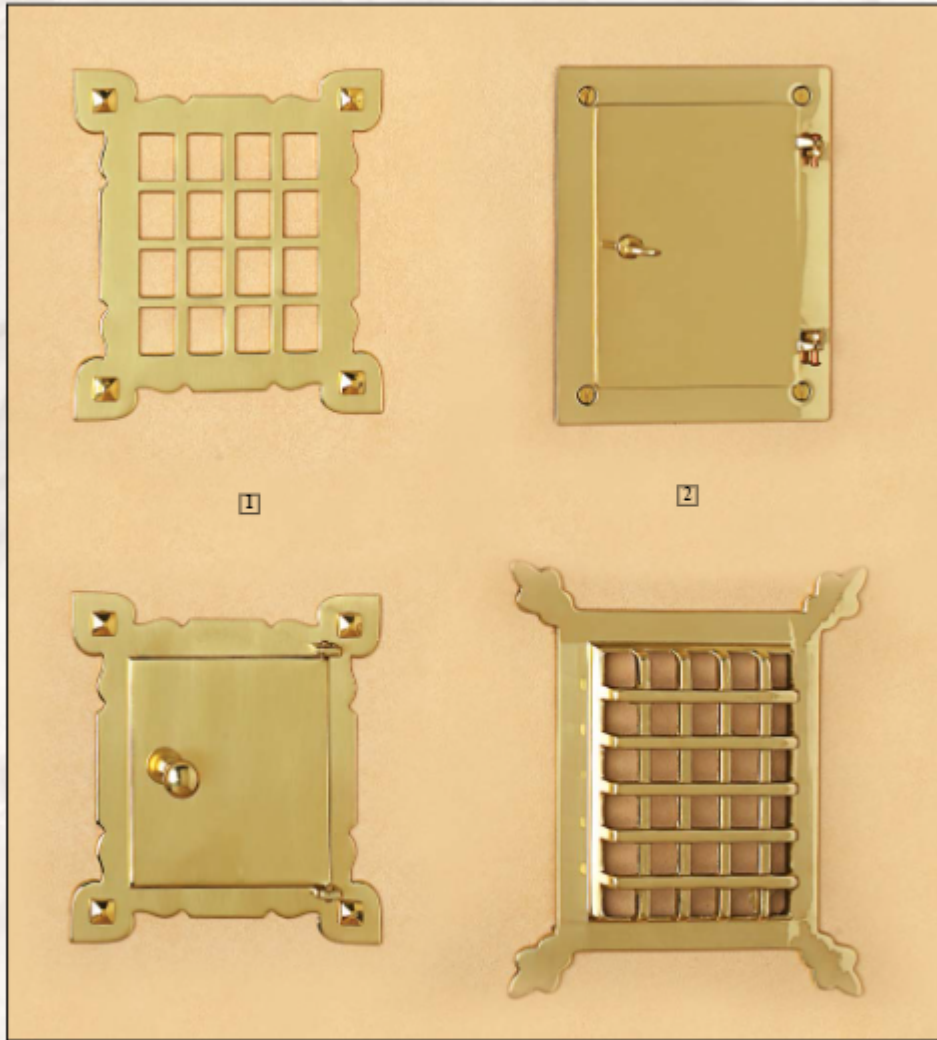

BRASS		A	B
1	21.1286.2	5-3/4"	5"
2	21.5269.1252	7-1/2"	6-1/4"

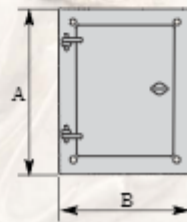

BRASS DOOR KNOCKERS



BRASS	A	B	C
1 17.701.102	4"	4"	2-1/4"
2 17.701.122	5"	5"	2-7/8"
3 17.701.152	6"	6"	3-3/8"
4 17.698.102	4"	4"	2-1/4"
5 17.698.122	5"	5"	2-7/8"
6 17.698.152	6"	6"	3-3/8"

BRASS	A	B	C
7 17.700.102	4"	4"	2-1/4"
8 17.700.122	5"	5"	2-7/8"
9 17.0645.2	7-9/16"	4-3/8"	
10 17.0645.152	10-3/8"	6"	
11 17.704.2	9-1/2"	5-1/4"	
1107 17.700.152	6"	6"	3-3/8"

LOUIS XIV HAND-CHASED BRONZE DOOR KNOCKER

E.H.F.



BRASS
I 17.12.2

A	B	C
14"	9"	3"

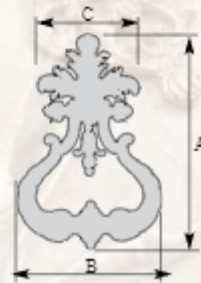

24



*Rustic Iron Door and Window
Hardware Collections*



BLACKSMITH WAXED IRON DOOR SETS

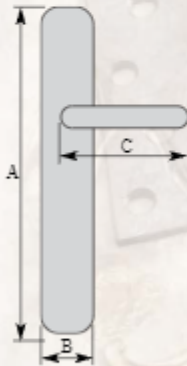

NOTE: The hardware on this page is sold with the finish shown.

IRON		A	B	C
1	17.980501.03	8"	7"	
2	30.9809.3			5-3/8"
3	30.5165.3	5-3/8"	1-1/2"	
4	30.9808.3			4-1/4"
5	30.4660.3	10-7/8"	1-3/16"	
6	18.980301.03	15-5/8"	2"	
7	30.9809.3			5-3/8"

IRON		A	B	C
8	30.98070.3	13-3/4"	2"	
9	30.1524.3			4-1/2"
10	30.9800.3	11-3/8"	2"	
11	30.9806.3	5-3/4"	4-1/2"	
12	30.9809.3			5-3/8"
13	30.3997.3			6"
14	30.3100.3	2-3/4"	1-3/16"	

BLACKSMITH WAXED IRON

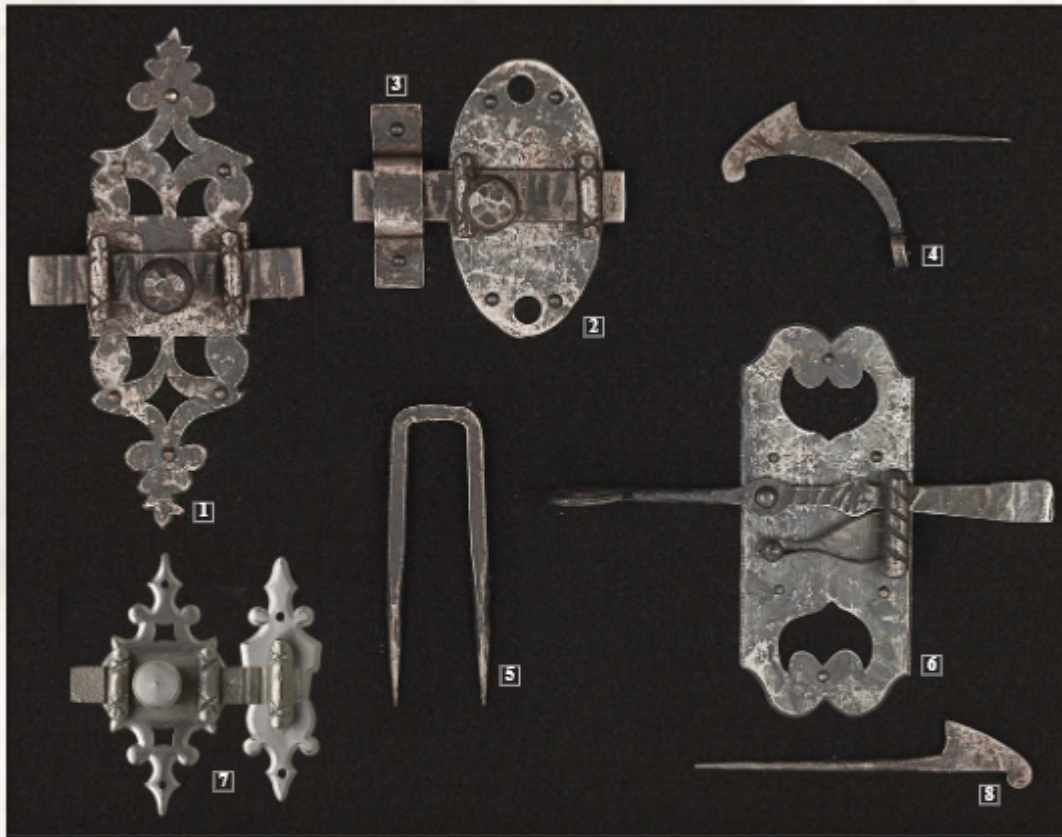

NOTE: Item # 7 shown in iron. All other items sold in finish shown.

IRON		A	B	C	D
1	20.0002.0003	6-1/4"	2-1/8"		
2	20.0004.0873	3-3/8"	1-7/8"		
3	11.608.3	2-3/8"	5/8"		
4	11.607.3	3-3/4"	2"		
5	11.601.3	3-3/4"	1-1/8"		
6	20.0203.0123	5"	2-1/8"		
7	20.5302.1	3-1/4"	1-1/2"	3"	1"
8	11.600.3	4"	1"		

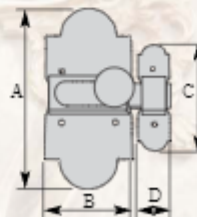



CAST IRON COLLECTION



IRON		A	B	C	D
1	19.634.1	9"	7-7/8"	1-1/4"	2-3/4"
2	05.634.1	5-3/4"	5"	3/4"	2-1/4"
3	06.69.1	1-1/4"	1-3/4"		
4	05.632.1	1-3/4"	4-1/4"		
5	06.72.1	1-1/2"			
6	06.71.1	1-1/2"			
7	05.630.1	1-3/4"	4-1/4"		
8	06.70.1	1-7/16"	1-3/4"		
9	05.633.1	6-5/8"	3-3/4"	1"	2-1/8"
10	19.633.1	13-1/2"	8"	1-3/4"	3-1/2"

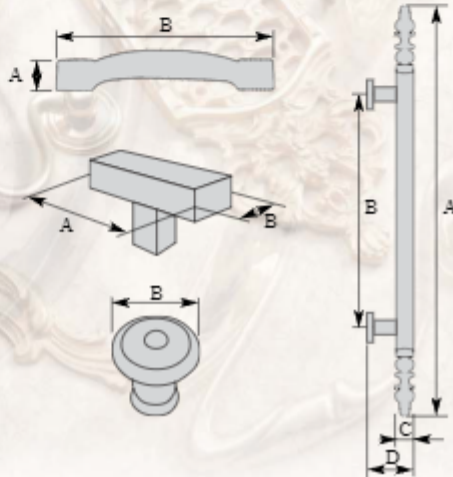

EURO PEWTER DOOR AND WINDOW HARDWARE

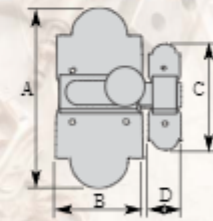
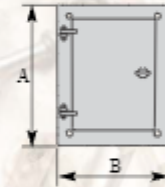
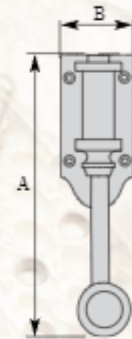
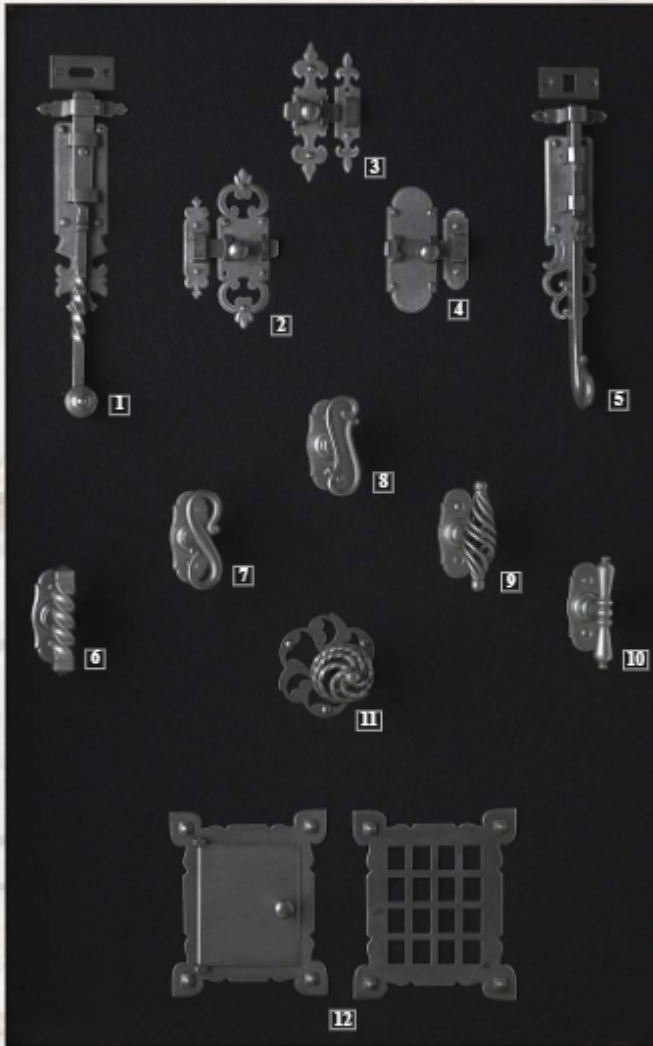

NOTE: Sold in euro pewter which is a galvanized steel and is suitable for outdoor.

IRON		A	B	C	D
1	18.1308.253	12"	1-1/2"		
1	18.1308.403	16"	1-1/2"		
2	20.682.3	4-7/8"	1-1/2"	3-1/8"	3/4"
3	20.680.3	4-3/8"	1-3/16"	3-3/4"	3/4"
4	20.695.3	4"	1-1/2"	2-9/16"	3/4"
5	18.1309.253	12"	1-3/4"		
5	18.1309.403	16"	1-3/4"		

IRON		A	B
6	32.1072.3	3-1/4"	1-1/4"
7	32.1070.3	3"	1-1/4"
8	32.1076.3	3"	1-1/4"
9	32.1079.3	3-3/8"	1-1/4"
10	32.1073.3	3-1/2"	1-1/4"
11	32.1052.3	3-1/4"	3-1/4"
12	21.1286.3	5-3/4"	5"

MISCELLANEOUS IRON DOOR AND WINDOW HARDWARE

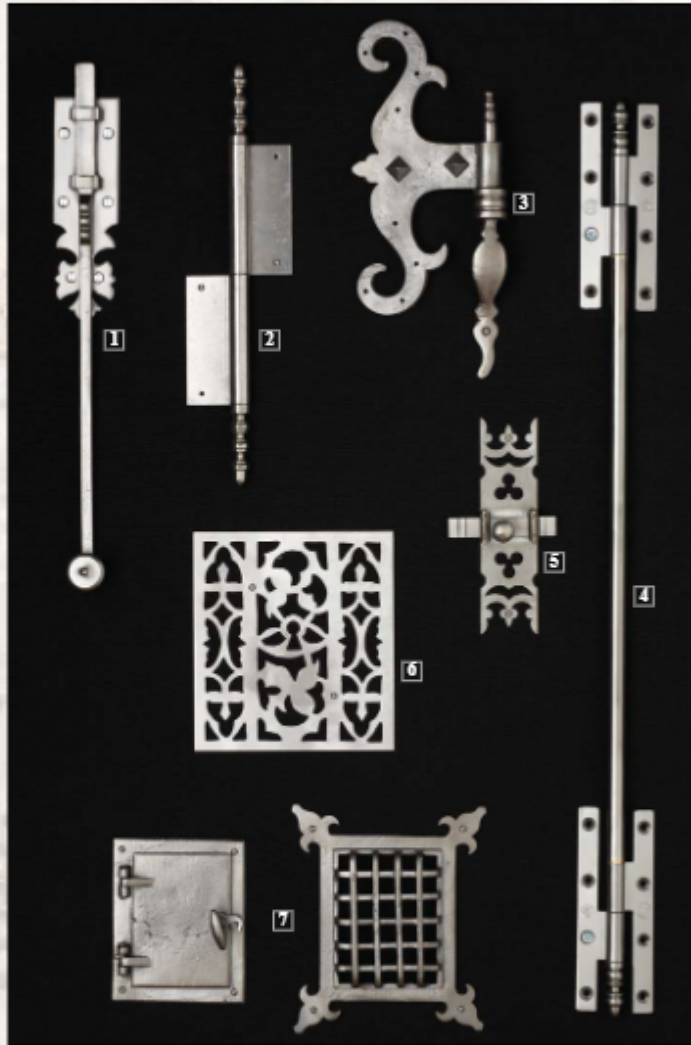
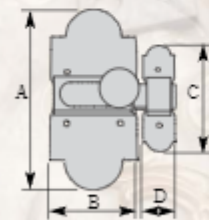
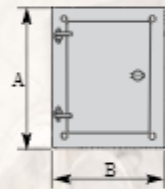
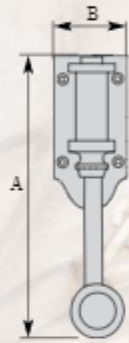

IRON		A	B
1	18.1307.251	9-1/4"	2"
1	18.1307.301	11-3/4"	2"
1	18.1307.451	15-3/4"	2"
2	01.11.321	13"	3-1/4"
3	01.5500.1	11"	5"

IRON		A	B
4	02.0106.1	2-3/8"	
5	20.1531.1	6-3/4"	1-3/4"
6	09.9814.1	6-3/4"	6"
7	21.5269.171	7"	6"

IRON CREMONES, SURFACE BOLTS AND WINDOW KNOB

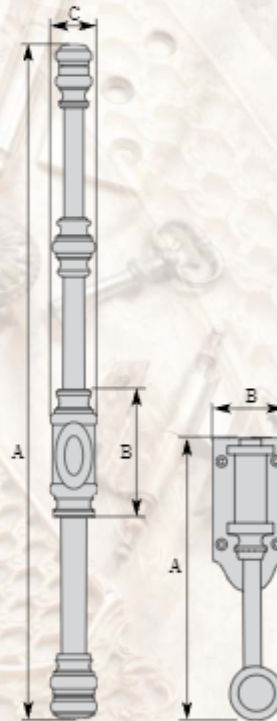

IRON		A	B	C
1	18.60.301	12"	1-5/8"	
1	18.60.451	18"	1-5/8"	
2	* 18.59	see note	4-7/8"	1-1/2"
3	** 18.59L	see note	5-3/4"	1-5/8"
4	18.0059.BC01			1-5/8"
5	11.M13A.1	3/4"	2"	
6	11.1000.C141	2"	2"	
7	18.0059.DUM1	3-1/2"	1-1/4"	

NOTE: Item # 1 is stocked in euro pewter, a galvanized exterior finish. Items # 3 and # 4 can be special ordered in euro pewter. Iron locking cremones can also be keyed.

* 1 meter rods (approx. 39-1/2" each.) available.
 ** 1.5 meter rods (approx. 59-1/4" each.) available.



IRON DOOR SETS

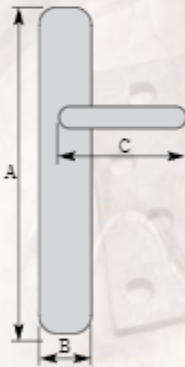
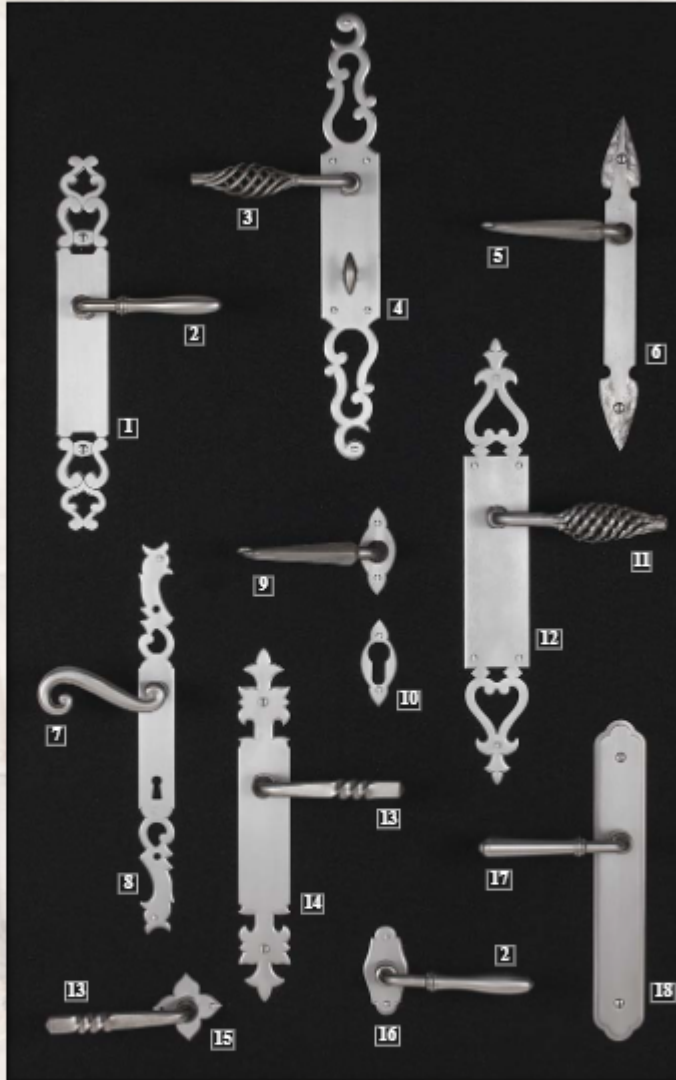

IRON		A	B	C
1	30.4450.1	11-1/2"	1-1/2"	
2	30.3500.0001			4-3/4"
3	30.1392.0001			5-1/2"
4	30.5167.1	13-1/2"	1-3/4"	
5	30.9808.0001			4-1/2"
6	30.4660.1	10-7/8"	1-3/16"	
7	30.5252.0001			3-1/2"
8	30.0950.1	12-1/4"	1-3/16"	
9	30.3100.1	2-3/4"	1-3/16"	4-1/2"

IRON		A	B	C
10	30.3100.CYL1	2-3/4"	1-3/16"	
11	30.1991.0001			5-1/2"
12	30.005A.1	13-3/4"	2"	
13	30.1524.0001			4-1/2"
14	30.1538.1	11-1/4"	1-1/2"	
15	30.5138.1	1-1/2"	1-1/2"	4-1/2"
16	30.1303.1	2-7/8"	1-3/8"	4-3/4"
17	30.3200.0001			4-3/4"
18	30.4460.1	10-1/8"	1-1/2"	

EURO PEWTER DOOR SETS

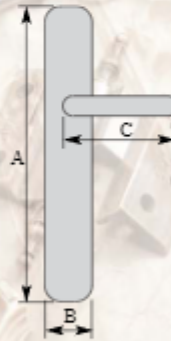
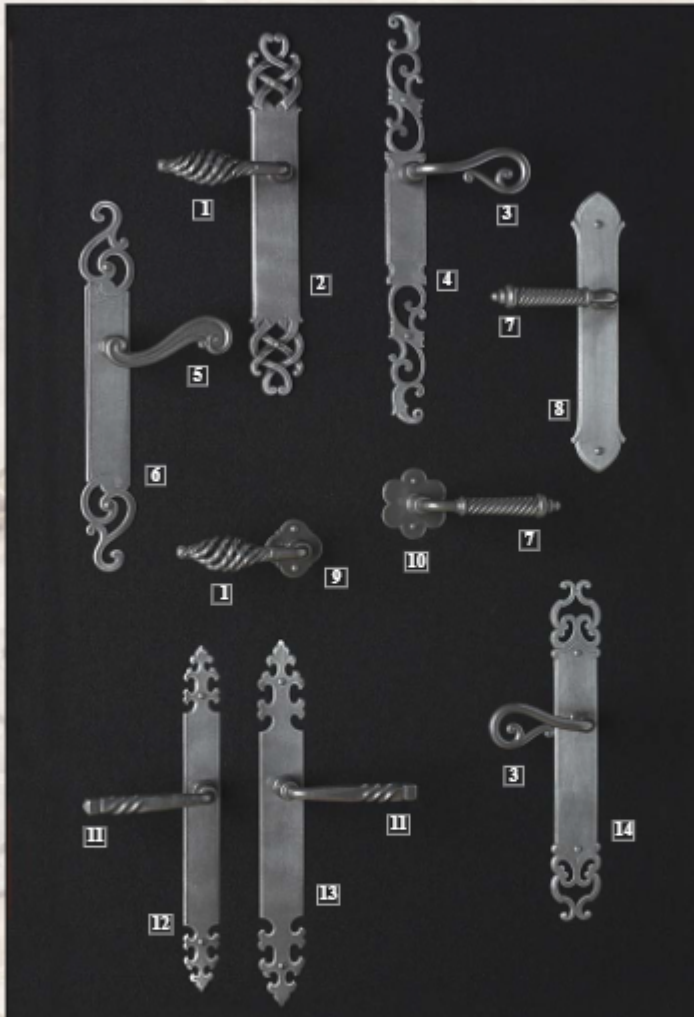

NOTE: Sold in euro pewter and is suitable for outdoor. Euro pewter is a galvanized steel finish.

IRON		A	B	C	IRON		A	B	C
1	31.1027.3			4-1/2"	9	30.2014.3	2-3/8"	2-3/8"	
2	30.1043.3	12-1/8"	1-3/4"		10	30.2013.3	2"	2"	
3	31.1024.3			4-3/16"	11	31.1020.3			4-3/8"
4	30.1045.3	13-3/4"	1-3/8"		12	30.1049.3	11-3/8"	1-3/16"	
5	31.1023.3			4-3/16"	13	30.1048.3	12-3/16"	1-1/2"	
6	30.1044.3	12"	1-3/4"		14	30.1046.3	11-5/8"	1-3/4"	
7	31.1026.3			4-3/4"					
8	30.1050.3	9-1/2"	2"						



IRON DOOR PULLS

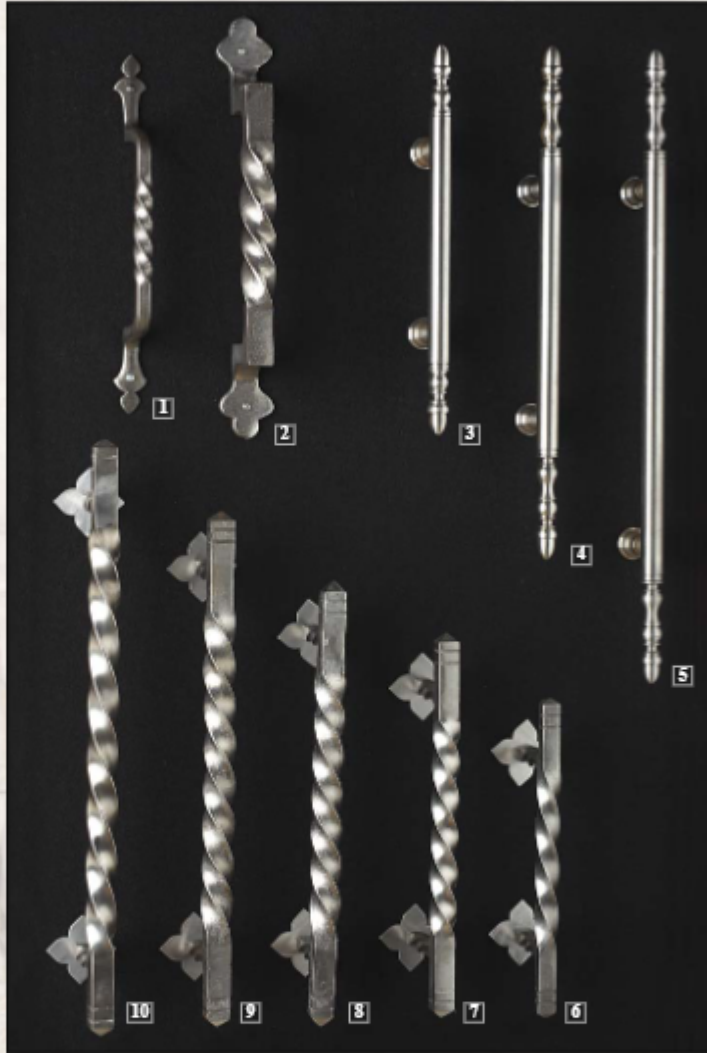

NOTE: Item # 5 is available up to 39-1/2" (1 meter).

IRON		A	B	C	D
1	05.1556.161	10-7/8"	8-3/4"	1-1/16"	2-5/16"
2	19.1380.0331	13"	10-7/8"	3/4"	2-7/8"
3	19.0009.0301	12"	5-9/16"	11/16"	2-1/4"
4	19.0009.0401	16"	7-3/16"	11/16"	2-1/4"
5	19.0009.0501	20"	11-1/8"	11/16"	2-1/4"
6	19.1379.251	9-7/8"	6"	9/16"	2-11/16"
7	19.1379.301	11-5/8"	7-15/16"	5/8"	3"
8	19.1379.351	13-13/16"	9-7/8"	5/8"	3"
9	19.1379.401	15-1/2"	11-13/16"	11/16"	2-5/8"
10	19.1379.451	17-9/16"	16-5/8"	3/4"	3"

IRON PULLS COLLECTION



IRON		A	B	C	D
1	05.68.101	4-3/8"	3-3/4"	5/8"	1-5/8"
2	05.68.121	5-1/2"	5"	5/8"	1-5/8"
3	05.68.161	6-3/4"	6-5/16"	5/8"	1-5/8"
4	19.68.201	8-3/4"	8"	7/8"	2-3/8"
5	19.68.301	12-3/4"	12"	7/8"	2-3/8"
6	19.68.401	16-3/4"	16"	7/8"	2-3/8"

EURO PEWTER DOOR AND OVERSIZE CABINET PULLS

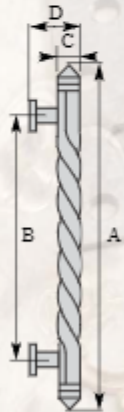
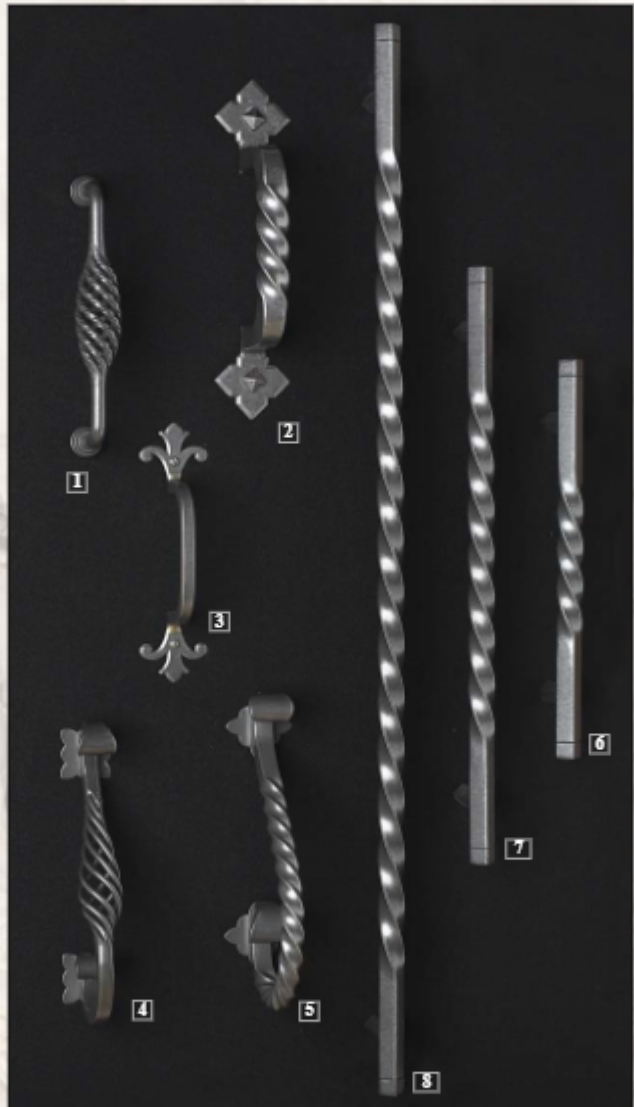

NOTE: Sold in euro pewter which is a galvanized steel and is suitable for outdoor.

IRON		A	B	C	D	IRON		A	B	C	D
1	05.1384.203	9-7/8"	8"	1-1/2"	3"	5	19.38	10"	6-3/4"	3/4"	4-3/4"
2	19.1225.1	11"	8-3/4"	1"	3"	6	19.1378.351	14-3/8"	8-7/8"	7/8"	2-1/2"
3	19.1231.2051	8-1/4"	5-3/4"	3/8"		7	19.1378.501	19-1/2"	15-1/8"	7/8"	2-1/2"
4	19.35.1	9-1/2"	7-1/8"	1-1/2"	3-1/2"	8	19.1378.801	34"	30"	7/8"	2-1/2"

IRON AND EURO PEWTER DOOR KNOCKERS AND IRON NAILS

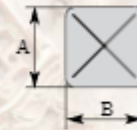
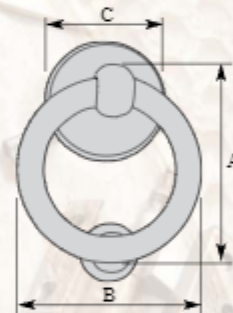

NOTE: Items # 1, 3, 4 and 5 sold in euro pewter which is a galvanized steel and is suitable for outdoor.

IRON		A	B	C	IRON		A	B	C
1	17.1219.1	5-3/8"	5-1/2"	4-1/8"	10	22.5304.251	1"	1"	
2	17.2035.1	4-1/4"	4"		11	22.1583.1	1-1/2"	1-1/2"	
3	17.1242.240	4-13/16"	5-3/8"	6-3/4"	12	22.586.151	5/8"	5/8"	
4	17.1242.261	5-1/2"	6-1/8"	7-5/8"	13	22.586.201	13/16"	13/16"	
5	17.1216.1	4-3/8"	4-7/8"	2-3/8"	14	22.586.251	1"	1"	
6	17.2034.1	5"	4-1/2"	2-3/8"	15	22.586.301	1-1/4"	1-1/4"	
7	17.5108.1	5-1/2"	7-3/16"	5"	16	22.1220.1	1-3/8"	1-3/8"	
8	17.1526.1	5-5/16"	6-1/8"	5"	17	22.1222.1	1-5/16"	1-5/16"	
9	22.5304.201	13/16"	13/16"						

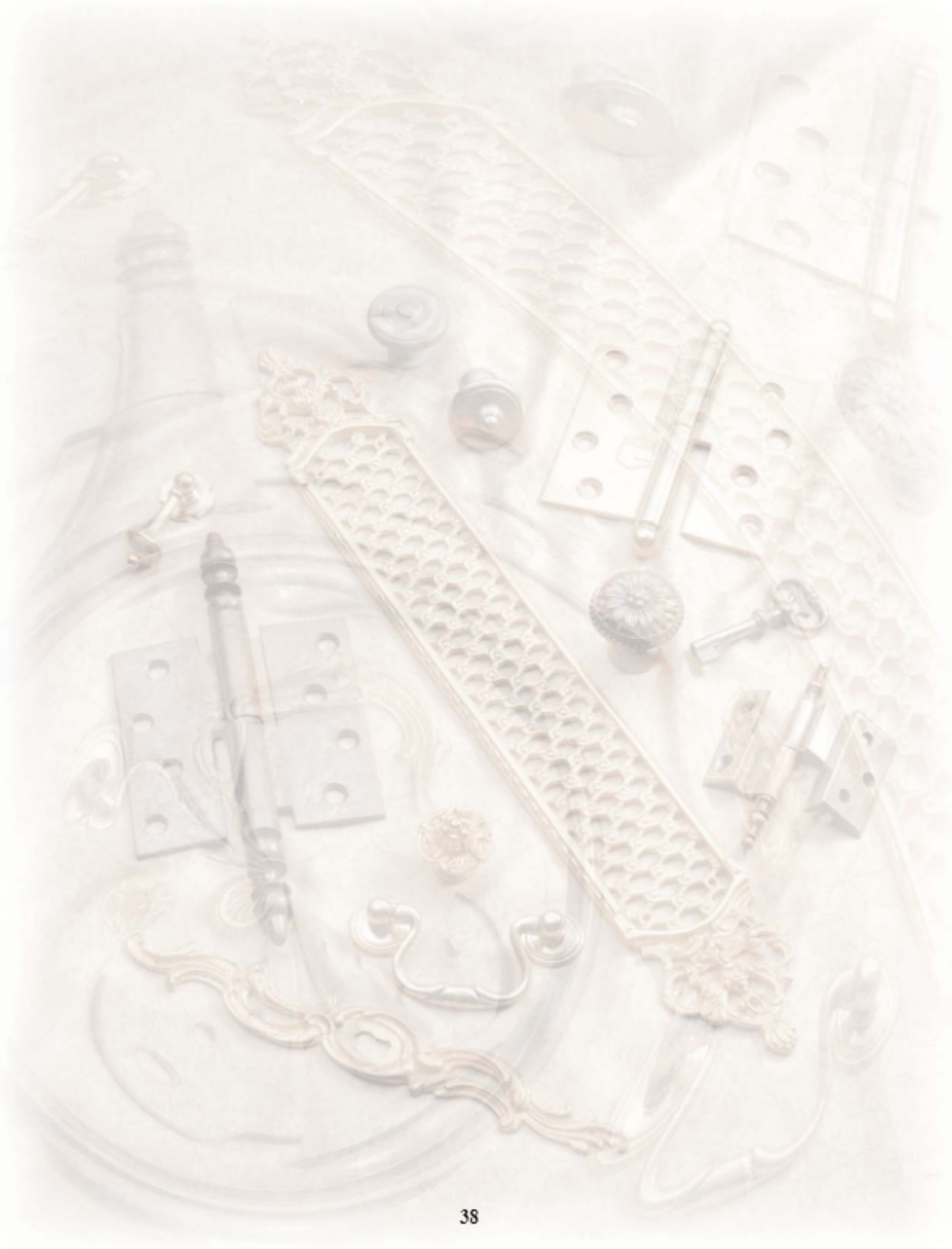

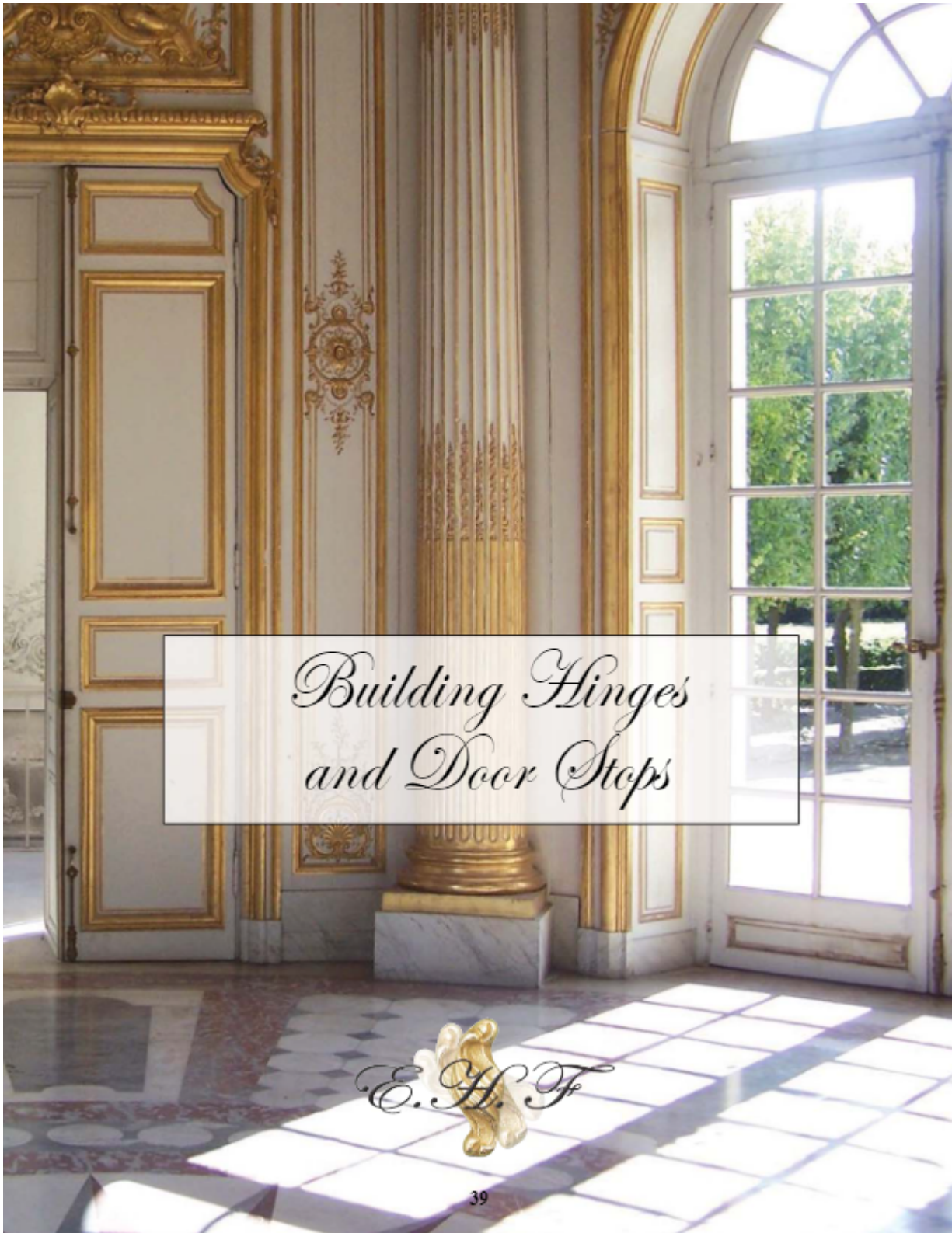

*Building Hinges
and Door Stops*

E.H.F.

FULL MORTISE BRASS BUILDING HINGES



NOTE: Finial caps are available for hinge # 2. See page 41.
 Hinges # 3 and # 4 raise a door 5/8" as it opens.
 Hinges on this page are handed.
 Please specify left or right when ordering.

BRASS	LEFT	RIGHT	A	B	C
1	02.0219.162		2-7/8"	6-1/4"	1/2"
2	02.212.602		4"	6"	1/2"
3	02.1840.402		2-1/8"	2-15/16"	9/16"
4	02.1840.002		2-1/8"	4"	9/16"

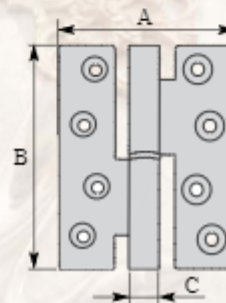

FULL MORTISE BRASS INSET HINGES

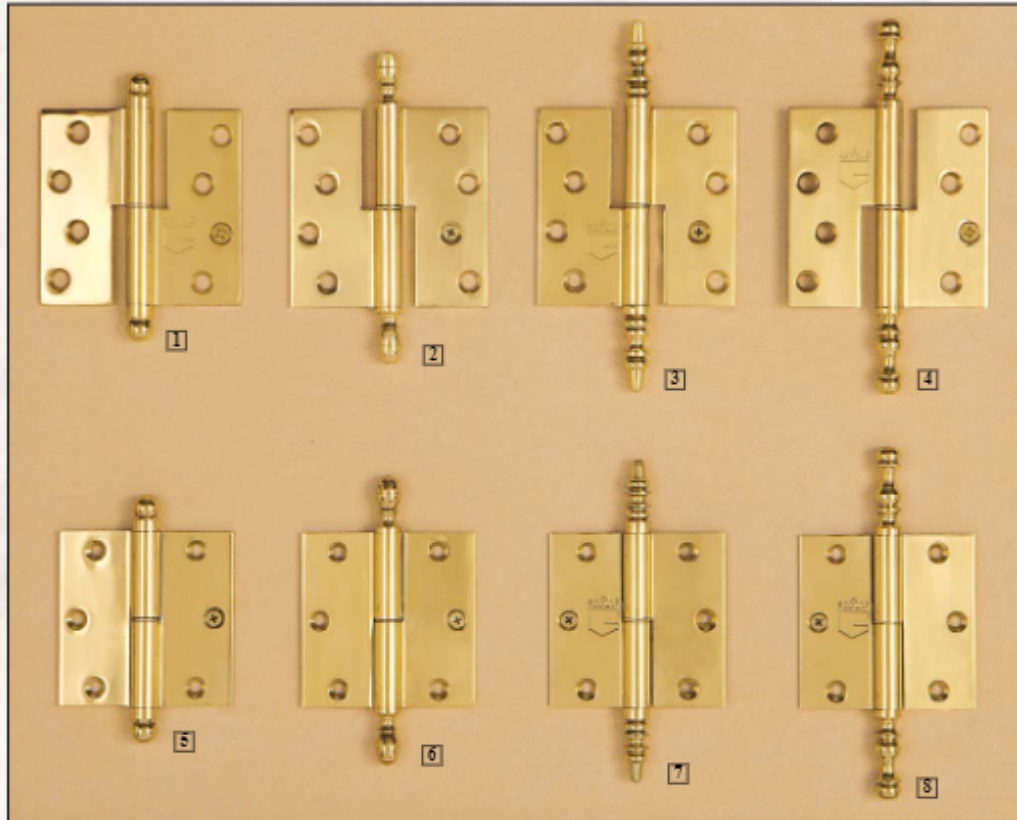

NOTE: Hinges on this page are handed, please specify left or right when ordering.



BRASS	LEFT/RIGHT	A	B	C	D
1	02.0211.442	5-1/2"	4"	4"	9/16"
2	02.0211.422	6-3/8"	4"	4"	9/16"
3	02.0211.432	7-5/8"	4"	4"	9/16"
4	02.0211.412	7-9/16"	4"	4"	9/16"
5	02.0211.342	5"	3-1/2"	3-1/2"	9/16"
6	02.0211.322	5-7/8"	3-1/2"	3-1/2"	9/16"
7	02.0211.332	6-1/2"	3-1/2"	3-1/2"	9/16"
8	02.0211.312	7"	3-1/2"	3-1/2"	9/16"

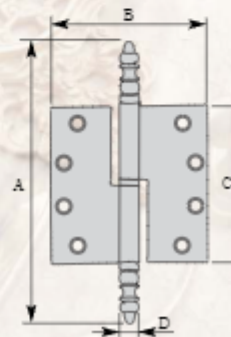



FULL MORTISE IRON INSET HINGES AND OPTIONAL SLIDE-ON CAPS

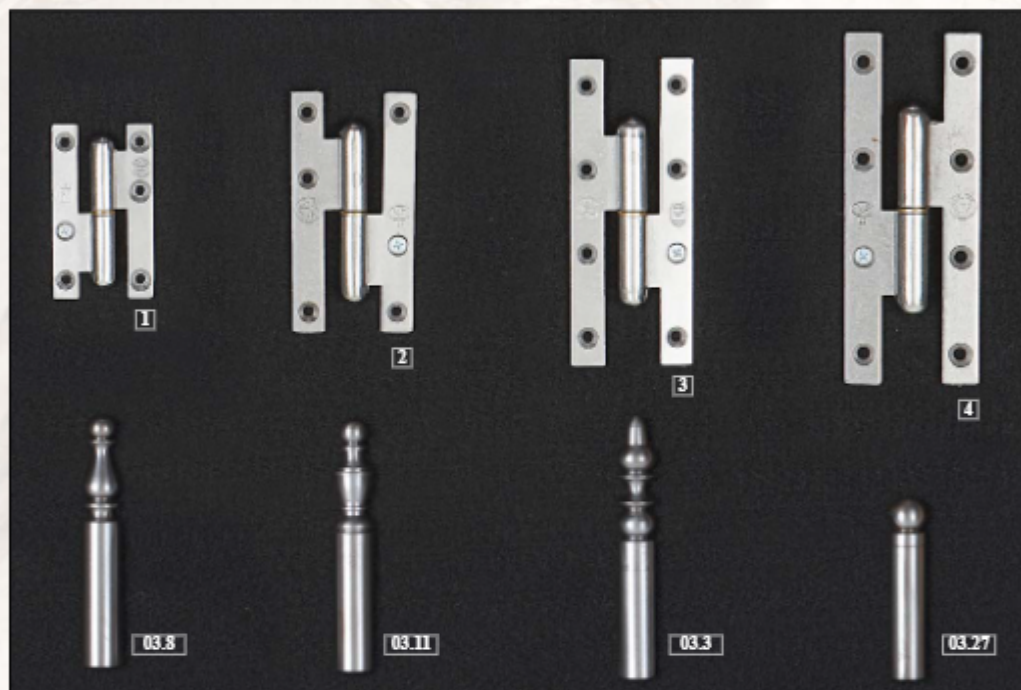

NOTE: Hinges on this page are handed, please specify left or right when ordering.
Caps are optional.



IRON		A	B	C	D	IRON		A	B	C	D
1	02.39.81 L/R	3-1/8"	1/2"	1-3/4"	7/16"	3	02.39.141 L/R	5-1/2"	5/8"	2-3/16"	9/16"
1	with caps 03.3	6-1/4"		1/2"		3	with caps 03.3	7-3/4"			11/16"
1	with caps 03.8	6-1/4"		1/2"		3	with caps 03.8	7-3/4"			11/16"
1	with caps 03.11	6"		1/2"		3	with caps 03.11	7-1/2"			11/16"
1	with caps 03.27	4-1/2"		1/2"		3	with caps 03.27	5-1/4"			11/16"
2	02.39.111 L/R	4-5/16"	9/16"	2-1/8"	1/2"	4	02.39.161 L/R	6-5/16"	5/8"	2-3/16"	9/16"
2	with caps 03.3	7-1/4"		9/16"		4	with caps 03.3	8-1/4"			11/16"
2	with caps 03.8	7-1/4"		9/16"		4	with caps 03.8	8-1/4"			11/16"
2	with caps 03.11	7"		9/16"		4	with caps 03.11	8-1/4"			11/16"
2	with caps 03.27	5-3/4"		9/16"		4	with caps 03.27	6"			11/16"

FULL MORTISE IRON BUILDING HINGES

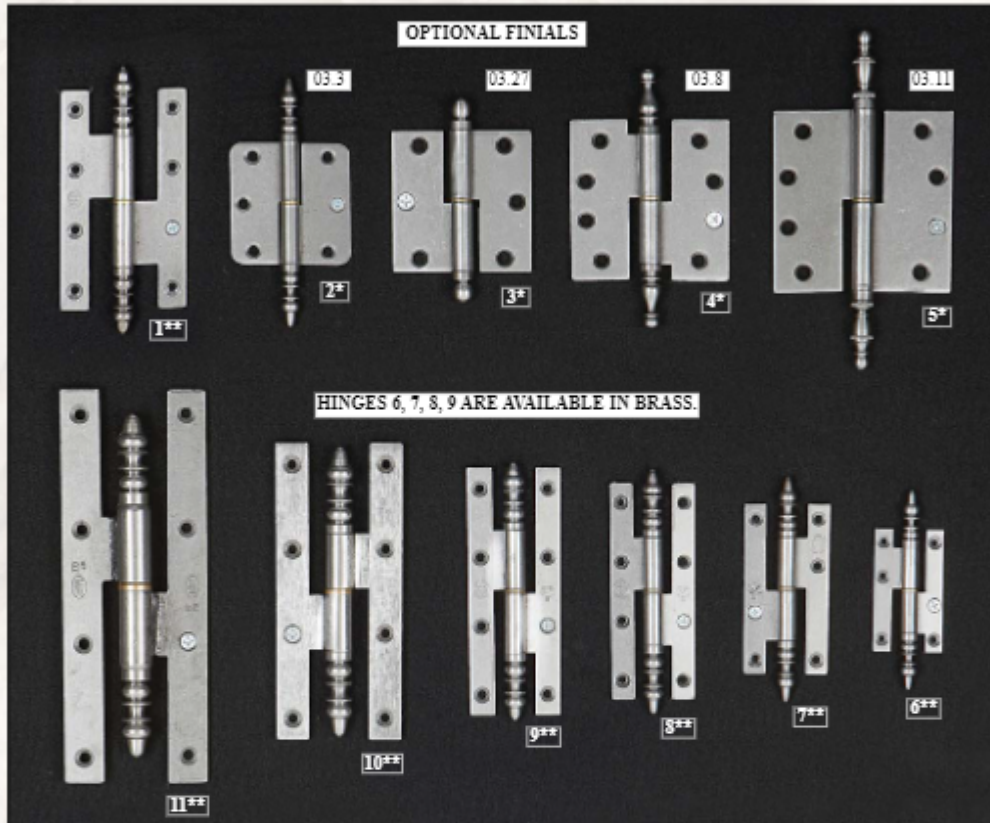

NOTE: Hinges on this page are handed, please specify left or right when ordering.

* All 4 sizes are available with 4 different finial tips.

** Available with ball and standard finial tips only.

"A" measurement is based on our standard finial tip #03.3.

Please specify finial tip.

IRON	LEFT	RIGHT	A	B	C	D	E
1	02.0105.141		6-3/4"	11/16"	3-1/8"	9/16"	5-7/16"
2	02.0210.300		6-1/4"	1-1/4"	3"	1/2"	3"
3	02.0210.350		7"	1-5/16"	3-1/2"	9/16"	3-1/2"
4	02.0210.400		6-3/4"	1-7/16"	4"	9/16"	4"
5	02.0210.450		8"	1-3/4"	4-1/2"	9/16"	4-1/2"
6	02.0103.081		5-1/16"	7/16"	1-3/4"	7/16"	3-1/8"
7	02.0103.111		5-3/4"	9/16"	2-3/16"	9/16"	4-5/16"
8	02.0103.141		6-1/4"	9/16"	2-3/16"	9/16"	5-1/2"
9	02.0103.161		7"	5/8"	2-3/8"	9/16"	6-1/4"
10	02.0059.191		7-1/4"	13/16"	3-1/8"	11/16"	7-7/16"
11	02.0059.251		8-3/4"	1"	3-5/8"	7/8"	9-7/8"

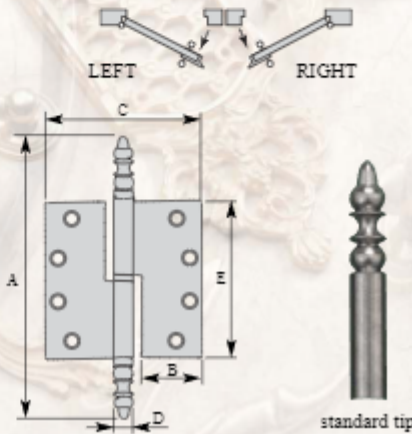



EURO PEWTER STRAP HINGES

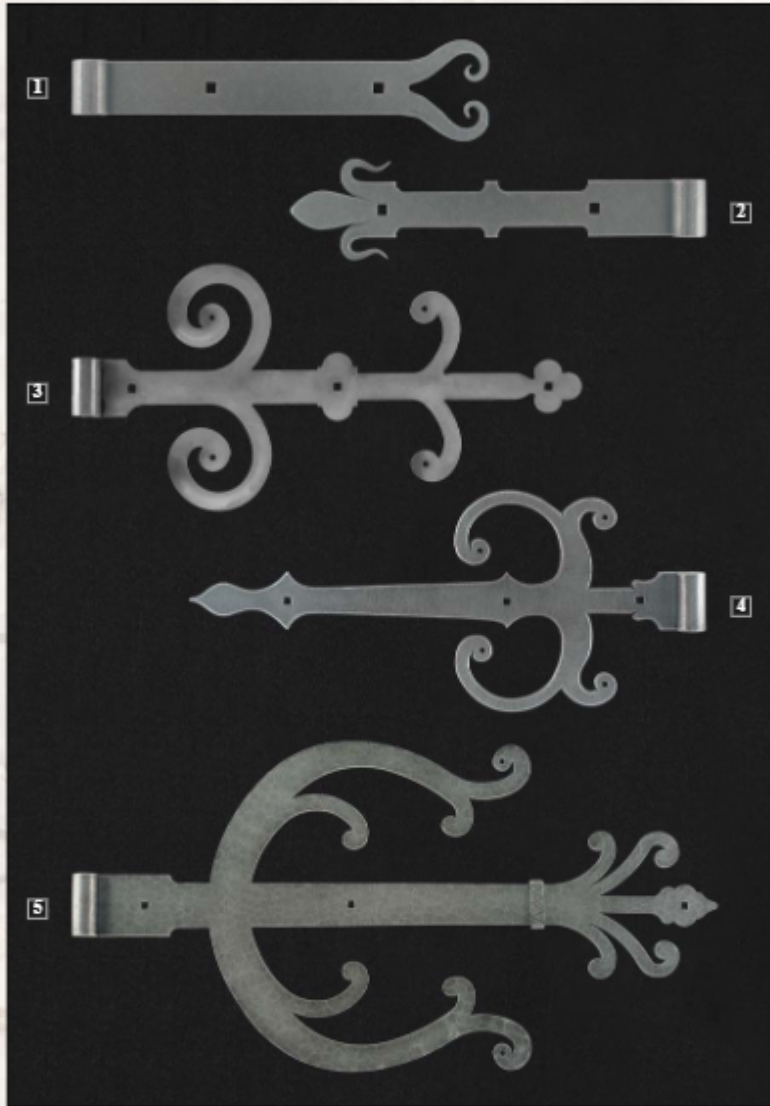

NOTE: # 1 and # 2 available in different lengths up to 39-1/2"

IRON		A	B
1	16.1210.403	15-3/4"	1-1/2"
2	16.1211.403	15-3/4"	1-1/2"
3	16.1274.3	19-3/4"	10"
4	16.1275.3	19-3/4"	8-7/8"
5	16.1272.3	27-1/2"	14-1/2"



EURO PEWTER SHUTTER DOGS AND PINTLES

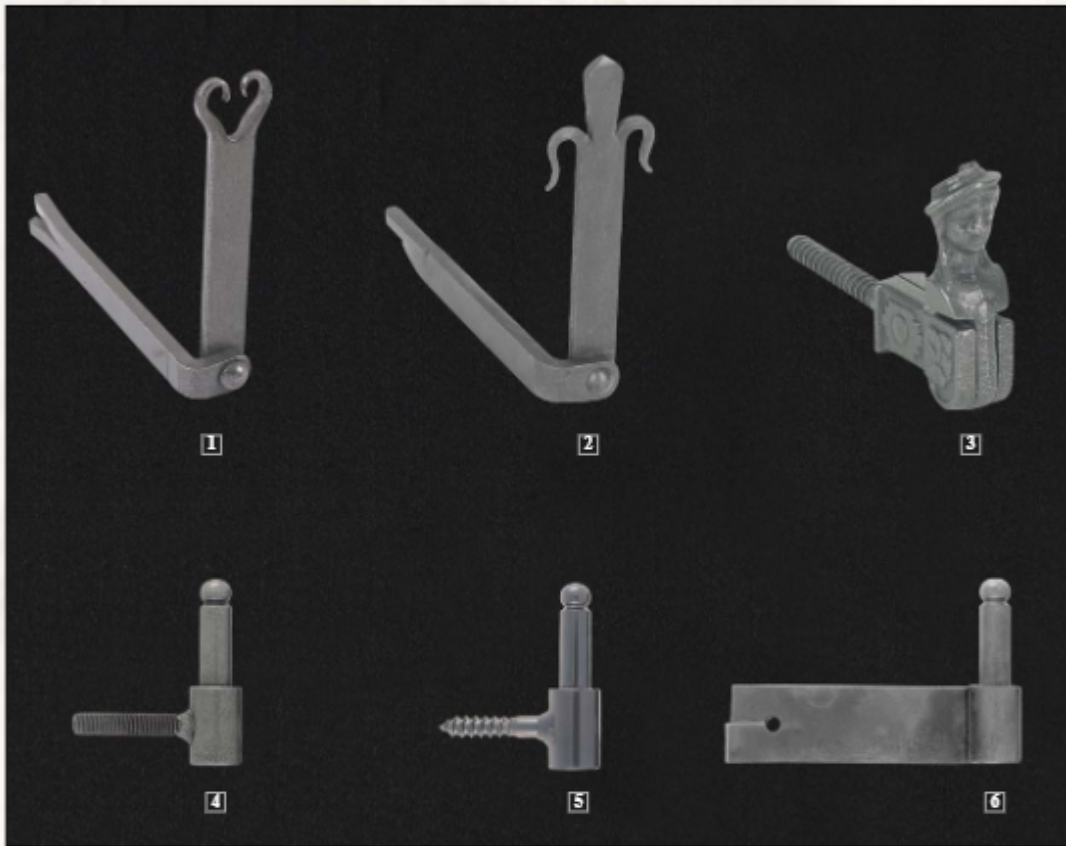

IRON		A	B
1	20.1315.3	5-1/4"	4-1/2"
2	20.1316.3	5-1/4"	4-3/4"
3	20.1310.3	8" masonry	2-3/4"
3	20.1312.3	6" wood	2-3/4"
4	20.1284.123	4-3/4"	1-1/2"
4	20.1284.143	5-1/2"	2-3/8"
5	20.1283.123	2-3/8"	1-1/2"
5	20.1283.143	3-1/8"	2-3/8"
6	20.1280.123	5"	1-1/2"
6	20.1280.143	5"	2-3/8"

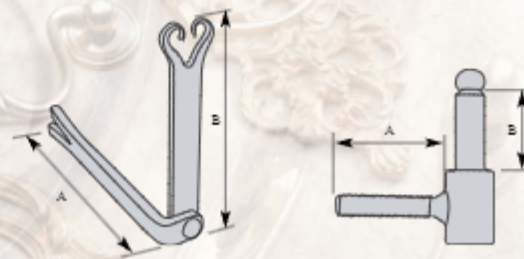



BRASS AND IRON DOOR STOPS

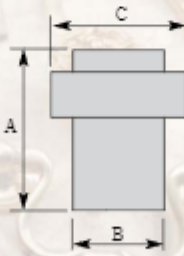

BRASS				IRON					
		A	B	C		A	B	C	
1	30.1934.2	2-1/4"	1-1/8"	1-5/8"	3	30.1752.3	1-3/4"	1-3/16"	1-1/2"
2	30.1307.2	1-3/8"	1"	1-3/8"					





European Hardware and Finishes

Gerber Hinge Co.

16554 Arminta St.
Van Nuys, CA 91406

800.643.7237 | info@gerberhinge.com