













# *Furniture Hardware*

FIFTH EDITION



# Table of Contents

	pages
<b>BRASS HINGES</b>	
OVERLAY .....	4
OVERLAY BARREL HINGES .....	5
FRENCH OVERLAY (FICHE) .....	6
FRENCH OVERLAY/INSET .....	7
NON MORTISE INSET .....	8
FULL MORTISE INSET .....	9-10
3/8" INSET NON-MORTISE .....	11
BRASS AND IRON INSET ARMOIRE HINGES .....	12
<b>IRON HINGES</b>	
OVERLAY .....	13
OVERLAY BARREL HINGES .....	14
FRENCH OVERLAY (FICHE) .....	15
1/4" OVERLAY AND 3/8" INSET .....	16
FRENCH OVERLAY/INSET .....	17
INSET RAT TAIL .....	18
FULL MORTISE INSET .....	19
FULL MORTISE BUILDING HINGES .....	20
FULL MORTISE INSET .....	21
STRAP HINGES .....	22
<b>LOCKS</b>	
FURNITURE LOCKS IN BRASS AND IRON .....	23
FURNITURE LOCKS IN IRON .....	24
<b>KEYS AND FALSE KEYS</b>	
BRASS KEYS .....	25
BRASS FALSE KEYS .....	26-27
IRON KEYS AND FALSE KEYS .....	28
<b>PULLS</b>	
IRON PULLS .....	29 to 39
IRON BIRDCAGE COLLECTION .....	40
BRASS PULLS .....	41 to 53
BRASS BIRDCAGE COLLECTION .....	54
<b>KNOBS</b>	
IRON KNOBS .....	55-56
BRASS KNOBS .....	57 to 60
LOST WAX BRONZE KNOBS .....	61
SAND CAST BRASS KNOBS .....	62

	pages
<b>PENDANTS</b>	
 BRASS PENDANTS .....	63
IRON PENDANTS .....	64
<b>ESCUTCHEONS</b>	
 IRON ESCUTCHEONS .....	65 to 70
BRASS ESCUTCHEONS .....	71 to 76
<b>KEYHOLES</b>	
 BRASS KEYHOLES .....	77 to 79
IRON ESCUTCHEONS AND IRON KEYHOLES .....	80
<b>ROSETTES</b>	
 BRASS ROSETTES .....	81-82
IRON ROSETTES .....	83
<b>BRASS SABOTS AND CASTERS</b> .....	84
	
<b>BRASS HOOKS</b> .....	85
	
<b>BRASS MOULDINGS</b> .....	86-87
	
<b>BRASS MESH GRILLS</b> .....	88
	
<b>IRON COLLECTIONS</b>	
	
FRENCH RUSTED IRON .....	89
BLACKSMITH IRON .....	90
BLACKSMITH IRON ESCUTCHEONS .....	91
ENGLISH BLACK IRON .....	92
CAST IRON .....	93
<b>BRASS COLLECTIONS</b>	
	
ASIAN .....	94
ENGLISH .....	95
LOUIS XIV .....	96
LOUIS XV .....	97
LOUIS XIV AND XV .....	98
KINGS OF FRANCE FURNITURE .....	99
ART NOUVEAU AND ART DECO .....	100
ART DECO .....	101

**MORE SELECTIONS AVAILABLE  
IN OUR BUILDING SECTION**





# OVERLAY BRASS HINGES

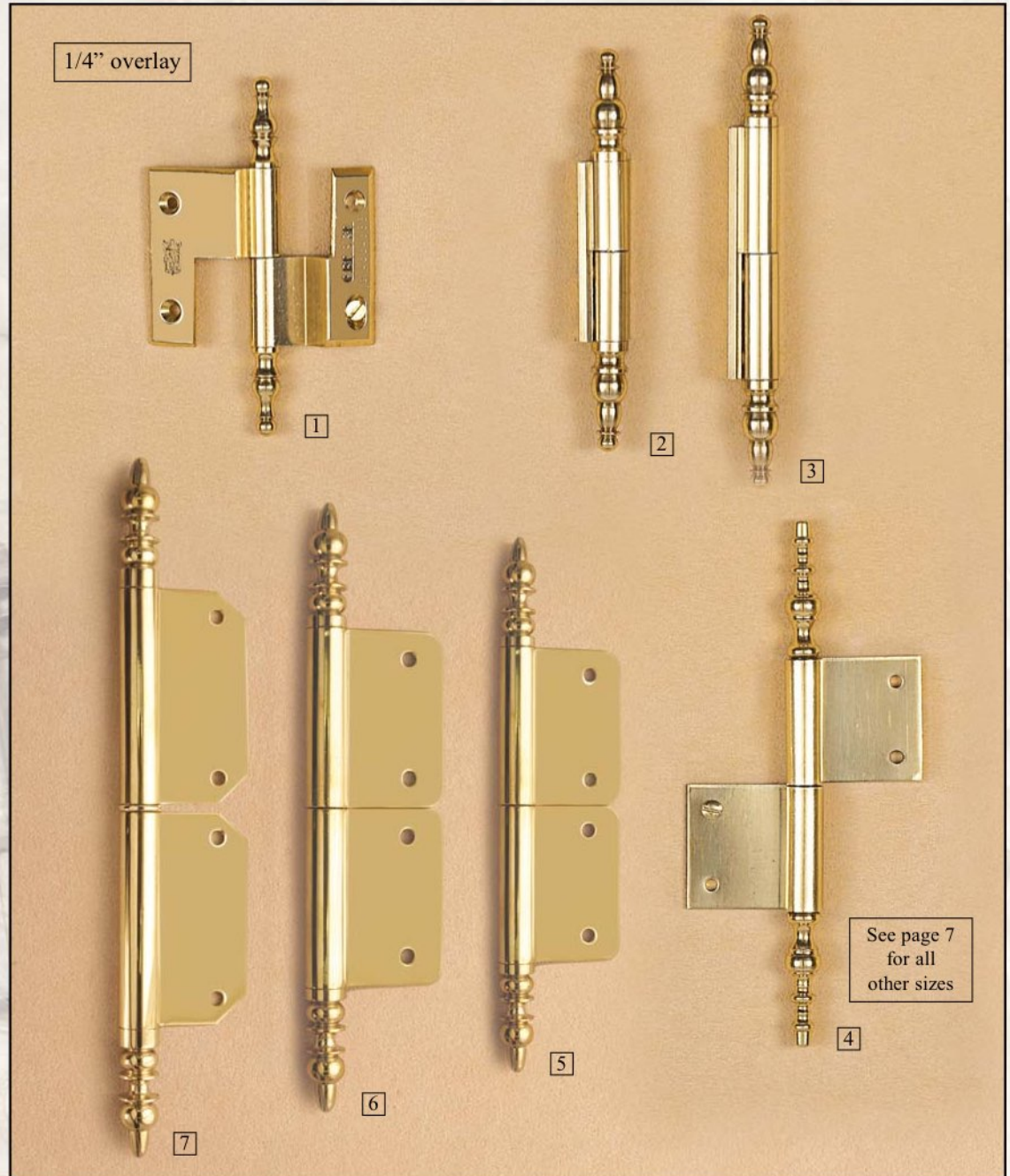
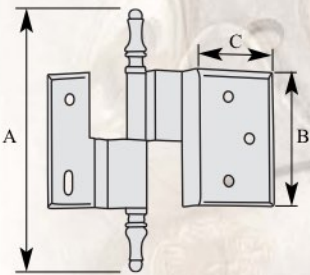
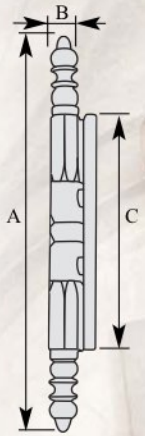
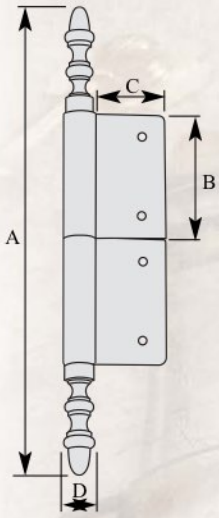

See page 7  
for all  
other sizes

**NOTE:** Hinges # 1 and # 4 on this page are handed, please specify left or right when ordering.

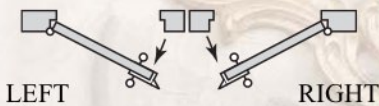

BRASS	LEFT/RIGHT	A	B	C	D
<b>1</b>	01.208	4"	2"	1"	
<b>2</b>	01.272.112	4-3/8"	7/16"	2"	
<b>3</b>	01.272.132	5-3/8"	7/16"	2-3/4"	
<b>4</b>	01.2000.142	5-3/4"	2-11/16"	1"	5/16"
<b>5</b>	01.6.152	5-3/4"	1-5/8"	15/16"	3/8"
<b>6</b>	01.6.172	6-13/16"	2"	1"	7/16"
<b>7</b>	01.6.212	7-1/2"	2-5/16"	1"	3/8"

**HINGE 1 1/4" OVERLAY**

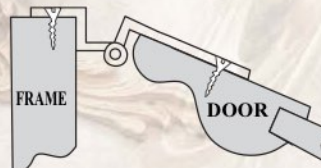

**HINGE 2 3**

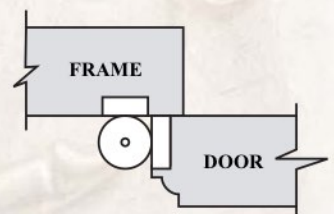

# OVERLAY BRASS BARREL HINGES

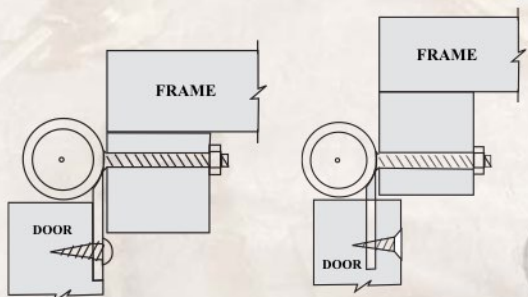

**HINGE #2**  
SCREWS FOR BLADES  
NOT SUPPLIED

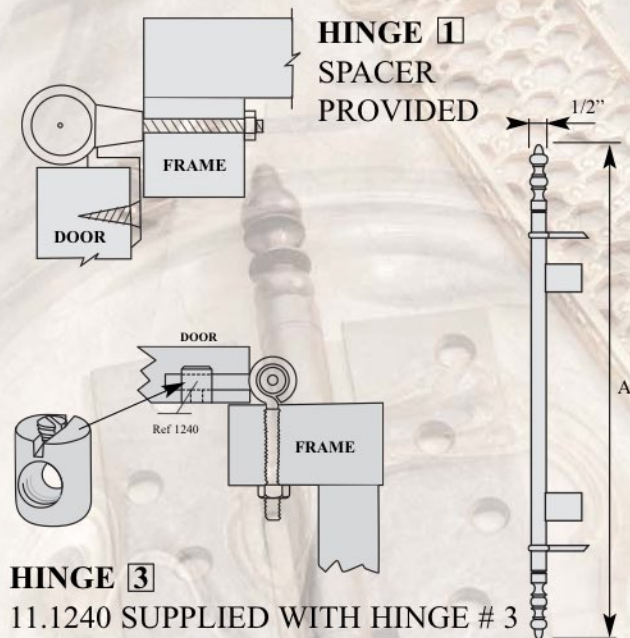

**HINGE #1**  
SPACER  
PROVIDED

**HINGE #3**  
11.1240 SUPPLIED WITH HINGE # 3

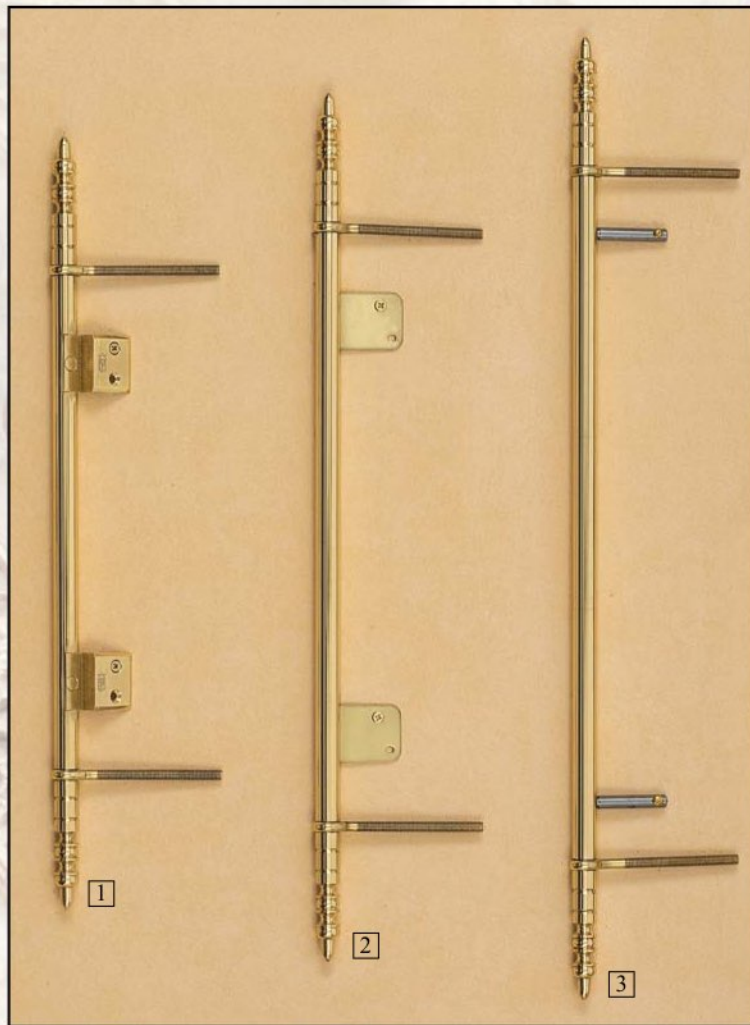

**NOTE:** Hinge # 1 comes handed.  
Please specify left or right when ordering.  
Available as dummies.

BRASS	LEFT/RIGHT	A
1	01.206.20	8"
1	01.206.25	9-13/16"
1	01.206.30	11-13/16"
1	01.206.35	13-13/16"
1	01.206.40	15-13/16"
1	01.206.50	19-11/16"
1	01.206.60	23-11/16"
1	01.206.70	27-5/8"
1	01.206.80	31-5/8"
1	01.206.90	35-1/2"
1	01.206.100	39-9/16"
1	01.206.130	51-1/4"
1	01.206.150	59-3/8"

BRASS	A	
2	01.5.202	8"
2	01.5.252	9-7/8"
2	01.5.302	11-7/8"
2	01.5.352	13-3/4"
2	01.5.402	15-3/4"
2	01.5.452	17-3/4"
2	01.5.502	19-3/4"
2	01.5.602	23-5/8"
2	01.5.702	27-5/8"
2	01.5.802	31-1/2"
2	01.5.902	35-1/2"
2	01.5.1002	39-3/8"
2	01.5.1102	43-5/16"
2	01.5.1302	51-3/16"
2	01.5.1352	53-3/8"
2	01.5.1502	59-5/8"

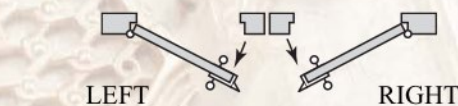

BRASS	A	
3	01.20.202	8-1/2"
3	01.20.302	11-7/8"
3	01.20.402	15-5/8"
3	01.20.502	19-7/16"
3	01.20.552	21-15/16"
3	01.20.1102	43-1/4"
3	01.20.1502	59-1/2"



# FRENCH OVERLAY (FICHE) BRASS HINGES

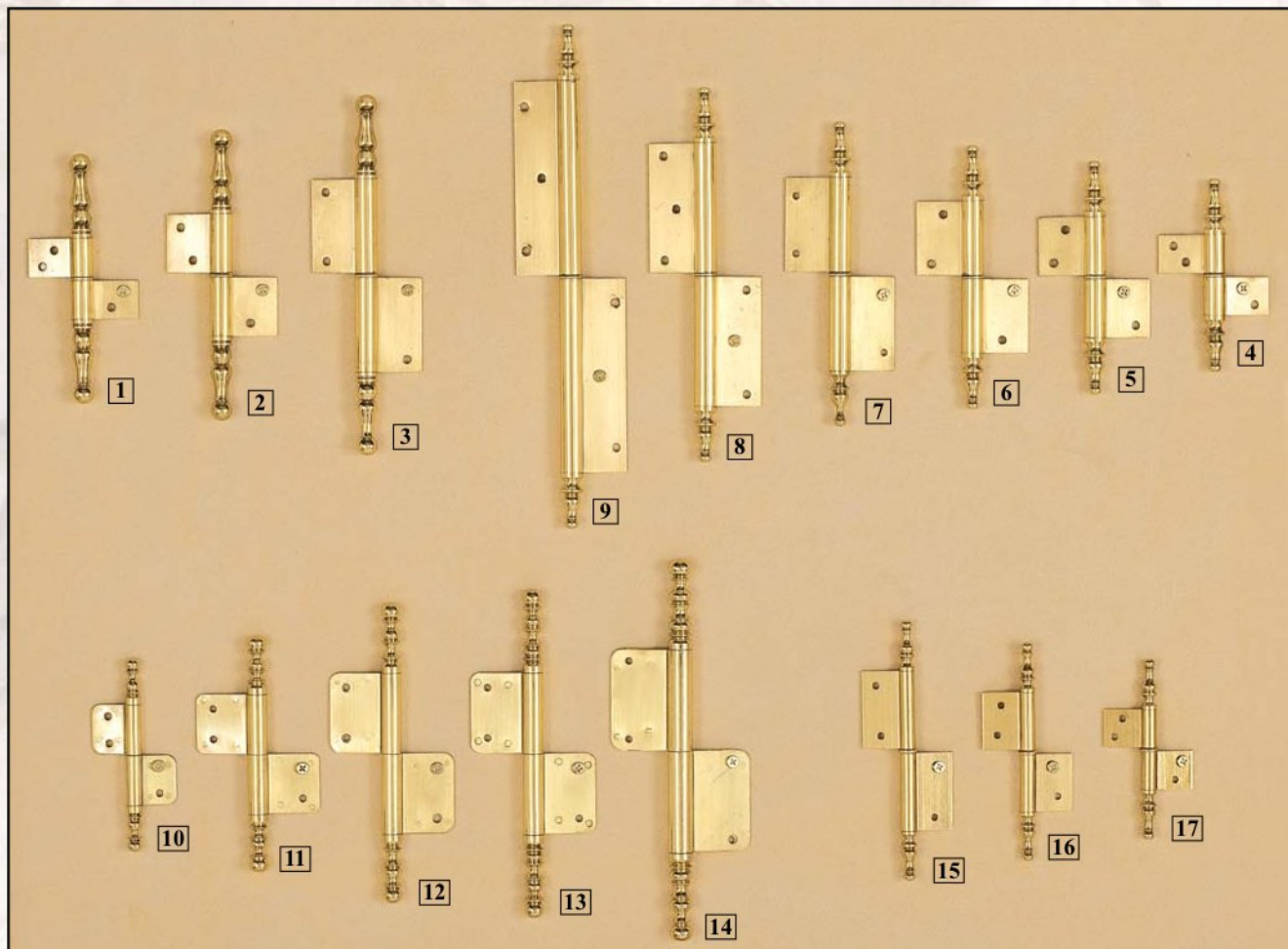

**NOTE:** Screw holes are not countersunk.  
Countersinking available to make these hinges non-mortised inset.

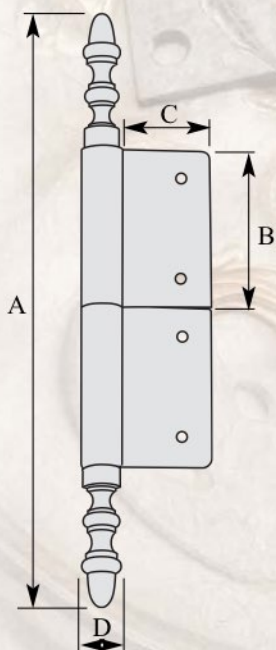

SCREWS NOT SUPPLIED  
WITH THESE HINGE

BLADES ON CENTER  
OF BARREL

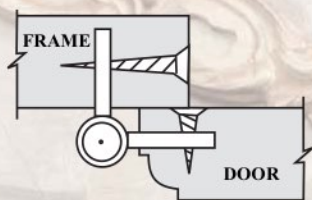

BRASS		A	B	C	D
<b>1</b>	01.212.122	4-15/16"	3/4"	7/8"	7/16"
<b>2</b>	01.212.142	5-3/4"	1-1/8"	7/8"	7/16"
<b>3</b>	01.212.182	7"	1-7/8"	7/8"	7/16"
<b>4</b>	01.214.102	3-3/4"	3/4"	7/8"	7/16"
<b>5</b>	01.214.122	4-9/16"	1-3/16"	7/8"	7/16"
<b>6</b>	01.214.132	5-3/16"	1-7/16"	7/8"	7/16"
<b>7</b>	01.214.152	5-15/16"	1-7/8"	7/8"	7/16"
<b>8</b>	01.214.192	7-3/8"	2-9/16"	7/8"	7/16"
<b>9</b>	01.214.252	9-15/16"	3-3/16"	7/8"	7/16"
<b>10</b>	01.769.92	3-13/16"	1"	11/16"	5/16"
<b>11</b>	01.769.122	4-5/8"	1-3/16"	1"	3/8"
<b>12</b>	01.769.142	5-7/8"	1-9/16"	15/16"	7/16"
<b>13</b>	01.769.162	6-5/16"	1-9/16"	15/16"	7/16"
<b>14</b>	01.769.192	7-1/2"	2"	1"	1/2"
<b>15</b>	01.213.132	5-1/8"	1-9/16"	3/4"	5/16"
<b>16</b>	01.213.112	4-1/4"	1-3/16"	3/4"	5/16"
<b>17</b>	01.213.92	3-9/16"	3/4"	3/4"	5/16"

# FRENCH OVERLAY/INSET BRASS HINGES

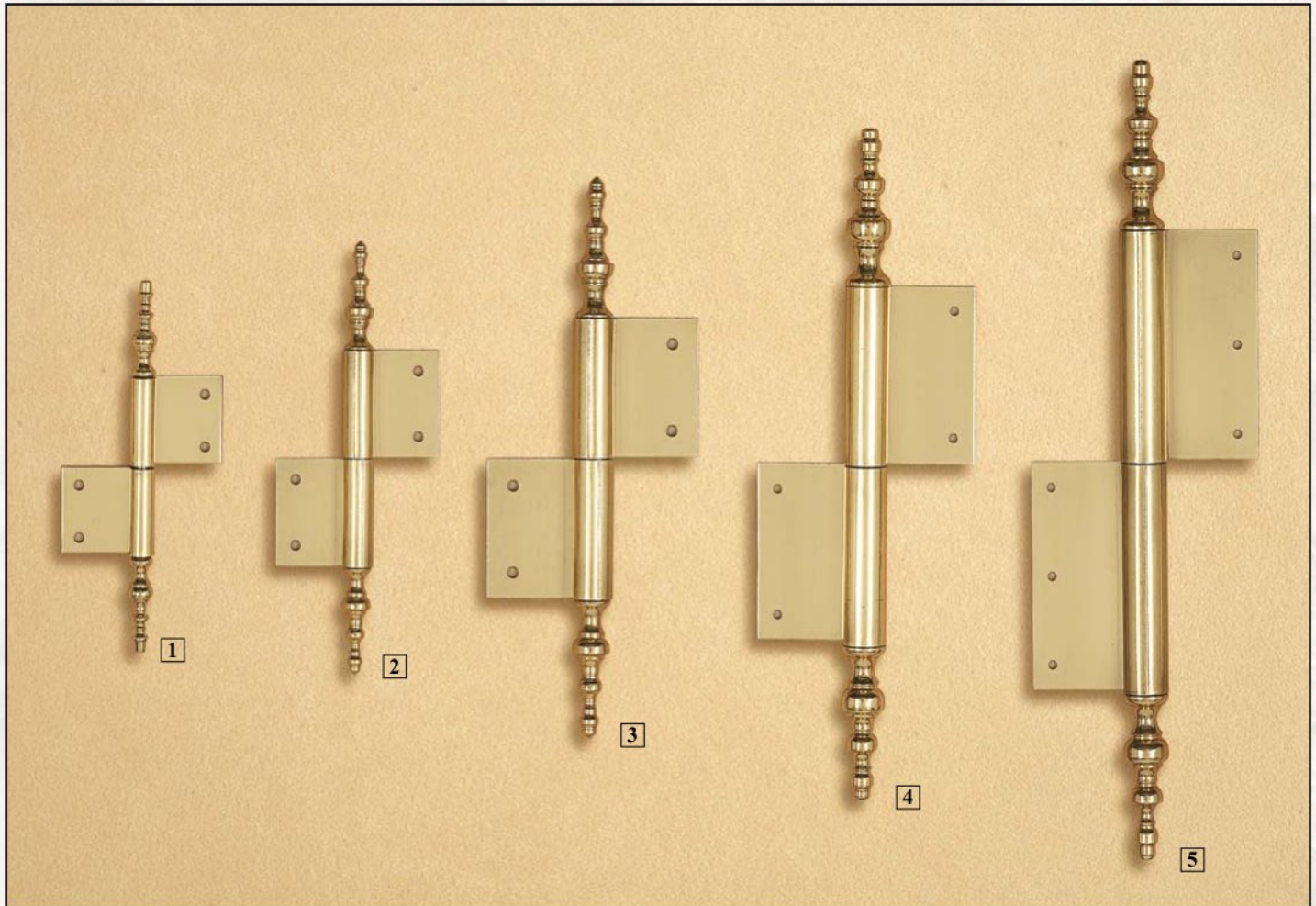

**NOTE:** 2 mounting options inset & overlay. Hinges on this page are handed. When ordering, please specify handing and application option. Countersinking available to make these hinges non-mortised inset.

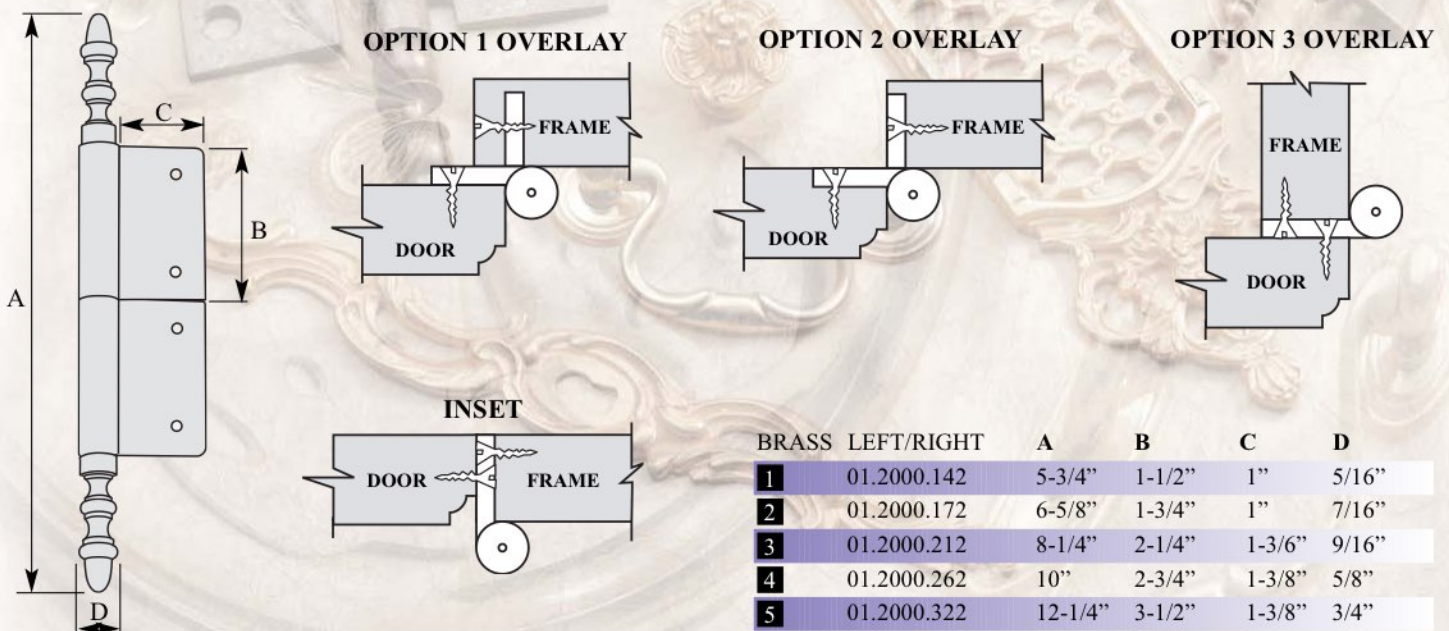



# NON MORTISE BRASS INSET HINGES

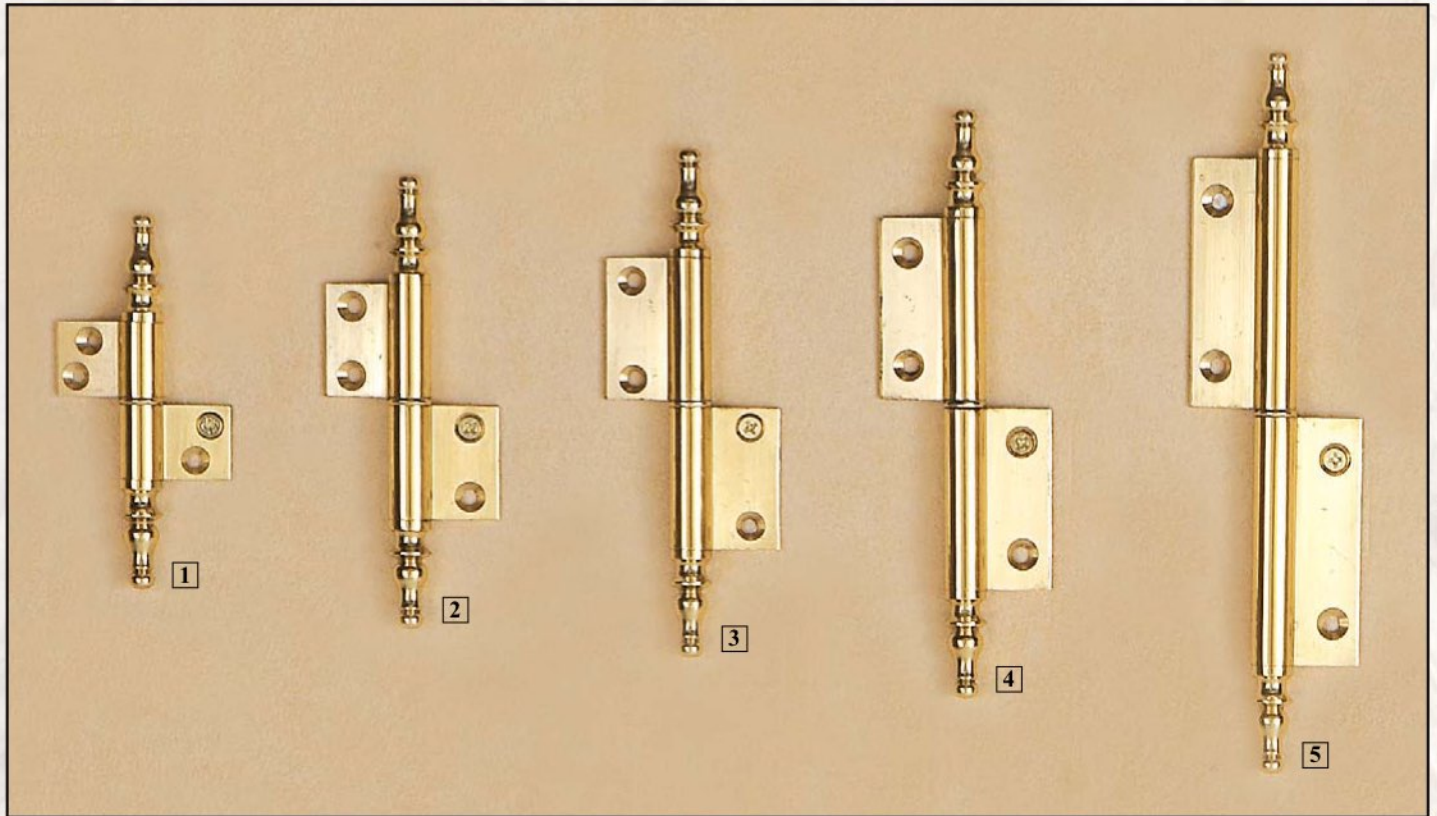

**NOTE:** Hinges on this page are handed, please specify left or right when ordering.  
Philip screws supplied - slotted screws available

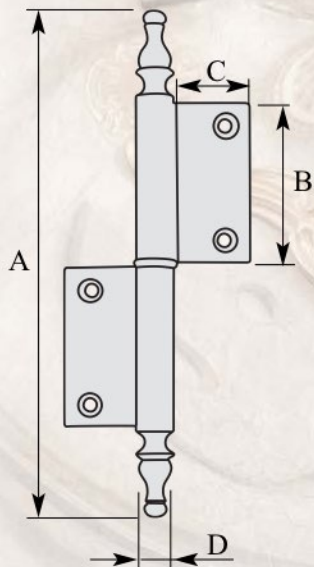
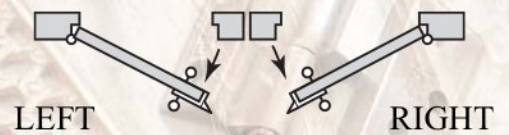

BRASS	LEFT/RIGHT	A	B	C	D
<b>1</b>	01.0217.102	3-3/4"	3/4"	11/16"	7/16"
<b>2</b>	01.0217.122	4-5/8"	1-3/16"	11/16"	7/16"
<b>3</b>	01.0217.132	5-3/16"	1-7/16"	11/16"	7/16"
<b>4</b>	01.0217.152	6"	1-7/8"	11/16"	7/16"
<b>5</b>	01.0217.192	7-3/8"	2-9/16"	11/16"	7/16"

# FULL MORTISE BRASS INSET HINGES

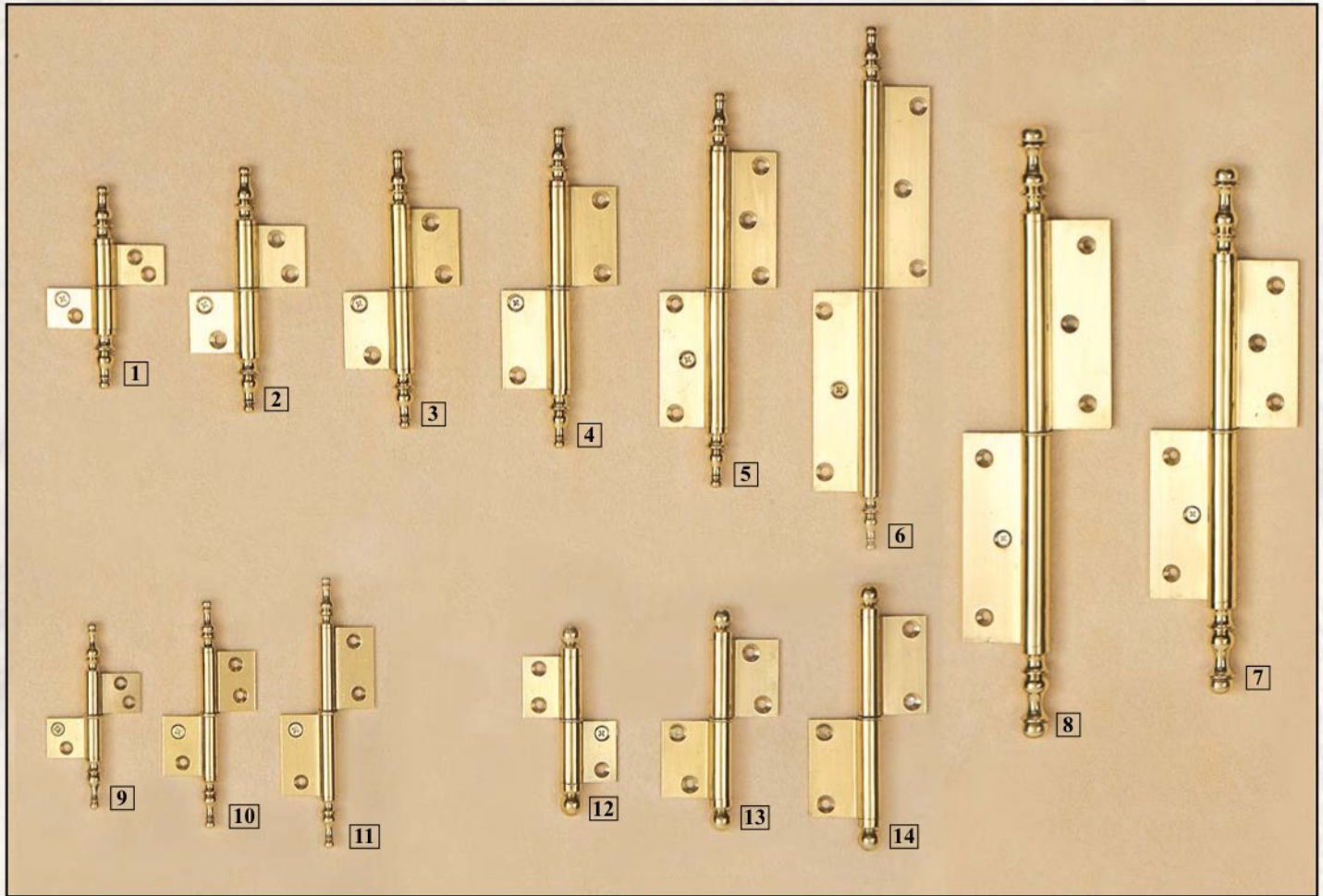

**NOTE:** Hinges on this page are handed, please specify left or right when ordering.  
Philip screws supplied - slotted screws available.

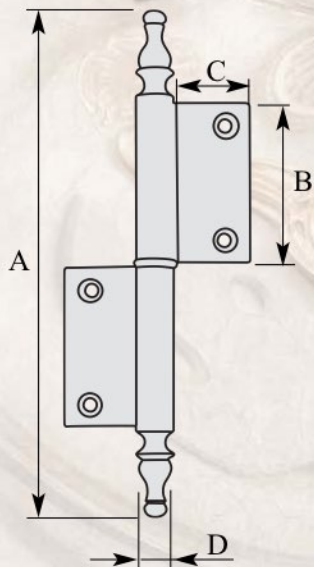
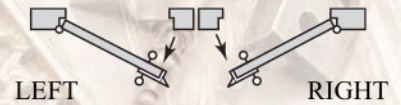

	BRASS	LEFT/RIGHT	A	B	C	D
1	01.215.102		3-3/4"	3/4"	13/16"	7/16"
2	01.215.122		4-5/8"	1-3/16"	13/16"	7/16"
3	01.215.132		5-3/16"	1-1/2"	13/16"	7/16"
4	01.215.152		6"	1-7/8"	7/8"	7/16"
5	01.215.192		7-3/8"	2-9/16"	13/16"	7/16"
6	01.0215.252		9-3/4"	4"	13/16"	7/16"
7	01.215.250		9-15/16"	3-3/16"	1-1/16"	9/16"
8	01.215.290		11-1/2"	3-15/16"	1-1/16"	9/16"
9	01.216.92		3-9/16"	3/4"	3/4"	5/16"
10	01.216.112		4-3/8"	1-3/16"	3/4"	5/16"
11	01.216.132		5-1/8"	1-9/16"	3/4"	5/16"
NOT SHOWN	01.218.102		3"	1-1/8"	13/16"	7/16"
12	01.218.122		3-1/2"	1-3/16"	13/16"	7/16"
13	01.218.132		4-1/4"	1-1/2"	13/16"	7/16"
14	01.218.152		5"	1-7/8"	13/16"	7/16"



# FULL MORTISE BRASS INSET HINGES

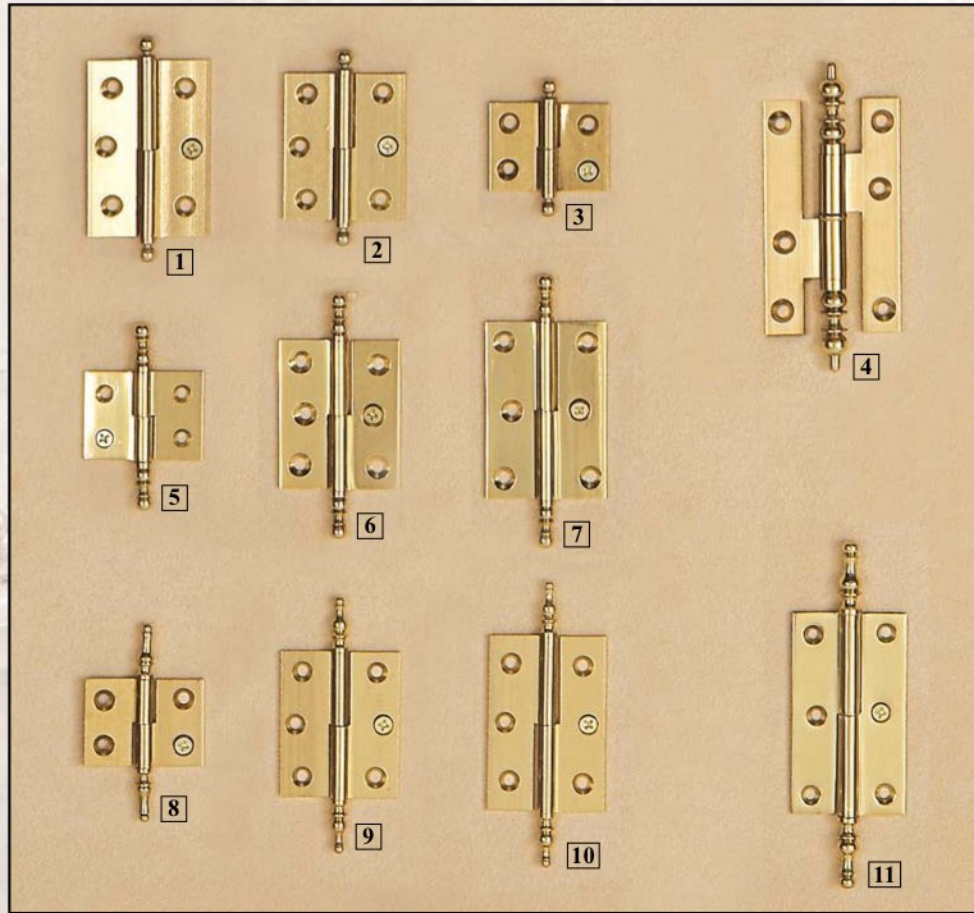

**NOTE:** Hinges on this page are handed, please specify handing when ordering.  
Philip screws supplied - slotted screws available.

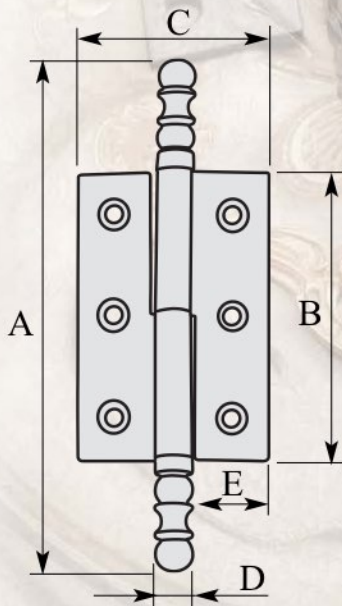

	BRASS LEFT/RIGHT	A	B	C	D	E	
	<b>1</b>	01.7.102	3"	2-3/8"	1-9/16"	1/4"	5/8"
	<b>2</b>	01.7.92	2-5/8"	2"	1-9/16"	1/4"	5/8"
	<b>3</b>	01.7.72	1-7/8"	1-1/4"	1-9/16"	1/4"	5/8"
	<b>4</b>	02.0103.082	4-3/16"	3-1/8"	1-13/16"	3/8"	1/2"
	<b>5</b>	01.4.72	2-9/16"	1-1/4"	1-9/16"	1/4"	5/8"
	<b>6</b>	01.4.92	3-5/16"	2"	1-9/16"	1/4"	5/8"
	<b>7</b>	01.4.102	3-11/16"	2-3/8"	1-9/16"	1/4"	5/8"
	NOT SHOWN	01.4.132	4"	2-3/4"	1-1/2"	5/16"	5/8"
	NOT SHOWN	01.7.132	3-1/2"	2-3/4"	1-1/2"	5/16"	5/8"
	<b>8</b>	01.8.72	2-11/16"	1-3/16"	1-9/16"	1/4"	5/8"
	<b>9</b>	01.8.92	3-1/2"	1-15/16"	1-9/16"	1/4"	5/8"
	<b>10</b>	01.8.102	3-7/8"	2-3/8"	1-9/16"	1/4"	5/8"
	<b>11</b>	01.9.132	4-3/4"	2-3/4"	1-1/2"	5/16"	5/8"

# 3/8" INSET NON-MORTISE BRASS HINGES



**NOTE:** Hinges on this page are handed, please specify handing when ordering.  
Philip screws supplied - slotted screws available.

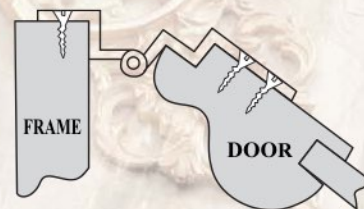
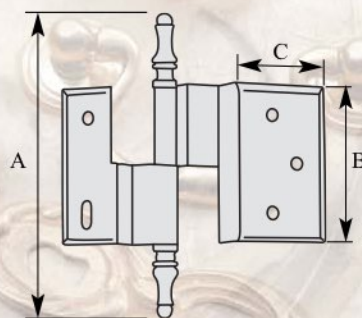

BRASS	LEFT/RIGHT	A	B	C
<b>1</b>	01.201	3-1/16"	1-5/8"	7/8"
<b>2</b>	01.203	4"	2"	7/8"
<b>3</b>	01.207	6"	2"	7/8"

BRASS	LEFT/RIGHT	A	B	C
<b>4</b>	01.0204.702	5"	2"	7/8"
<b>5</b>	01.0204.302	3-1/16"	2"	7/8"
<b>6</b>	01.0204.202	2-1/4"	1-5/8"	7/8"

# BRASS AND IRON INSET ARMOIRE HINGE

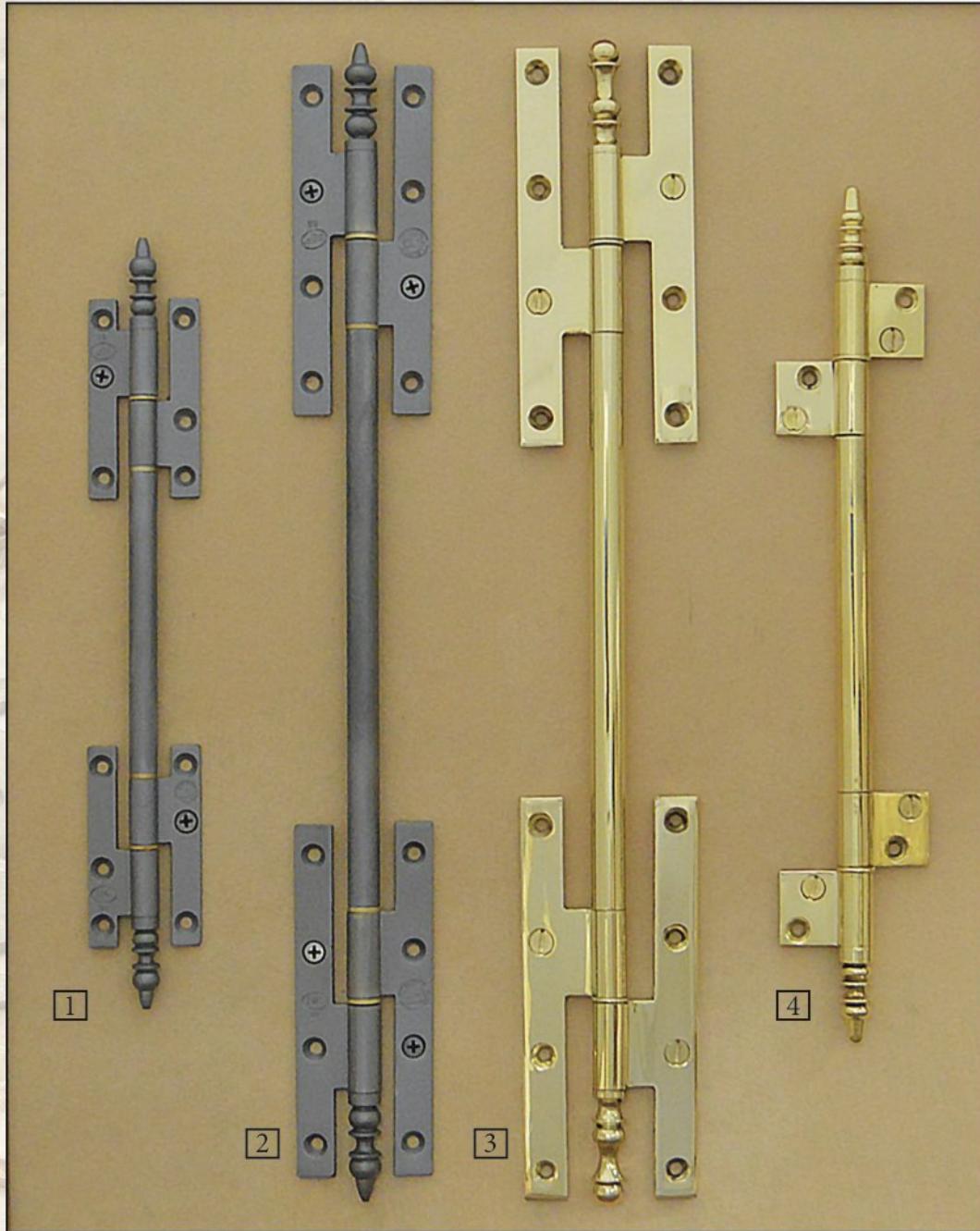

**NOTE:** Custom made armoire hinges cut to your specification. However these have to be within the length guidelines below.

	Part number	Length	Width	Barrel Diameter
<b>1</b>	02.0106.81	8" to 42"	1-3/4"	7/16"
<b>2</b>	02.0106.1	13" to 49"	2-1/8"	1/2"
<b>3</b>	02.219.2	16" to 84"	2-11/16"	9/16"
<b>4</b>	01.211.2	12" to 80"	2-3/8"	9/16"

# OVERLAY IRON HINGES

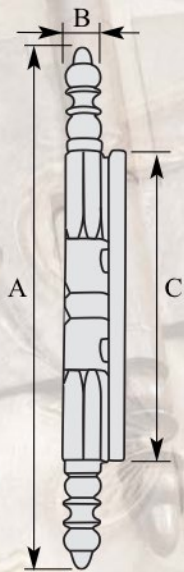
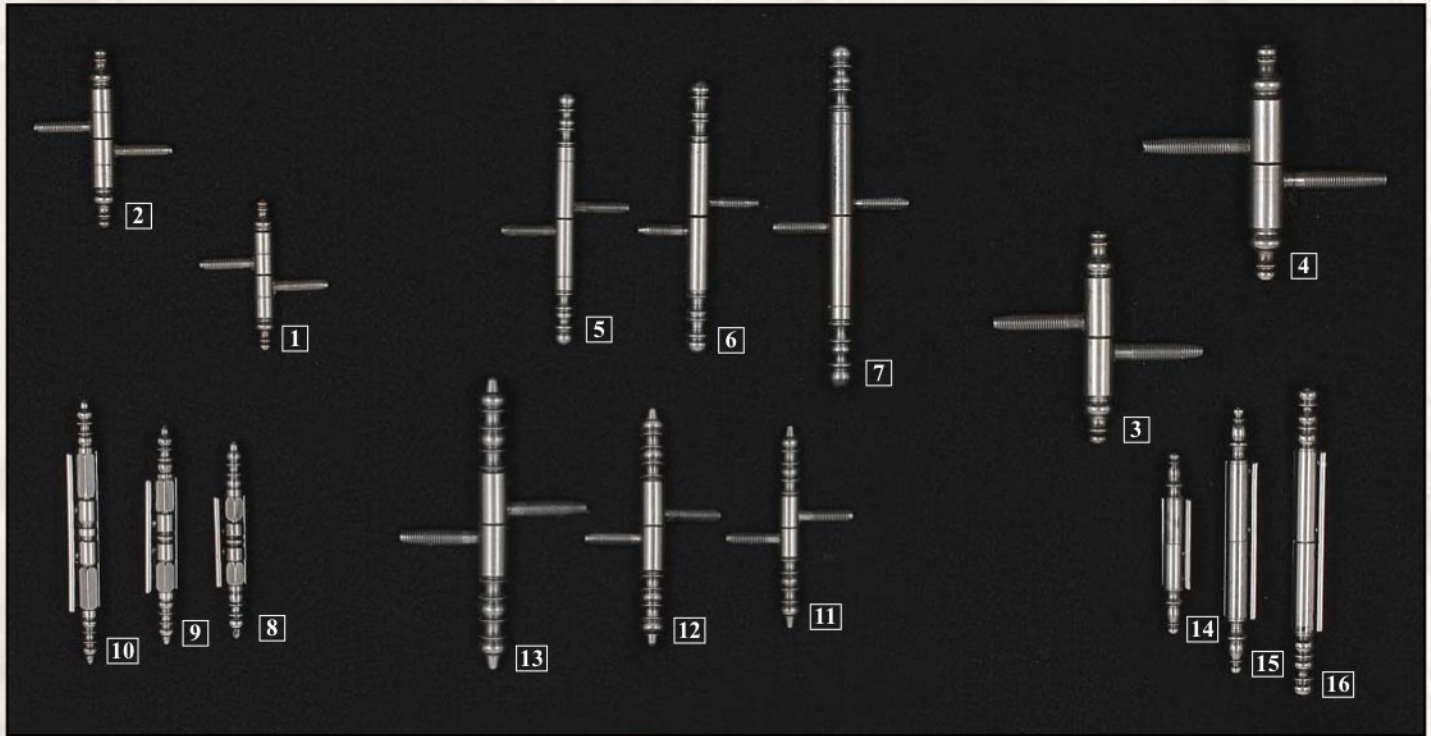

FOR HINGES # 8, 9, 10, 14, 15 and 16.

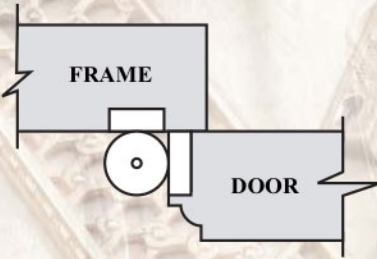

DEPENDING ON PREFERENCE YOU CAN MORTISE OR SURFACE MOUNT.  
ALL OTHER HINGES ARE SCREWED-IN TYPES (SELF-TAPING)

IRON		A	B	C
<b>1</b>	01.101.661	2-5/8"	3/8"	7/8"
<b>2</b>	01.101.781	3"	7/16"	1"
<b>3</b>	01.101.951	3-3/4"	9/16"	1-9/16"
<b>4</b>	01.101.1001	4"	5/8"	1-7/8"
<b>5</b>	01.0501.111	4-3/8"	3/8"	7/8"
<b>6</b>	01.0501.121	4-3/4"	13/32"	7/8"
<b>7</b>	01.0501.151	6"	7/16"	1"
<b>8</b>	01.567.91	3-7/16"	5/16"	1-1/2"

IRON		A	B	C
<b>9</b>	01.567.101	3-7/8"	5/16"	2"
<b>10</b>	01.567.121	4-11/16"	5/16"	2-3/4"
<b>11</b>	01.100.091	3-9/16"	5/16"	1"
<b>12</b>	01.100.101	4-3/16"	3/8"	1"
<b>13</b>	01.100.131	5-1/8"	1/2"	1-3/8"
<b>14</b>	01.15.91	3-3/16"	5/16"	1-5/8"
<b>15</b>	01.15.121	4-3/4"	3/8"	2-3/4"
<b>16</b>	01.15.131	5-1/2"	3/8"	3-1/8"



# OVERLAY IRON BARREL HINGES

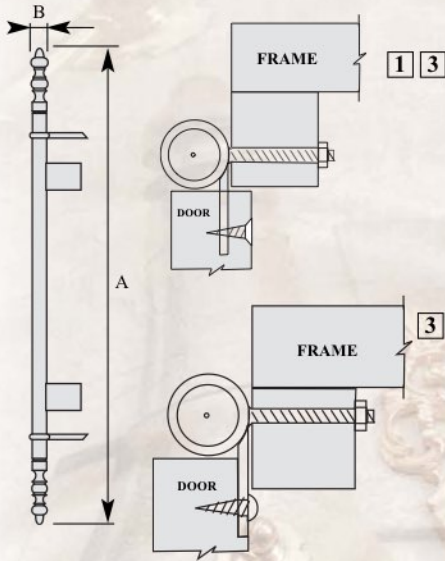

SCREWS NOT SUPPLIED FOR HINGES # 1 AND # 3

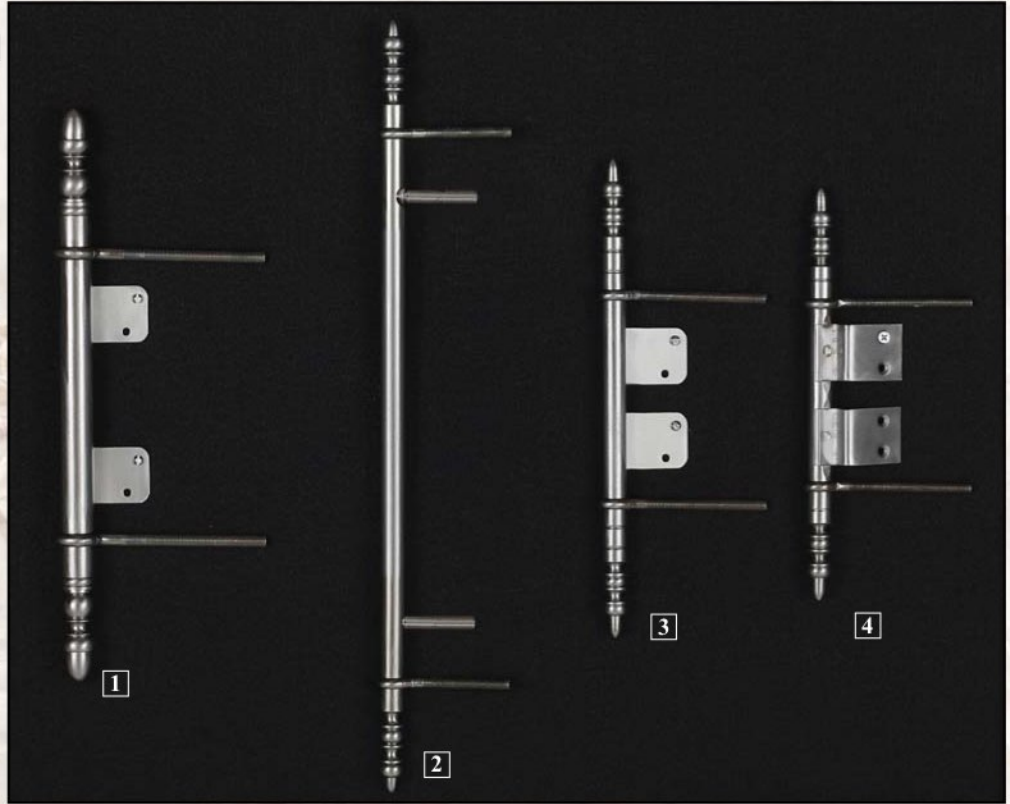

**NOTE:** Hinge # 2 can be cut to size, maximum length is 40".  
Hinge # 1 can also be ordered in custom lengths

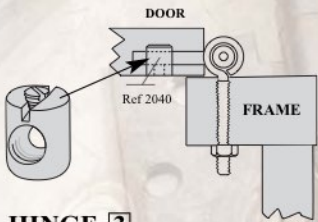

**HINGE #3**  
11.2040 SUPPLIED WITH HINGE # 2

IRON		A	B
<b>1</b>	01.0190.0301	12"	11/16"
<b>2</b>	01.20.201	8-1/2"	
<b>2</b>	01.20.302	11-7/8"	
<b>2</b>	01.20.402	15-5/8"	
<b>2</b>	01.20.502	19-7/16"	
<b>2</b>	01.20.552	21-15/16"	
<b>2</b>	01.20.1102	43-1/4"	
<b>2</b>	01.20.1502	59-1/2"	
<b>3</b>	01.5.201	8"	1/2"
<b>3</b>	01.5.251	9-7/8"	1/2"
<b>3</b>	01.5.301	11-7/8"	1/2"
<b>3</b>	01.5.351	13-3/4"	1/2"
<b>3</b>	01.5.401	15-3/4"	1/2"
<b>3</b>	01.5.451	17-3/4"	1/2"
<b>3</b>	01.5.501	19-3/4"	1/2"
<b>3</b>	01.5.601	23-5/8"	1/2"
<b>3</b>	01.5.701	27-5/8"	1/2"

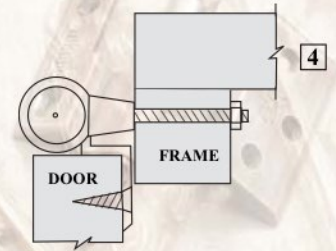
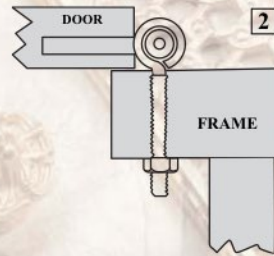

SPACER PROVIDED

IRON		A	B
<b>3</b>	01.5.801	31-1/2"	1/2"
<b>3</b>	01.5.901	35-1/2"	1/2"
<b>3</b>	01.5.1001	39-3/8"	1/2"
<b>3</b>	01.5.1101	43-5/16"	1/2"
<b>3</b>	01.5.1301	51-3/16"	1/2"
<b>3</b>	01.5.1351	53-3/8"	1/2"
<b>3</b>	01.5.1501	59-5/8"	1/2"
<b>4</b>	01.0206.0201	8-1/2"	1/2"
<b>4</b>	01.0206.0251	10-1/2"	1/2"
<b>4</b>	01.0206.0351	14-3/8"	1/2"
<b>4</b>	01.0206.0451	18"	1/2"

IRON		A	B
<b>4</b>	01.0206.0551	21-3/4"	1/2"
<b>4</b>	01.0206.0601	23-1/8"	1/2"
<b>4</b>	01.0206.0701	28"	1/2"
<b>4</b>	01.0206.0801	32"	1/2"
<b>4</b>	01.0206.0901	35-3/4"	1/2"
<b>4</b>	01.0206.1001	39-3/8"	1/2"
<b>4</b>	01.0206.1101	43-1/8"	1/2"
<b>4</b>	01.0206.1201	46-7/8"	1/2"
<b>4</b>	01.0206.1301	50-5/8"	1/2"
<b>4</b>	01.0206.1401	54-1/2"	1/2"
<b>4</b>	01.0206.1501	59-1/2"	1/2"

# FRENCH OVERLAY IRON (FICHE) HINGES

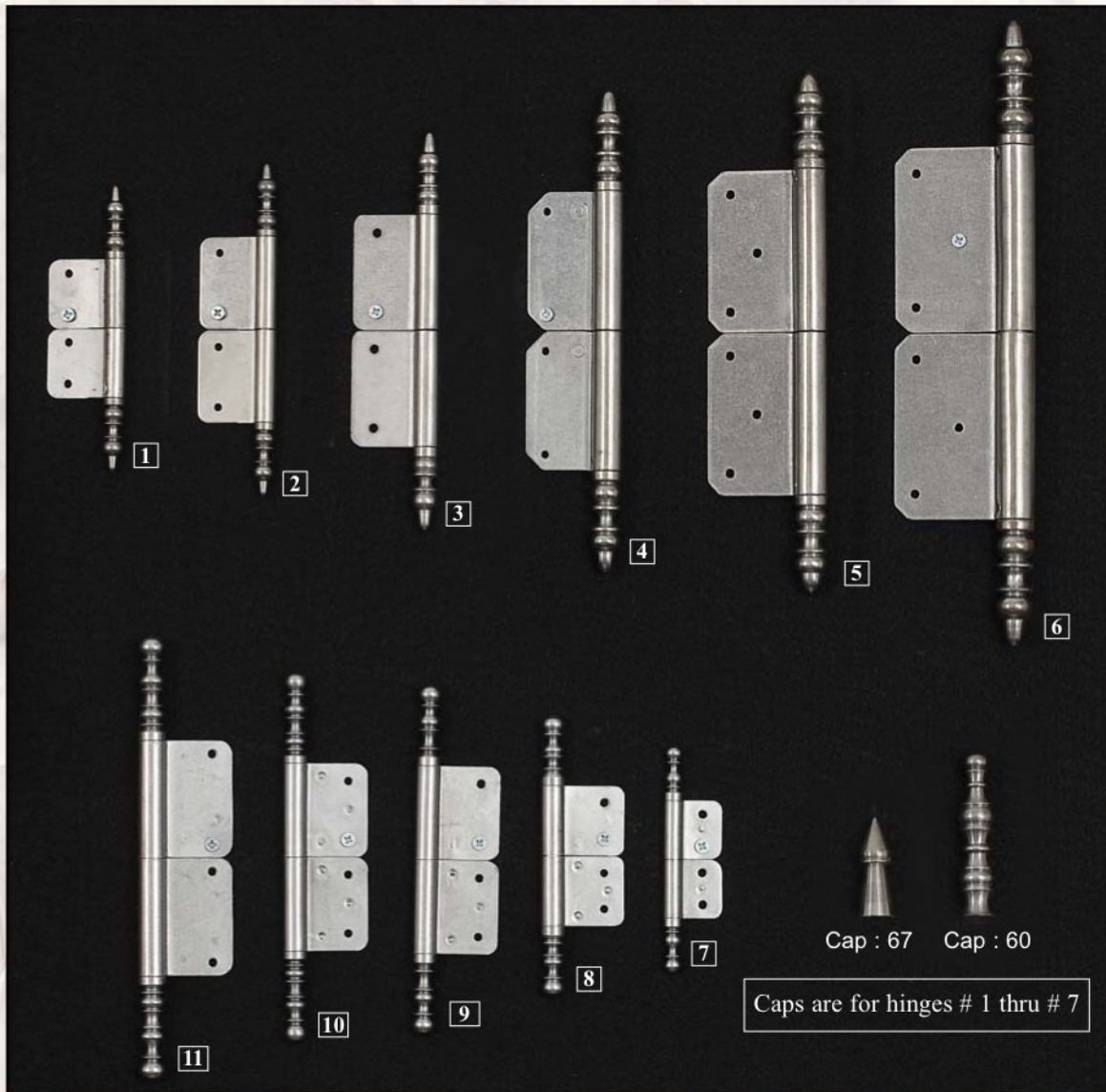

**NOTE:** Screw holes are not countersunk for inset application. Screws are not supplied with these hinges.  
Countersinking available to make these hinges non-mortised inset.

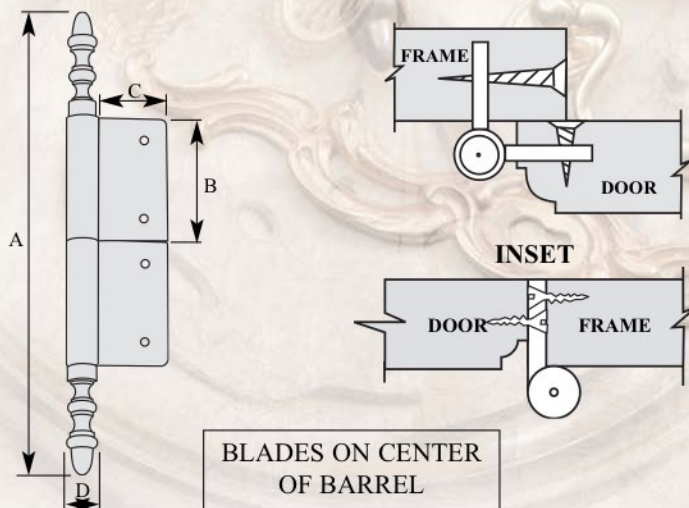

IRON		A	B	C	D
1	01.6.121	4-15/16"	1-3/16"	15/16"	3/8"
2	01.6.151	5-3/4"	1-5/8"	15/16"	3/8"
3	01.6.171	6-13/16"	2"	1"	7/16"
4	01.6.211	8-1/8"	2-3/8"	1-1/16"	1/2"
5	01.6.231	8-7/8"	2-13/16"	1-7/16"	9/16"
6	01.6.271	10-9/16"	3-3/16"	1-11/16"	5/8"
7	01.769.91	3-13/16"	1"	11/16"	5/16"
8	01.769.121	4-5/8"	1-3/16"	1"	3/8"
9	01.769.141	5-7/8"	1-9/16"	15/16"	7/16"
10	01.769.161	6-5/16"	1-9/16"	15/16"	7/16"
11	01.769.191	7-1/2"	2"	1"	1/2"



# 1/4" OVERLAY AND 3/8" INSET IRON HINGES

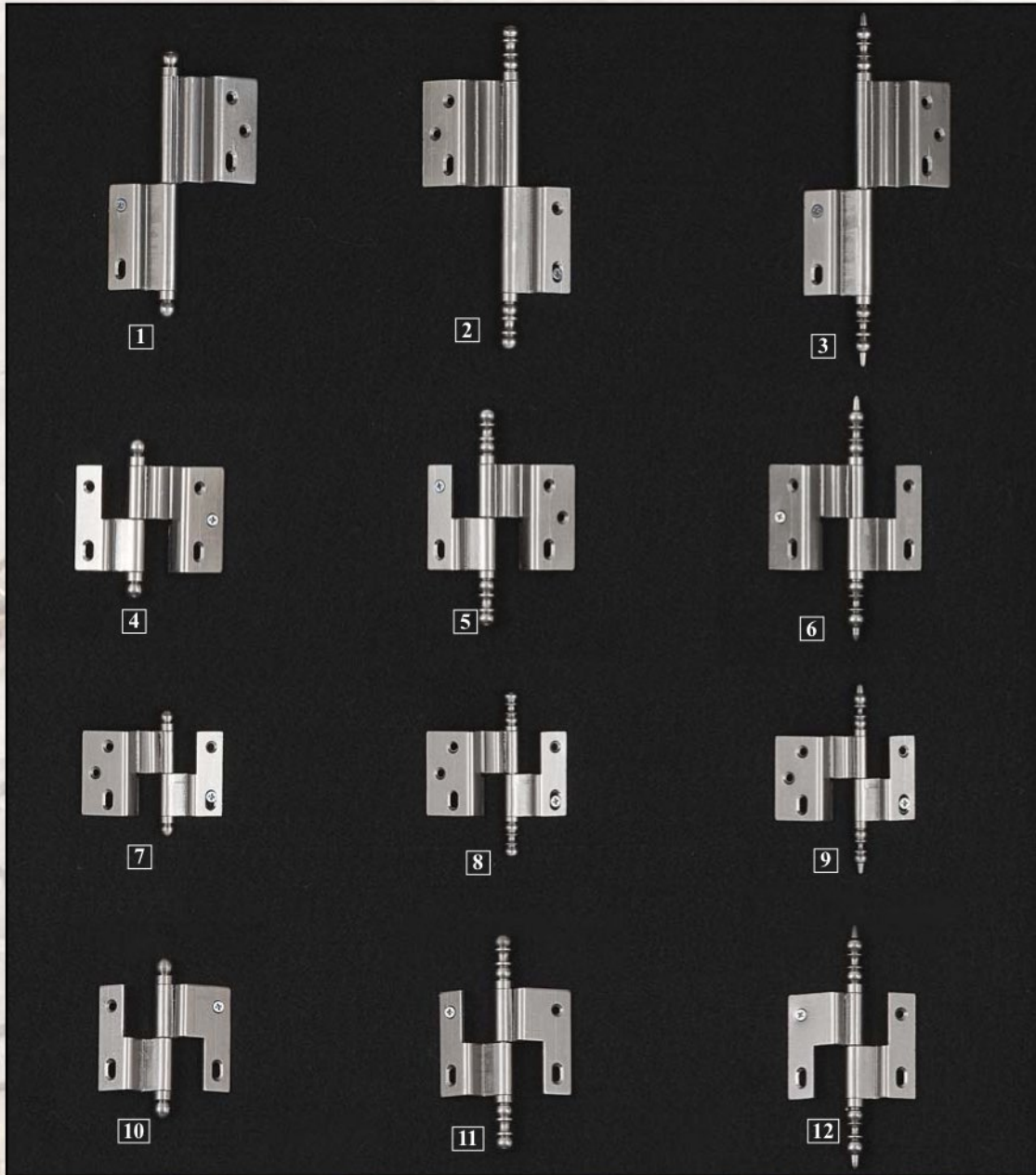

**NOTE:**

Hinges # 10, # 11, # 12 overlay the frame by 1/4 inch with no lip on the door.  
Hinges on this page are handed, please specify left or right when ordering.

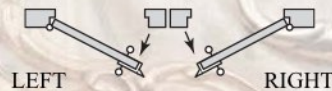
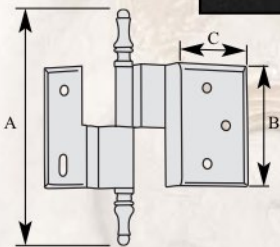

1/4" OVERLAY



3/8" INSET

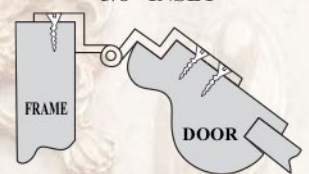

IRON	LEFT/RIGHT	A	B	C
<b>1</b>	01.0204.701	5"	2"	7/8"
<b>2</b>	01.0207.041	6-1/8"	2"	7/8"
<b>3</b>	01.0207.091	6-5/8"	2"	7/8"
<b>4</b>	01.0204.301	3"	2"	7/8"
<b>5</b>	01.0203.041	4-1/8"	2"	7/8"
<b>6</b>	01.0203.091	4-9/16"	2"	7/8"

IRON	LEFT/RIGHT	A	B	C
<b>7</b>	01.0204.201	2-1/4"	1-5/8"	7/8"
<b>8</b>	01.0201.041	3-1/8"	1-5/8"	7/8"
<b>9</b>	01.0201.091	3-5/8"	1-5/8"	7/8"
<b>10</b>	01.0208.071	3"	2"	1"
<b>11</b>	01.0208.041	4-1/8"	2"	1"
<b>12</b>	01.0208.091	4-5/8"	2"	1"

# FRENCH OVERLAY/INSET IRON HINGES

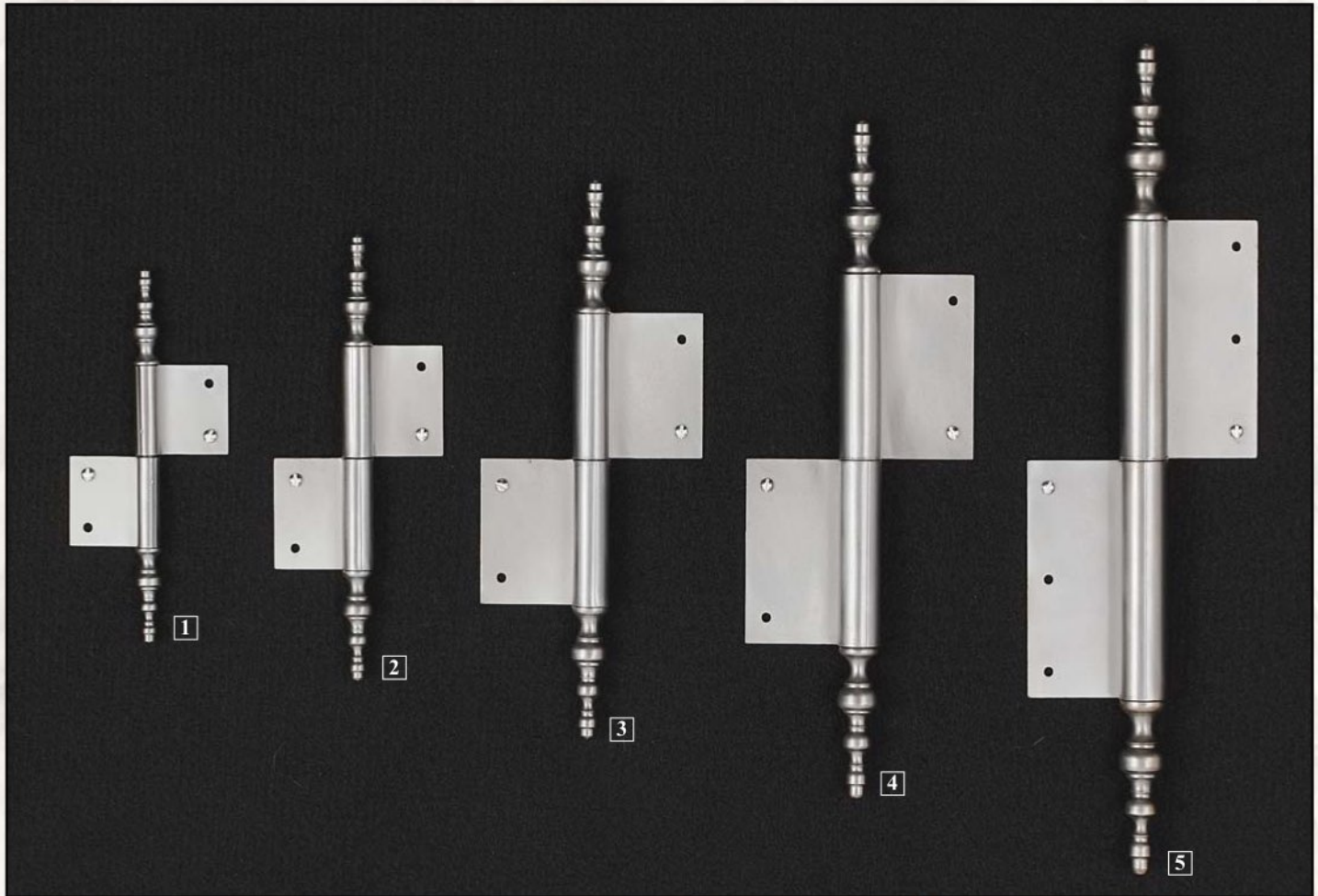

**NOTE:** Hinges on this page are handed. When ordering, please specify handing and application option. Countersinking available to make these hinges non-mortised inset.

**OPTION 1 OVERLAY**      **OPTION 2 OVERLAY**      **OPTION 3 OVERLAY**

**INSET**

IRON	LEFT/RIGHT	A	B	C	D
1	01.2000.141	5-1/2"	1-1/2"	1"	5/16"
2	01.2000.171	6-5/8"	1-3/4"	1"	7/16"
3	01.2000.211	8-1/4"	2-1/4"	1-3/6"	9/16"
4	01.2000.261	10"	2-3/4"	1-3/8"	5/8"
5	01.2000.321	12-1/4"	3-1/2"	1-3/8"	3/4"



# INSET RAT TAIL IRON HINGES

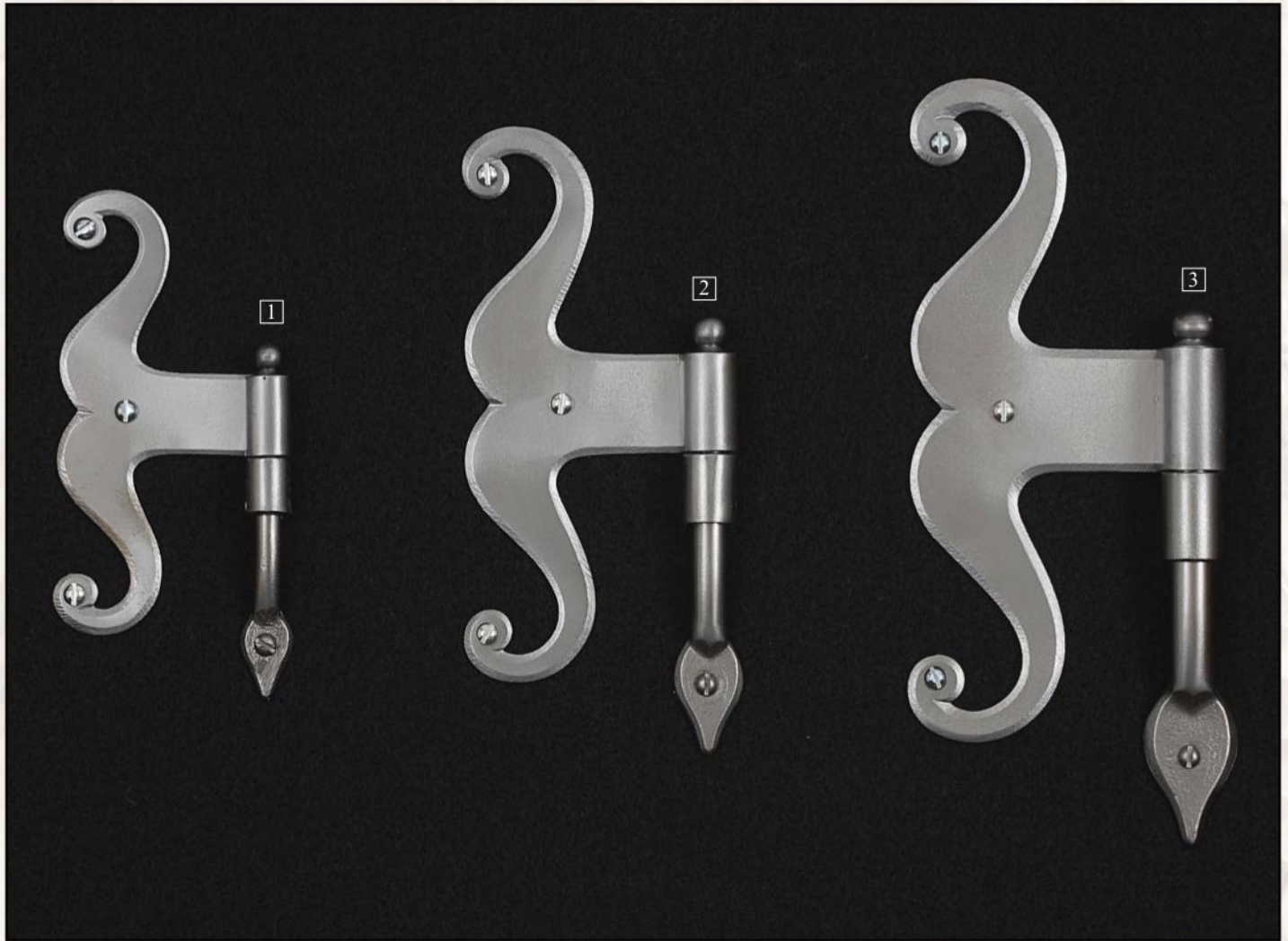

IRON		A	B
<b>1</b>	01.225.101	4"	2-1/8"
<b>2</b>	01.225.121	5"	2-1/2"
<b>3</b>	01.225.151	6"	2-3/4"

# FULL MORTISE IRON INSET HINGES

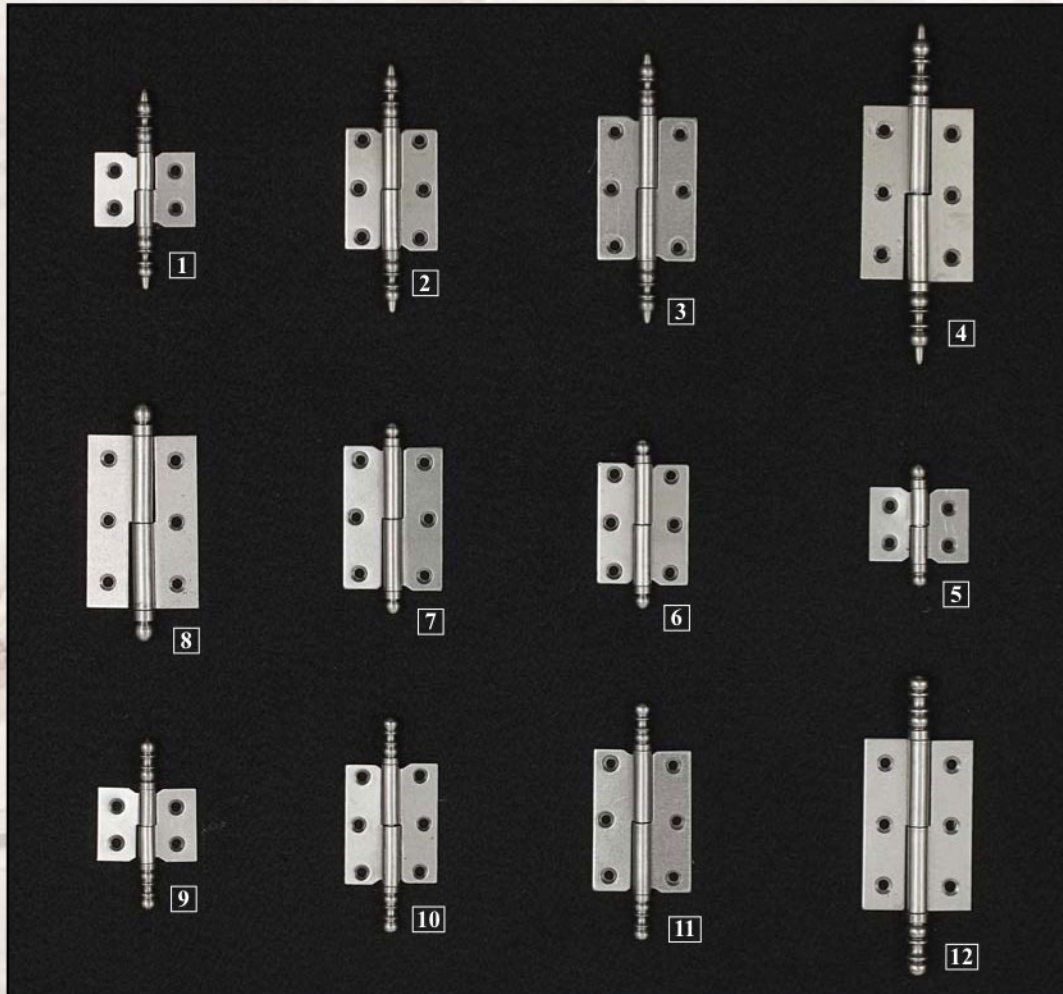

**NOTE:** Hinges on this page are handed, please specify left or right when ordering.

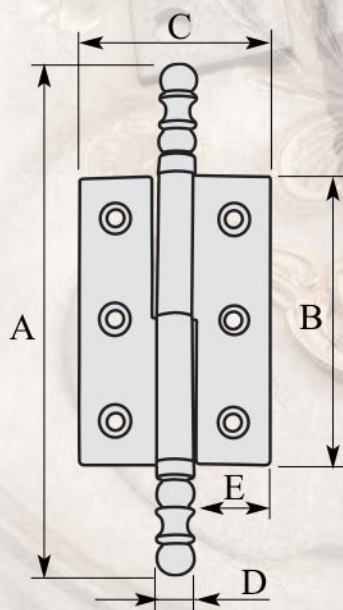

IRON LEFT/RIGHT	A	B	C	D	E
<b>1</b> 01.9.75	3-1/8"	1-3/16"	1-9/16"	5/16"	5/8"
<b>2</b> 01.9.95	4"	1-15/16"	1-1/2"	5/16"	5/8"
<b>3</b> 01.9.105	4-3/8"	2-5/16"	1-9/16"	5/16"	5/8"
<b>4</b> 01.9.135	5-7/16"	2-13/16"	1-3/4"	3/8"	11/16"
<b>5</b> 01.7.71	2"	1-3/16"	1-9/16"	5/16"	5/8"
<b>6</b> 01.7.91	2-3/4"	1-15/16"	1-1/2"	5/16"	5/8"
<b>7</b> 01.7.101	3"	2-5/16"	1-9/16"	5/16"	5/8"
<b>8</b> 01.7.131	3-3/4"	2-13/16"	1-3/4"	3/8"	11/16"
<b>9</b> 01.4.71	2-3/4"	1-3/16"	1-9/16"	5/16"	5/8"
<b>10</b> 01.4.91	3-1/2"	1-15/16"	1-1/2"	5/16"	5/8"
<b>11</b> 01.4.101	3-13/16"	2-5/16"	1-9/16"	5/16"	5/8"
<b>12</b> 01.4.131	5"	2-13/16"	1-3/4"	3/8"	11/16"



# FULL MORTISE IRON BUILDING HINGES

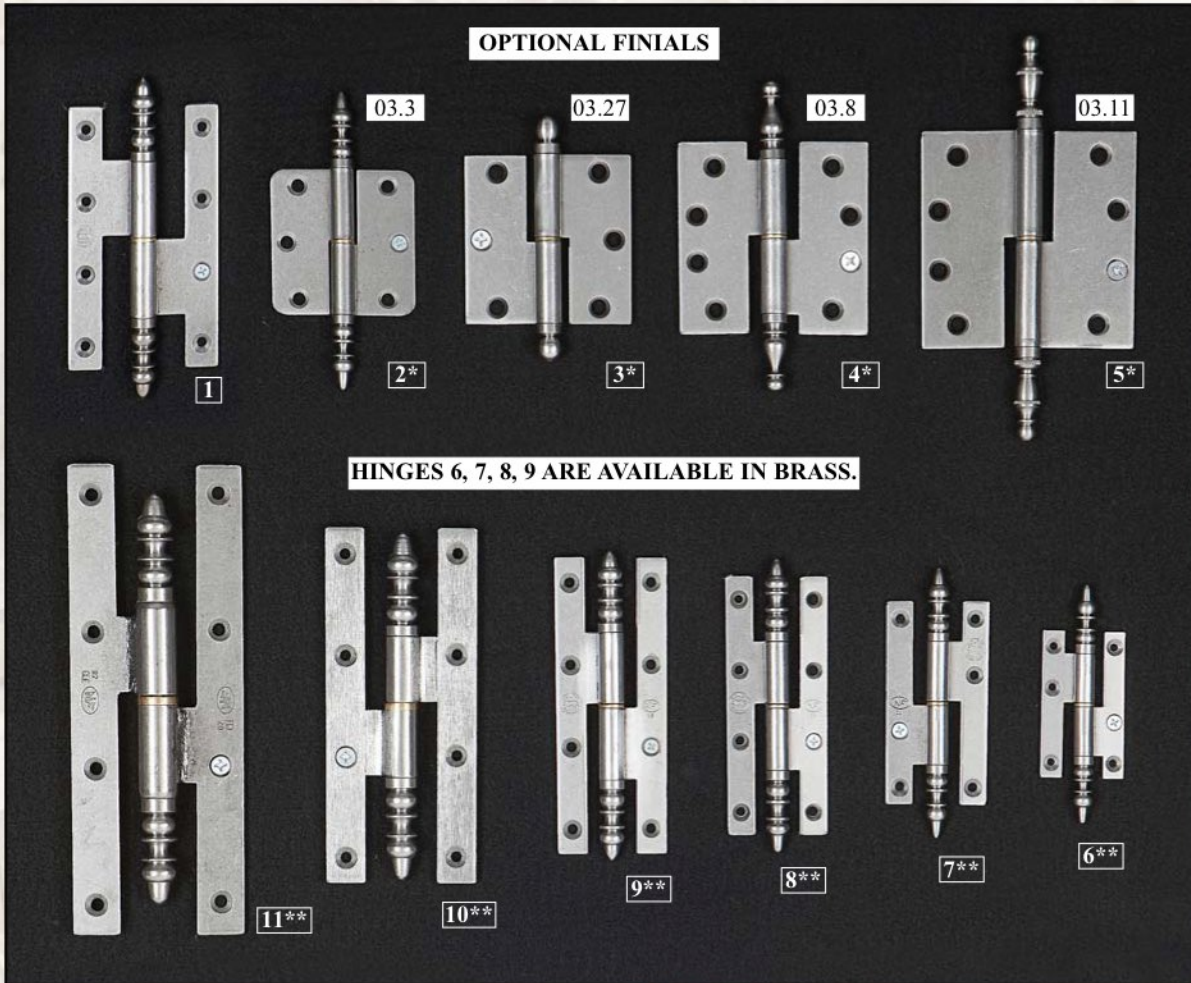

**NOTE:** Hinges on this page are handed, please specify left or right when ordering.

\* All 4 sizes are available with 4 different finial tips.

\*\* Available with ball and standard finial tips only.

"A" measurement is based on our standard finial tip # 03.3.

Please specify finial tip.

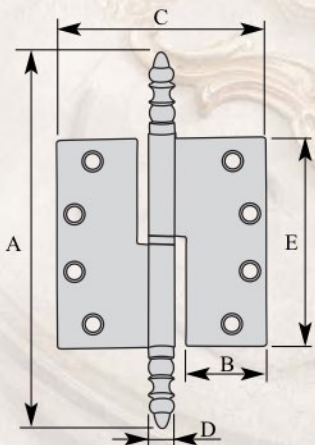

IRON	LEFT/RIGHT	A	B	C	D	E
1	02.0105.141	6-3/4"	11/16"	3-1/8"	9/16"	5-7/16"
2	02.0210.300	6-1/4"	1-1/4"	3"	1/2"	3"
3	02.0210.350	7"	1-5/16"	3-1/2"	9/16"	3-1/2"
4	02.0210.400	6-3/4"	1-7/16"	4"	9/16"	4"
5	02.0210.450	8"	1-3/4"	4-1/2"	9/16"	4-1/2"
6	02.0103.081	5-1/16"	7/16"	1-3/4"	7/16"	3-1/8"
7	02.0103.111	5-3/4"	9/16"	2-3/16"	9/16"	4-5/16"
8	02.0103.141	6-1/4"	9/16"	2-3/16"	9/16"	5-1/2"
9	02.0103.161	6-5/8"	5/8"	2-3/8"	9/16"	6-1/4"
10	02.0059.191	7-1/4"	13/16"	3-1/8"	11/16"	7-7/16"
11	02.0059.251	8-3/4"	1"	3-5/8"	7/8"	9-7/8"

# FULL MORTISE IRON INSET HINGES AND OPTIONAL SLIDE-ON CAPS

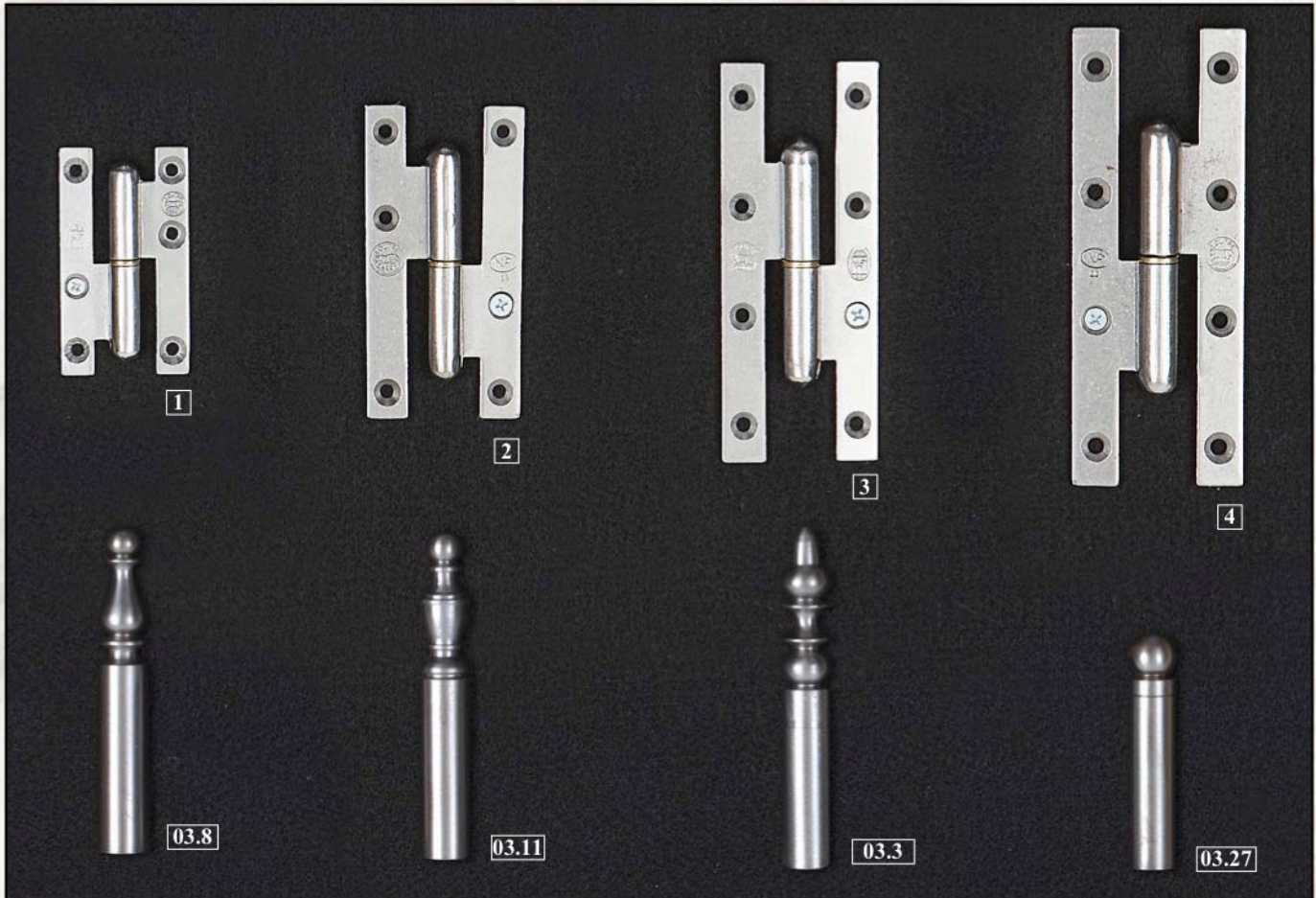

**NOTE:** Hinges on this page are handed, please specify left or right when ordering.  
Caps sold as sets ( 4 caps for 1 pair ).

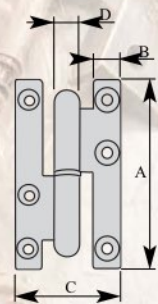
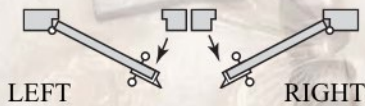

IRON		A	B	C	D	IRON		A	B	C	D
<b>1</b>	02.39.81 L/R	3-1/8"	1/2"	1-3/4"	7/16"	<b>3</b>	02.39.141 L/R	5-1/2"	5/8"	2-3/16"	1/2"
<b>1</b>	with caps 03.3	6-1/4"			1/2"	<b>3</b>	with caps 03.3	7-3/4"			11/16"
<b>1</b>	with caps 03.8	6-1/4"			1/2"	<b>3</b>	with caps 03.8	7-3/4"			11/16"
<b>1</b>	with caps 03.11	6"			1/2"	<b>3</b>	with caps 03.11	7-1/2"			11/16"
<b>1</b>	with caps 03.27	4-1/2"			1/2"	<b>3</b>	with caps 03.27	5-1/4"			11/16"
<b>2</b>	02.39.111 L/R	4-5/16"	9/16"	2-1/8"	1/2"	<b>4</b>	02.39.161 L/R	6-5/16"	5/8"	2-3/16"	9/16"
<b>2</b>	with caps 03.3	7-1/4"			9/16"	<b>4</b>	with caps 03.3	8-1/4"			11/16"
<b>2</b>	with caps 03.8	7-1/4"			9/16"	<b>4</b>	with caps 03.8	8-1/4"			11/16"
<b>2</b>	with caps 03.11	7"			9/16"	<b>4</b>	with caps 03.11	8-1/4"			11/16"
<b>2</b>	with caps 03.27	5-3/4"			9/16"	<b>4</b>	with caps 03.27	6"			11/16"



# IRON STRAP HINGES

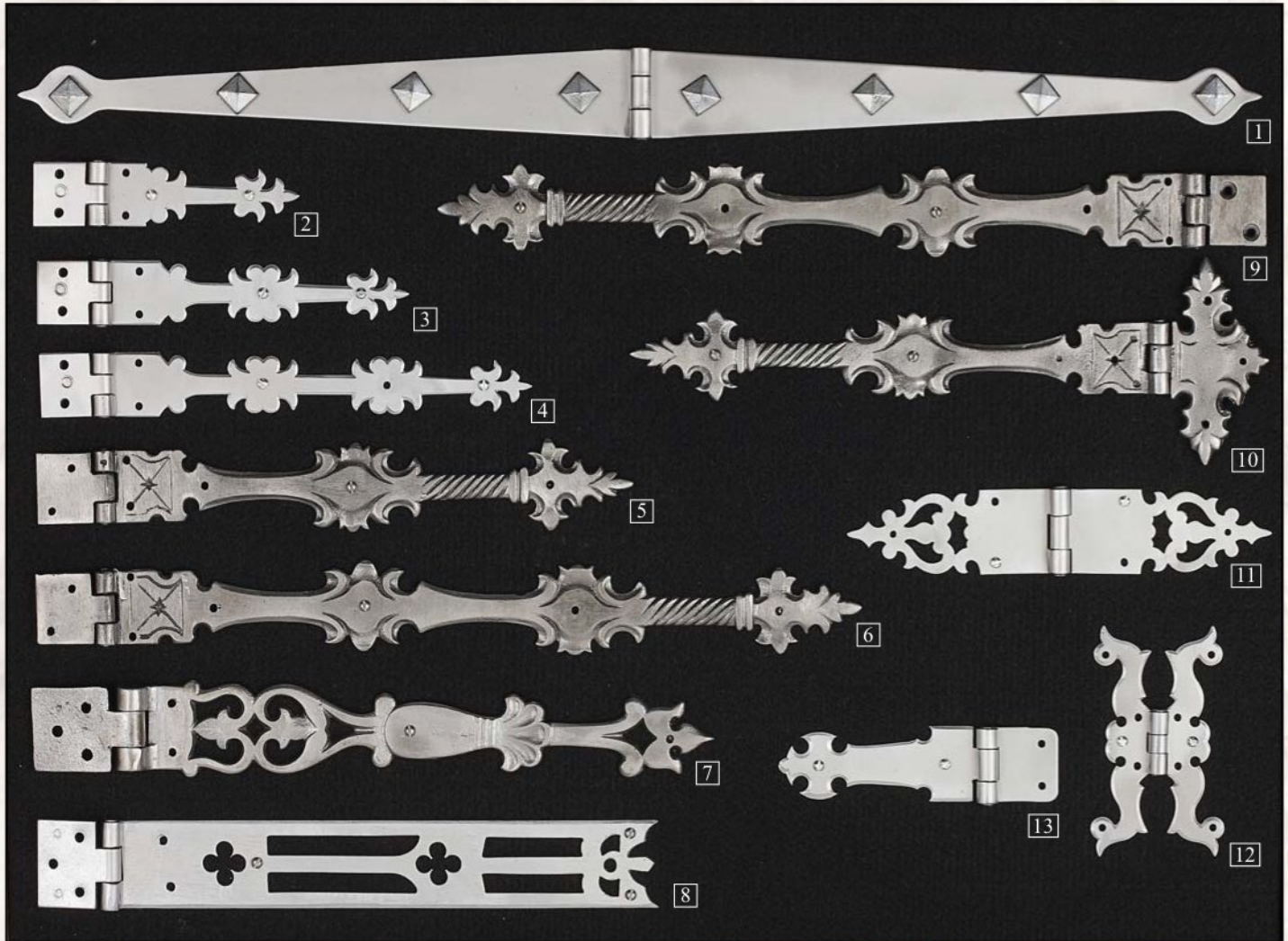

**NOTE:** "A" measurement on mortise hinges starts at the knuckle.

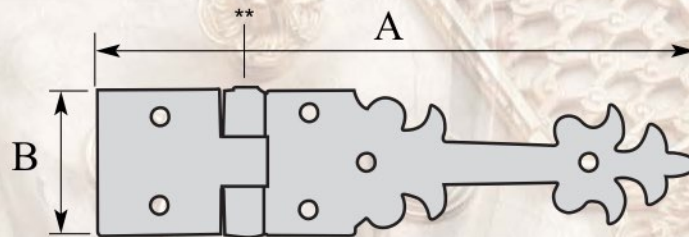

IRON		A	B
<b>1</b>	16.9812.0001	24"	1-3/4"
<b>2</b>	** 16.2013.101	3-9/16"	1-1/4"
<b>3</b>	** 16.2013.151	5-9/16"	1-3/16"
<b>4</b>	** 16.2013.0201	7-3/4"	1-3/16"
<b>5</b>	** 16.1507.255	9-3/4"	1-3/8"
<b>6</b>	** 16.1507.350	14"	1-3/8"
<b>7</b>	** 16.1537	11"	1-1/2"

IRON		A	B
<b>8</b>	** 16.9813.0001	12"	1-3/4"
<b>9</b>	16.1507.351	15"	3-3/4"
<b>10</b>	16.1507.251	11-3/4"	3-7/8"
<b>11</b>	16.5273.1	3-3/4"	1-9/16"
<b>12</b>	* 16.5300.1	4-5/16"	1-1/8"
<b>13</b>	** 16.5245.1	1-3/8"	3-9/16"

\* Available in brass  
\*\* Mortise

# BRASS / IRON FURNITURE LOCKS



Keys are sold separately,  
see pages 25 and 28

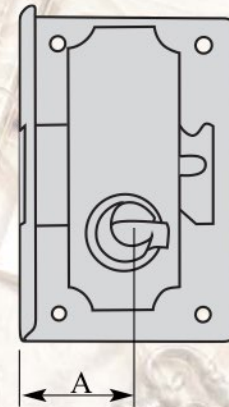
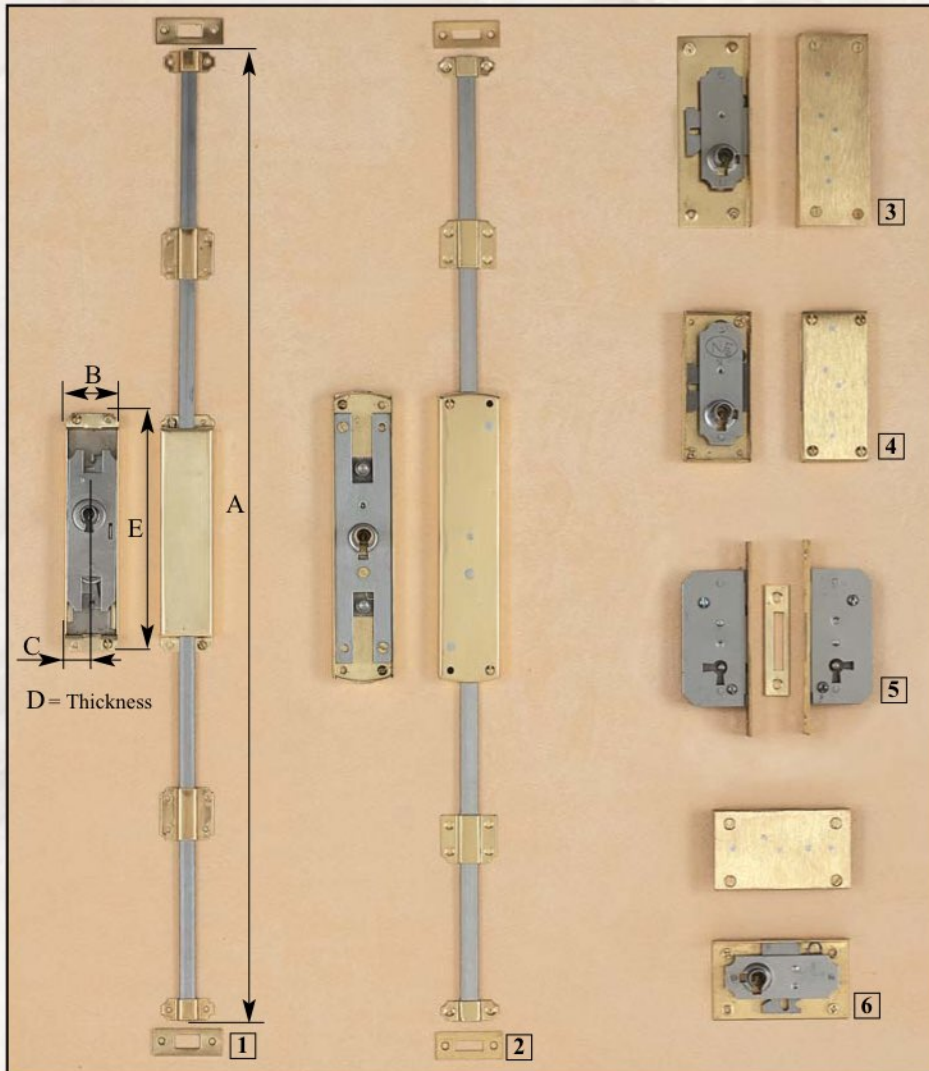

**NOTE:**  
Lock # 6 is for drawers and right hand doors only.  
Locks # 3, 4 and 5 work for drawer, left hand and right hand doors.  
Please specify lock position when ordering.

BRASS / IRON	A	B	C	D	E
** <b>1</b> *04.0235.0001	78"	1-1/8"	9/16"	7/16"	4-1/4"
<b>1</b> *04.0235.0002	78"	1-1/8"	9/16"	7/16"	4-1/4"
<b>2</b> *04.0646.0002	78"	1-1/4"	5/8"	7/16"	5-7/8"

\* Shipped with two 1 meter rods (approx. 39-1/2") each.

\*\* Iron lock not shown.

BRASS	LEFT/RIGHT	Backset	BRASS	LEFT/RIGHT	Backset
<b>3</b>	04.514.152L/R	9/16"	<b>4</b>	04.528.302L/R	1-3/16"
<b>3</b>	04.514.202L/R	3/4"	<b>4</b>	04.528.352L/R	1-3/8"
<b>3</b>	04.514.252L/R	1"	<b>4</b>	04.528.402L/R	1 1/2"
<b>3</b>	04.514.302L/R	1-3/16"	<b>5</b>	04.518.152L/R	9/16"
<b>3</b>	04.514.352L/R	1-3/8"	<b>5</b>	04.518.202L/R	3/4"
<b>3</b>	04.514.402L/R	1-1/2"	<b>5</b>	04.518.252L/R	1"
<b>4</b>	04.528.152L/R	9/16"	<b>5</b>	04.518.302L/R	1-3/16"
<b>4</b>	04.528.202L/R	3/4"	<b>5</b>	04.518.352L/R	1-3/8"
<b>4</b>	04.528.252L/R	1"	<b>5</b>	04.518.402L/R	1-1/2"

BRASS	RIGHT/DRAWER	Backset
<b>6</b>	04.267.202R/D	3/4"
<b>6</b>	04.267.252R/D	1"
<b>6</b>	04.267.302R/D	1-3/16"
<b>6</b>	04.267.352R/D	1-3/8"
<b>6</b>	04.267.402R/D	1-1/2"
<b>6</b>	04.267.452R/D	1-3/4"
<b>6</b>	04.267.502R/D	2"
<b>6</b>	04.267.552R/D	2-1/8"
<b>6</b>	04.267.602R/D	2-3/8"
<b>6</b>	04.267.652R/D	2-1/2"
<b>6</b>	04.267.702R/D	2-3/4"
<b>6</b>	04.267.752R/D	2-15/16"
<b>6</b>	04.267.802R/D	3-1/8"
<b>6</b>	04.267.852R/D	3-3/8"
<b>6</b>	04.267.902R/D	3-9/16"
<b>6</b>	04.267.1002R/D	3-7/8"



# IRON FURNITURE LOCKS

Keys are sold separately,  
see pages 25 and 28

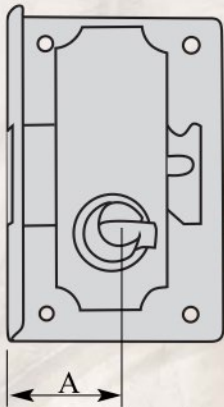

**NOTE:**  
Lock # 3 is for drawers and right hand doors only.  
Lock # 2 works for drawers, left hand and right hand doors.  
Please specify lock position when ordering.

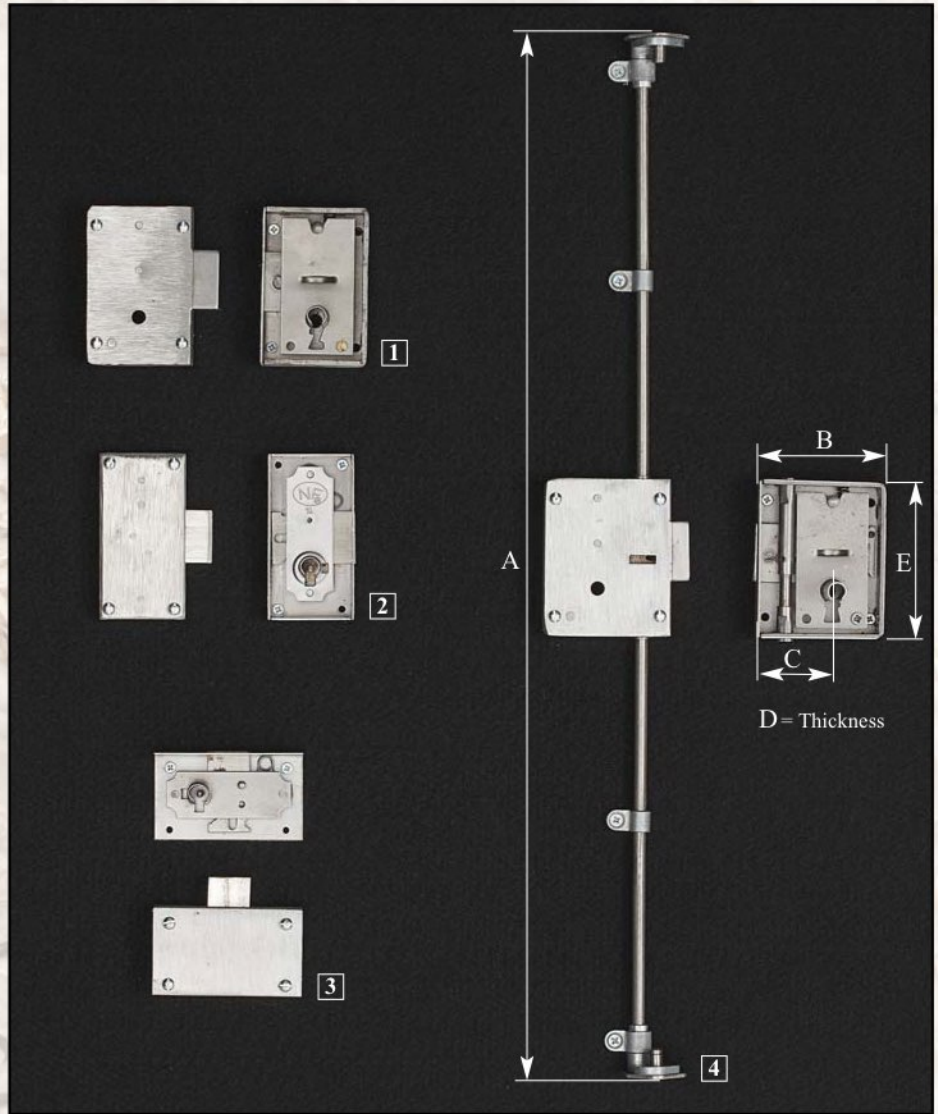

**NOTE:** Complete lock dimensions are available upon request.

IRON	LEFT/RIGHT	Backset
1	04.305.251	1"
1	04.305.301	1-3/16"
1	04.305.351	1-3/8"
1	04.305.401	1-1/2"
1	04.305.451	1-3/4"
1	04.305.501	2"
1	04.305.551	2-1/8"
1	04.305.601	2-3/8"
2	04.526.151	9/16"
2	04.526.201	3/4"
2	04.526.251	1"
2	04.526.301	1-3/16"
2	04.526.351	1-3/8"
2	04.526.401	1-1/2"

IRON	RIGHT/DRAWER	Backset
3	04.267.201	3/4"
3	04.267.251	1"
3	04.267.301	1-3/16"
3	04.267.351	1-3/8"
3	04.267.401	1-1/2"
3	04.267.451	1-3/4"
3	04.267.501	2"
3	04.267.551	2-1/8"
3	04.267.601	2-3/8"

IRON	LEFT/RIGHT	A	B	C	D	E
4	*04.306.251	81"	2-3/8"	1"	11/16"	
4	*04.306.301	81"	2-3/16"	1-3/16"	11/16"	
4	*04.306.351	81"	2-3/8"	1-3/8"	11/16"	

\*Shipped with two 1 meter rods (approx. 39-1/2") each.

# BRASS KEYS

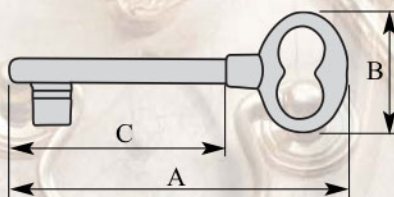

BRASS	A	B	C	
<b>1</b>	10.0941.0002	3-1/4"	1-1/2"	1-1/2"
<b>2</b>	10.4460.302	2-9/16"	1-1/4"	1-3/16"
<b>2</b>	10.4460.402	3-1/16"	1-1/4"	1-9/16"
<b>2</b>	10.4460.452	3-1/4"	1-1/4"	1-3/4"
<b>2</b>	10.4460.0602	3-7/8"	1-1/4"	2-3/8"
<b>3</b>	10.5221.0402	3"	7/8"	1-1/2"
<b>4</b>	10.0090.0002	3"	7/8"	1-9/16"

BRASS	A	B	C	
<b>5</b>	10.5481.302	2-3/8"	1-3/16"	1-3/16"
<b>5</b>	10.5481.402	2-3/4"	1-1/16"	1-1/2"
<b>6</b>	10.4431.2	3-7/16"	1-9/16"	15/16"
<b>7</b>	10.3804.2	2-7/8"	3/4"	1-1/2"
<b>8</b>	10.3916.2	3-1/8"	1-3/8"	1-1/2"
<b>9</b>	10.3899.2	3-1/4"	1-3/16"	1-9/16"
<b>10</b>	10.3931.2	3"	1-1/8"	1-9/16"



# BRASS FALSE KEYS

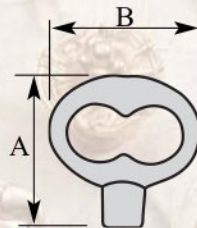

**BRASS**

		<b>A</b>	<b>B</b>
<b>1</b>	14.3890	1-11/16"	1-3/16"
<b>2</b>	14.3894	1-13/16"	1-1/4"
<b>3</b>	14.3893	2"	1-1/4"
<b>4</b>	14.3891	1-5/8"	7/8"
<b>5</b>	14.3921.22	1-1/2"	7/8"
<b>6</b>	14.3930.2	1-7/16"	1-1/16"
<b>7</b>	14.325.2	1-11/16"	1-1/8"
<b>8</b>	14.0043.0002	1-3/4"	1-1/8"
<b>9</b>	14.4431.32	1-7/8"	1-1/4"
<b>10</b>	14.4431.22	1-5/8"	1"

**BRASS**

		<b>A</b>	<b>B</b>
<b>11</b>	14.5221.0002	1-3/8"	7/8"
<b>12</b>	14.814.2	1-7/8"	1-1/4"
<b>13</b>	14.0054.0002	1-3/16"	1-3/16"
<b>14</b>	14.1545.2	1-5/16"	7/8"
<b>15</b>	14.1014.2	1-5/8"	1-5/16"
<b>16</b>	14.3940.2	1-1/2"	1-1/8"
<b>17</b>	14.0090.0002	1-1/2"	7/8"
<b>18</b>	14.5461	1-11/16"	1-1/8"
<b>19</b>	14.4422.2	1-7/16"	1"

# BRASS FALSE KEYS

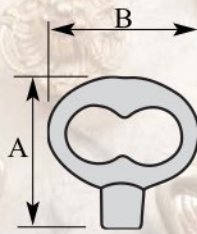
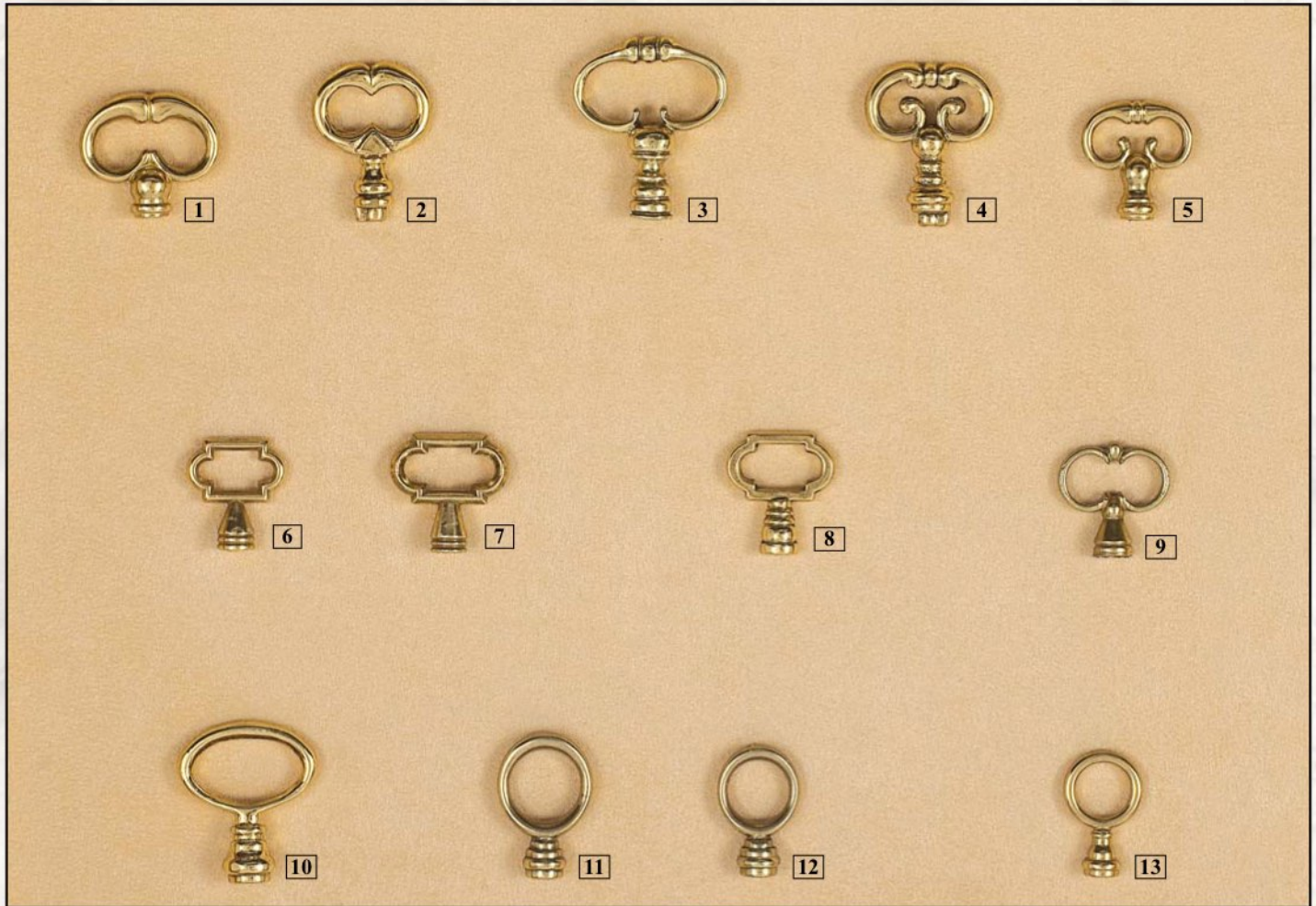

BRASS		A	B
<b>1</b>	14.4465.35	1-1/4"	1-3/8"
<b>2</b>	14.4465.282	1-9/16"	1-1/4"
<b>3</b>	14.0941.0002	1-3/4"	1-1/2"
<b>4</b>	14.4461.282	1-5/8"	1-5/16"
<b>5</b>	14.4463.2	1-3/16"	1-1/8"
<b>6</b>	14.5481.22	1-1/8"	1"
<b>7</b>	14.5481.32	1-3/16"	1-3/16"

BRASS		A	B
<b>8</b>	14.5482.32	1-1/4"	1-1/16"
<b>9</b>	14.3918.2	1-1/8"	1-1/8"
<b>10</b>	14.3916	1-5/8"	1-7/16"
<b>11</b>	14.3917.35	1-1/2"	15/16"
<b>12</b>	14.3917	1-5/16"	7/8"
<b>13</b>	14.3803.2	1-5/16"	3/4"



# IRON KEYS AND FALSE KEYS

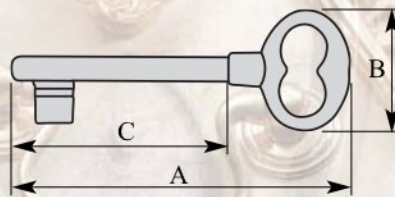

\*\* For lock 04.305 only

IRON		A	B	C
<b>1</b>	**10.305.1	3-7/16"	1-1/4"	2-1/4"
<b>2</b>	10.4460.351	2-3/4"	1-1/4"	1-3/8"
<b>2</b>	10.4460.401	3"	1-3/16"	1-1/2"
<b>2</b>	10.4460.0601	3-5/8"	1-1/4"	2-1/4"
<b>3</b>	10.4465.401	2-3/16"	1-5/16"	1-5/8"
<b>4</b>	10.4464.31	2-5/16"	1"	1-3/16"

IRON		A	B	C
<b>4</b>	10.4464.41	2-7/8"	1"	1-3/16"
<b>5</b>	14.1519.1	1-11/16"		1-1/4"
<b>6</b>	14.4461.181	1-9/16"		1-1/4"
<b>7</b>	14.4465.181	1-1/2"		1-5/16"
<b>8</b>	14.1598.1	1-9/16"		1-3/16"

# IRON PULLS

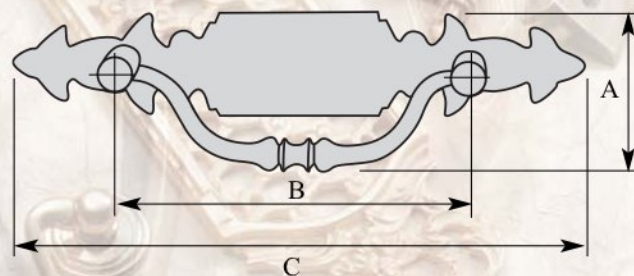
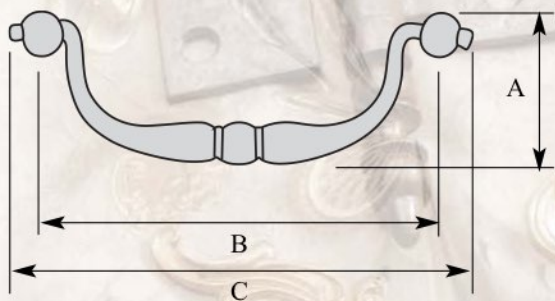
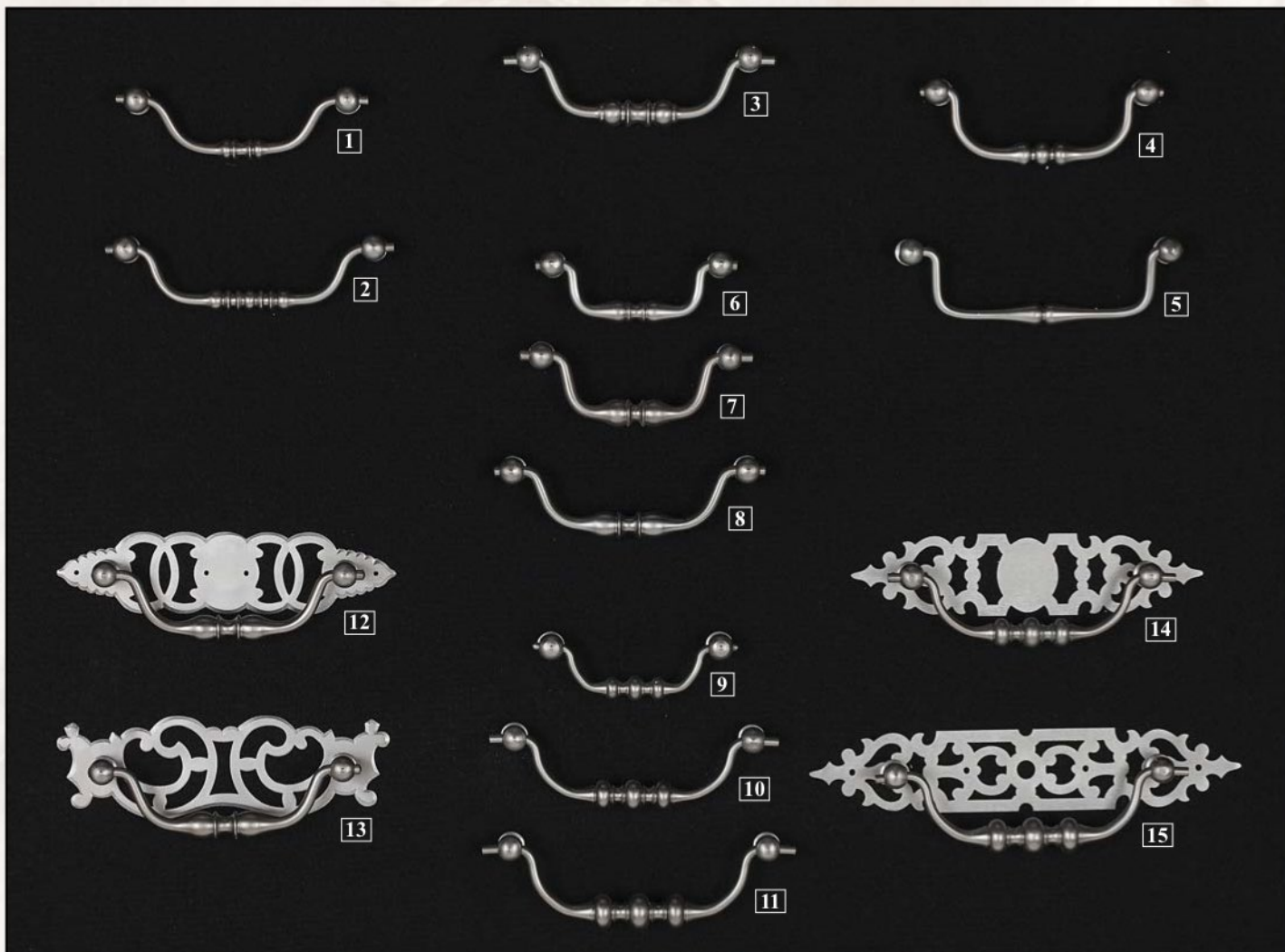

IRON		A	B	C
<b>1</b>	05.1256.1251	1-3/8"	4-1/8"	4-3/4"
<b>2</b>	05.1256.1401	1-9/16"	4-7/8"	5-1/2"
<b>3</b>	05.2020.1151	1-1/2"	4-1/2"	5-1/8"
<b>4</b>	05.1554.1	1-5/8"	4"	4-1/2"
<b>5</b>	05.1502.1201	1-9/16"	4-3/4"	5-1/4"
<b>6</b>	05.21.85.1	1-1/4"	3-3/8"	3-15/16"
<b>7</b>	05.21.95.1	1-1/2"	4"	4-1/2"
<b>8</b>	05.21.115.1	1-5/8"	4-1/4"	5-1/8"

IRON		A	B	C
<b>9</b>	05.900.1	1-1/4"	3-1/2"	4"
<b>10</b>	05.1279.1	1-5/8"	4-5/8"	5-1/4"
<b>11</b>	05.1279.141	2"	5-3/8"	5-7/8"
<b>12</b>	05.0020.00K1	2-5/16"	4-1/2"	6-7/16"
<b>13</b>	05.0019.00K1	2-1/2"	4-1/2"	6-5/16"
<b>14</b>	05.1280.00K1	2-1/4"	4-5/8"	6-13/16"
<b>15</b>	05.1280.14K1	3-1/2"	5-1/8"	8-5/16"

# IRON PULLS

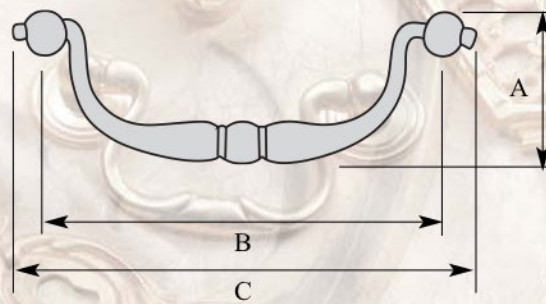
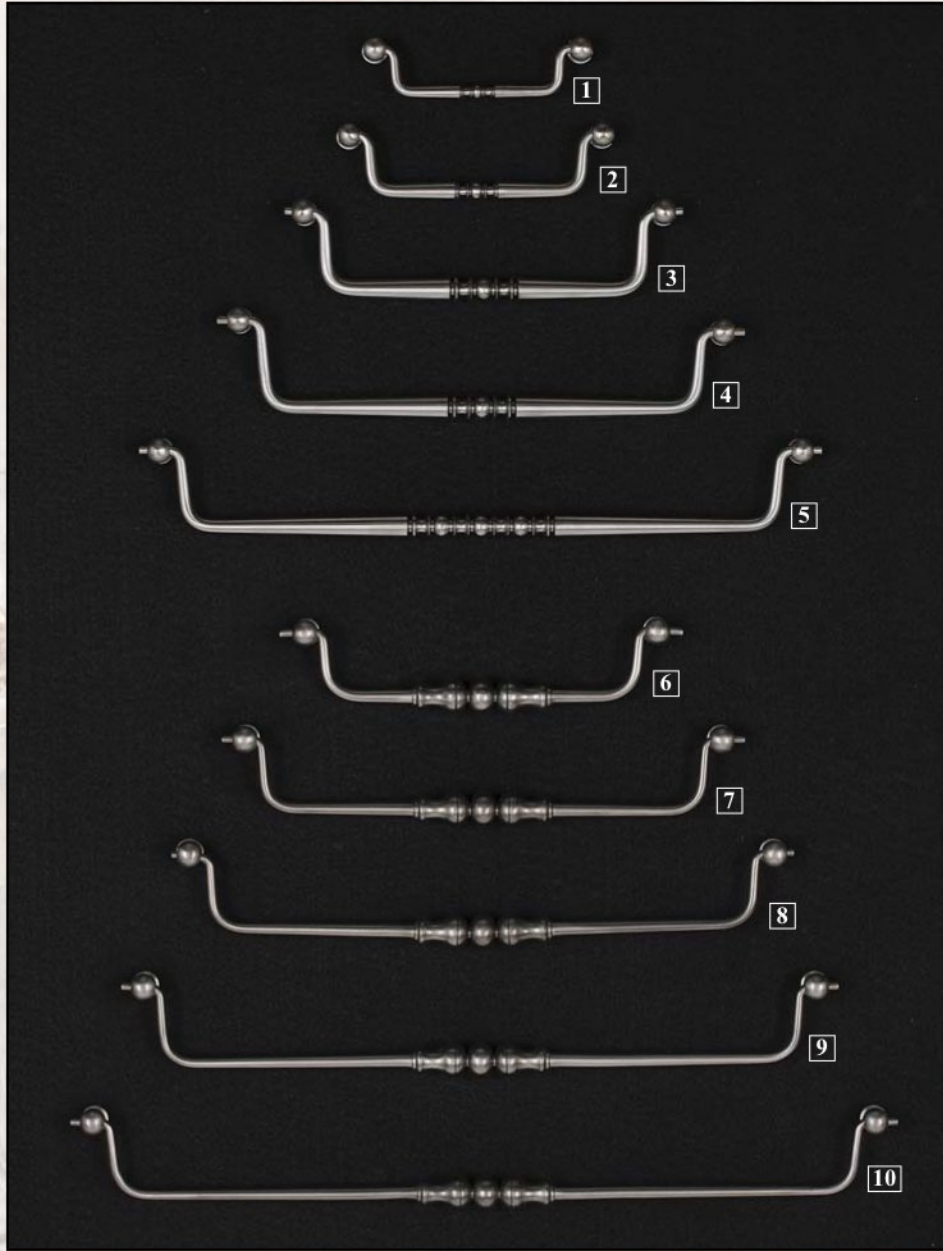

IRON		A	B	C
<b>1</b>	05.2025.1001	1-1/2"	4"	4-1/2"
<b>2</b>	05.2025.1301	1-5/8"	5-1/8"	5-5/8"
<b>3</b>	05.2025.1901	2"	7-1/2"	8-1/4"
<b>4</b>	05.2025.2501	2"	9-7/8"	10-5/8"
<b>5</b>	05.2025.3401	2"	13-3/8"	14-1/8"

IRON		A	B	C
<b>6</b>	05.6383.181	2-1/16"	7-3/16"	7-13/16"
<b>7</b>	05.6383.251	2-1/16"	10-1/8"	10-7/8"
<b>8</b>	05.6383.301	2-1/16"	12"	12-9/16"
<b>9</b>	05.6383.351	2-1/16"	13-3/4"	14-1/2"
<b>10</b>	05.6383.401	2-1/16"	16"	16-11/16"

# IRON PULLS



# IRON PULLS

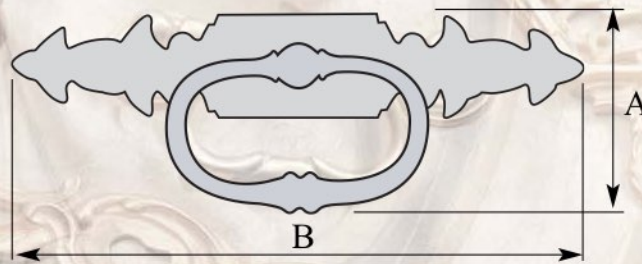
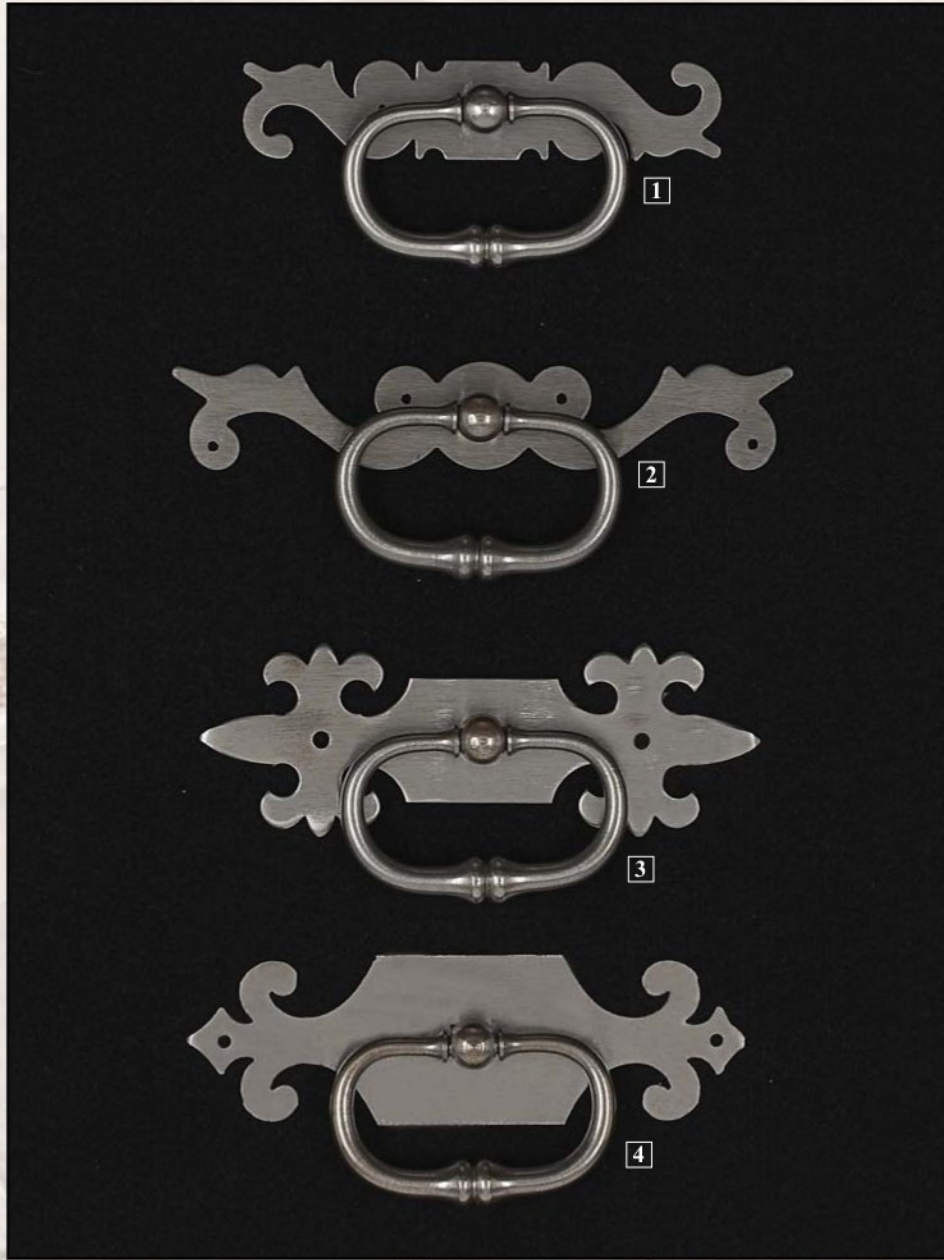

IRON		A	B
<b>1</b>	05.0603.00K1	2"	4-1/2"
<b>2</b>	05.0606.00K1	2-1/8"	6"
<b>3</b>	05.3139.00K1	2-7/16"	5-1/2"
<b>4</b>	05.3140.00K1	2-3/8"	5-3/8"

# IRON PULLS

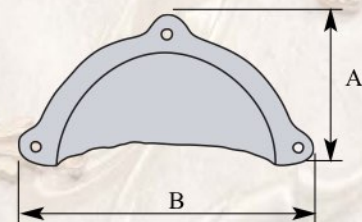
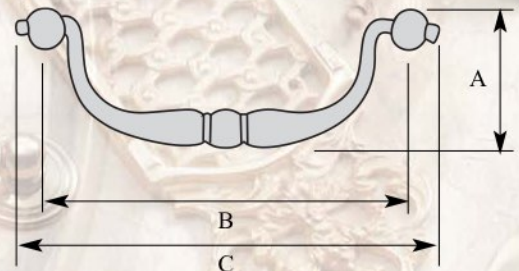
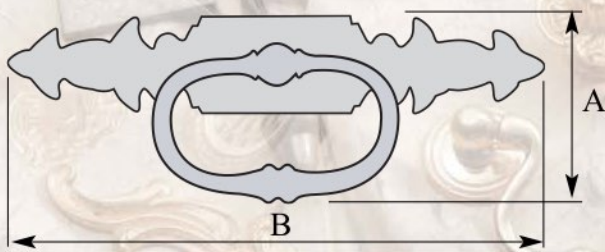
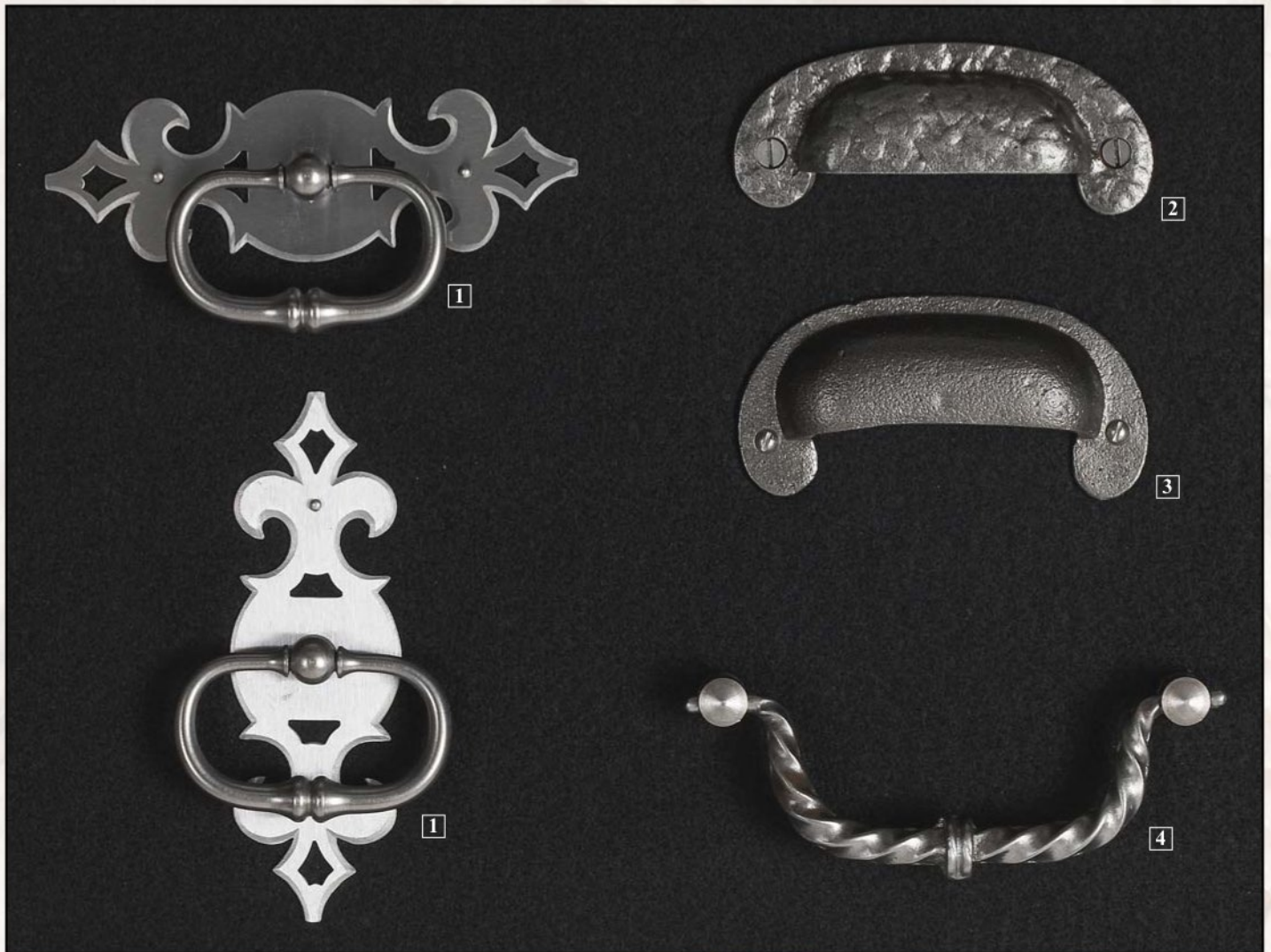

IRON		A	B	C
<b>1</b>	05.5166.00K1	2-3/4"	5-3/4"	
<b>2</b>	05.265.1	1-3/4"	4-1/4"	
<b>3</b>	05.0266.0001	2"	4"	
<b>4</b>	05.1482.1	2-1/8"	4-1/2"	5-1/4"

# IRON PULLS

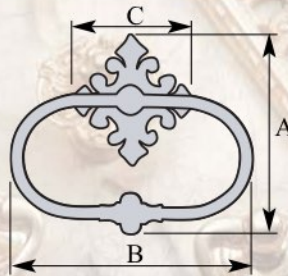

IRON		A	B	C
<b>1</b>	05.39.31	1-5/8"	1-3/16"	1-1/16"
<b>2</b>	05.39.41	2"	1-1/2"	1-1/16"
<b>3</b>	05.39.51	2-1/4"	1-13/16"	1-1/16"
<b>4</b>	05.39.61	2-5/8"	2-3/16"	1-1/16"
<b>5</b>	05.51.451	1-11/16"	1-13/16"	1-1/16"
<b>6</b>	05.51.521	1-15/16"	2-1/16"	1-1/16"
<b>7</b>	05.51.651	2-3/8"	2-11/16"	1-1/16"
<b>8</b>	05.51.801	2-5/8"	3-1/4"	1-1/16"
<b>9</b>	05.40.31	1-1/2"	1-1/4"	13/16"
<b>10</b>	05.40.41	2-1/8"	1-5/8"	1"

IRON		A	B	C
<b>11</b>	05.40.51	2-1/2"	2"	1"
<b>12</b>	05.40.61	2-7/8"	2-3/8"	1-3/16"
<b>13</b>	05.45.41	2"	1-5/8"	1"
<b>14</b>	05.45.51	2-1/2"	2"	1-13/16"
<b>15</b>	05.0116.0501	2-3/8"	2"	15/16"
<b>16</b>	05.0116.0401	2"	1-5/8"	15/16"
<b>17</b>	05.8040.1	3-3/8"	4-7/16"	2-1/2"
<b>18</b>	05.223.1	2-1/8"	2-3/4"	15/16"
<b>19</b>	05.8030.1	3-3/4"	4-1/2"	1-3/4"

# IRON PULLS

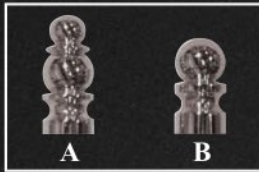

OPTIONAL FINIALS

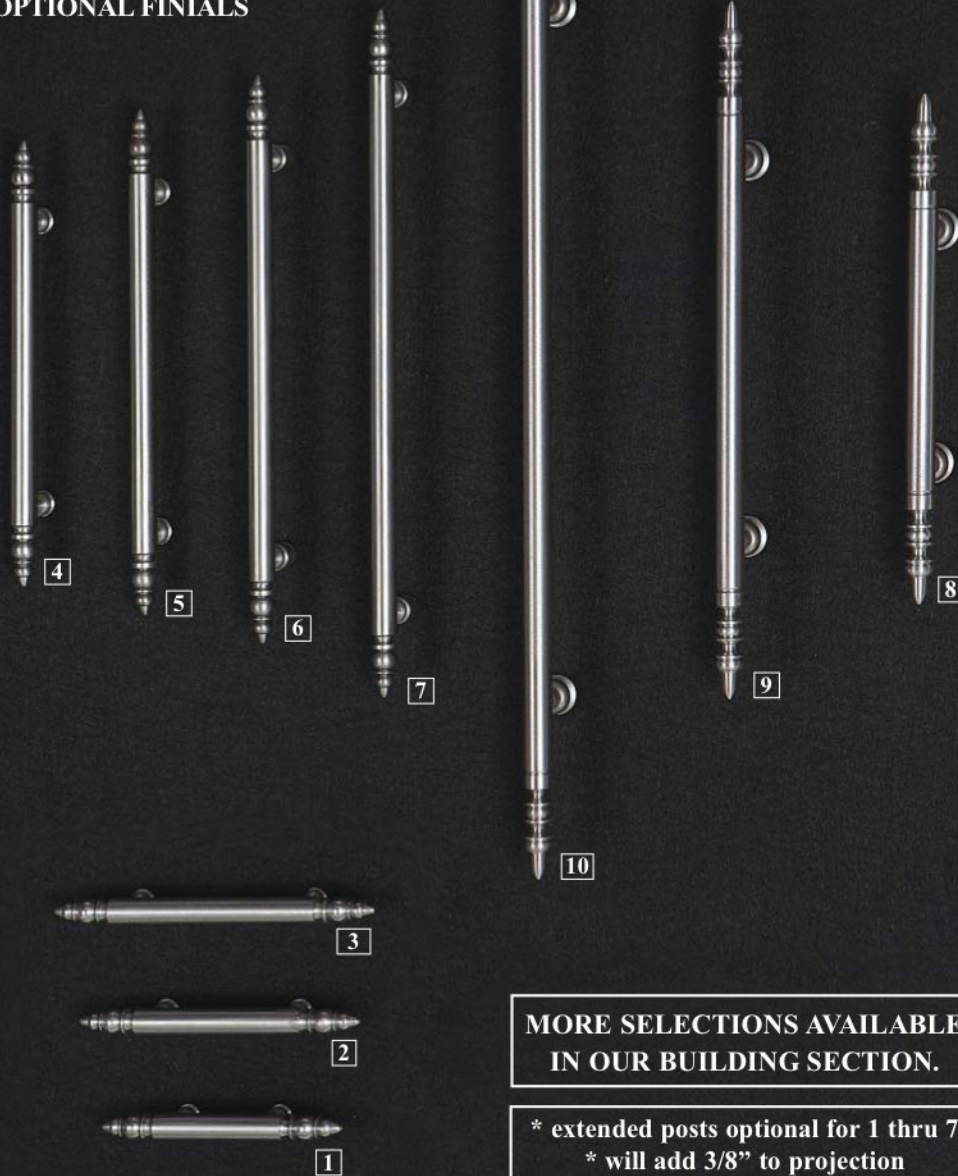

MORE SELECTIONS AVAILABLE  
IN OUR BUILDING SECTION.

\* extended posts optional for 1 thru 7  
\* will add 3/8" to projection

NOTE: For an added touch see rosettes page 83.

IRON		A	B	C	D	IRON	A	B	C	D	
<b>1</b>	05.41.1201	4-5/8"	1-3/4"	1/2"	1-1/16"	<b>6</b>	05.41.2501	10"	7-1/8"	1/2"	1-1/16"
<b>2</b>	05.41.1401	5-3/8"	2-5/8"	1/2"	1-1/16"	<b>7</b>	05.41.3001	12"	9-1/8"	1/2"	1-1/16"
<b>3</b>	05.41.1601	6-3/16"	3-3/8"	1/2"	1-1/16"	<b>8</b>	19.0005.0201	8-1/2"	4"	1/2"	1-5/8"
<b>4</b>	05.41.2001	8"	5-1/8"	1/2"	1-1/16"	<b>9</b>	19.0005.0301	11-3/4"	6-1/2"	1/2"	1-5/8"
<b>5</b>	05.41.2301	9"	6-1/8"	1/2"	1-1/16"	<b>10</b>	19.0005.0451	18-1/8"	12"	1/2"	1-5/8"
						<b>NOT SHOWN</b>	19.0005.0601	19-1/4"	13-3/4"	1/2"	1-5/8"



# IRON PULLS COLLECTION

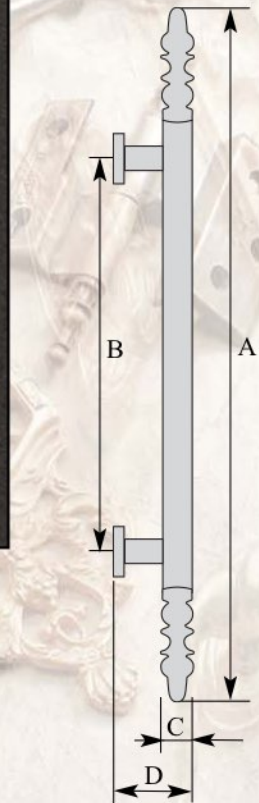

IRON		A	B	C	D
<b>1</b>	05.68.101	4-3/8"	3-3/4"	5/8"	1-5/8"
<b>2</b>	05.68.121	5-1/2"	5"	5/8"	1-5/8"
<b>3</b>	05.68.161	6-3/4"	6-5/16"	5/8"	1-5/8"
<b>4</b>	19.68.201	8-3/4"	8"	7/8"	2-3/8"
<b>5</b>	19.68.301	12-3/4"	12"	7/8"	2-3/8"
<b>6</b>	19.68.401	16-3/4"	16"	7/8"	2-3/8"

# LARGE IRON PULLS

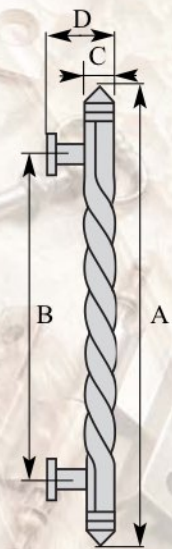

NOTE: Item # 5 is available up to 39-1/2" (1 meter).

IRON		A	B	C	D
<b>1</b>	05.1556.161	10-7/8"	8-3/4"	1-1/16"	2-5/16"
<b>2</b>	19.1380.0331	13"	10-7/8"	3/4"	2-7/8"
<b>3</b>	19.0009.0301	12"	5-9/16"	11/16"	2-1/4"
<b>4</b>	19.0009.0401	16"	7-3/16"	11/16"	2-1/4"
<b>5</b>	19.0009.0501	20"	11-1/8"	11/16"	2-1/4"
<b>NOT SHOWN</b>	19.0009.1001	40"	30-1/4"	11/16"	2-1/4"
<b>6</b>	19.1379.251	9-7/8"	6"	9/16"	2-11/16"
<b>7</b>	19.1379.301	11-5/8"	7-15/16"	5/8"	3"
<b>8</b>	19.1379.351	13-13/16"	9-7/8"	5/8"	3"
<b>9</b>	19.1379.401	15-1/2"	11-13/16"	11/16"	2-5/8"
<b>10</b>	19.1379.451	17-9/16"	16-5/8"	3/4"	3"

# IRON PULLS

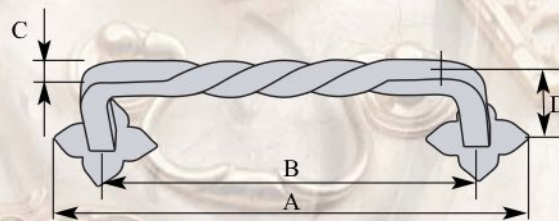
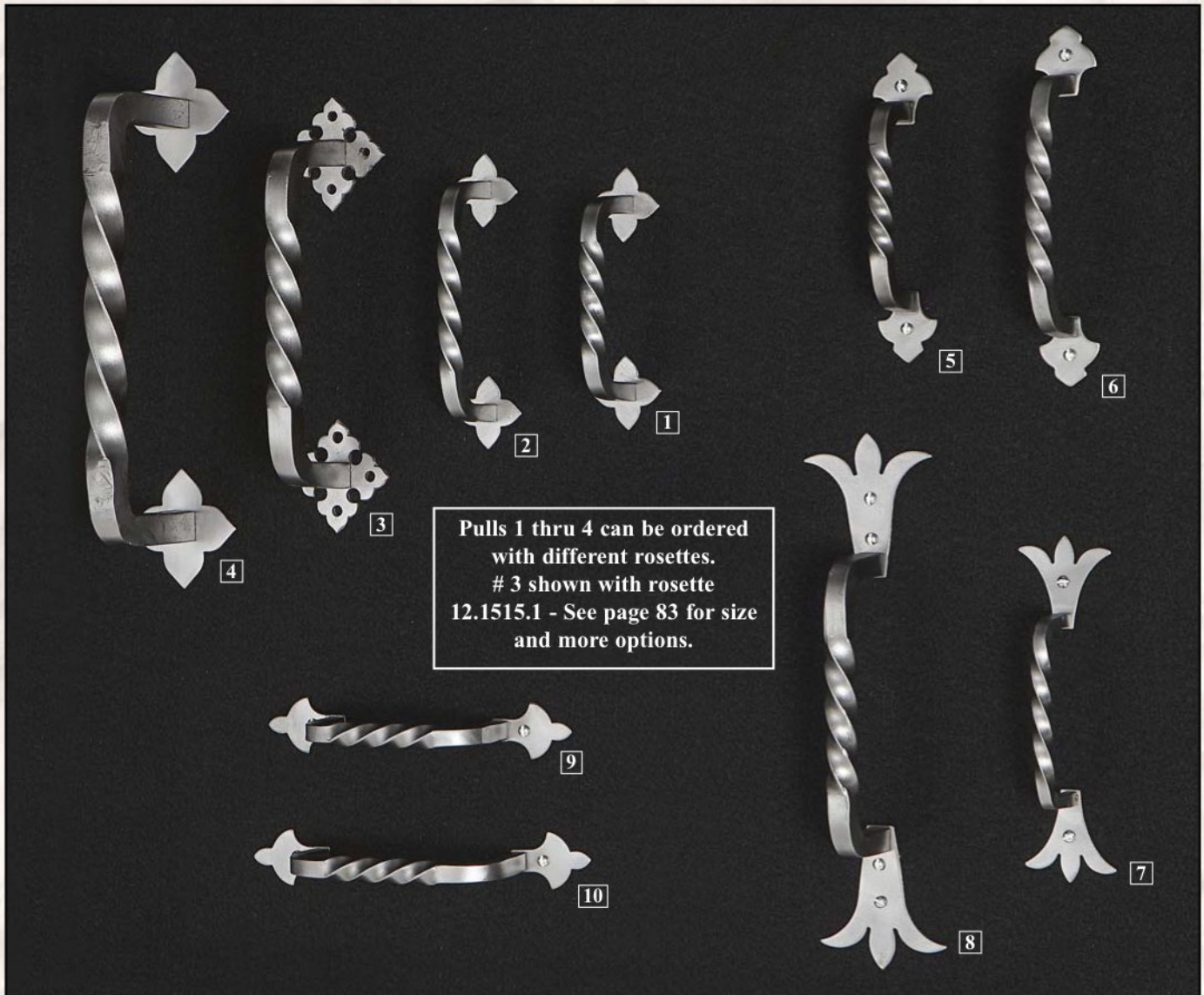

IRON		A	B	C	D	IRON		A	B	C	D
<b>1</b>	05.362.81	4-3/16"	3-1/8"	3/8"	1-3/8"	<b>6</b>	05.262.151	5-15/16"		7/16"	1-5/16"
<b>2</b>	05.362.101	5"	3-7/8"	3/8"	1-1/2"	<b>7</b>	05.5248.1501	5-3/4"		1-5/8"	1-3/8"
<b>3</b>	05.362.151	7-3/4"	5-5/8"	1/2"	2-1/4"	<b>8</b>	05.5248.2301	9"		3/8"	2"
<b>4</b>	05.362.211	8-15/16"	7-13/16"	9/16"	2-1/2"	<b>9</b>	05.0262.0141	5-7/8"		1"	1-5/8"
<b>5</b>	05.262.131	5-1/16"		7/16"	1-5/16"	<b>10</b>	05.0262.0161	6-1/2"		1"	1-5/8"

# LARGE EURO PEWTER PULLS

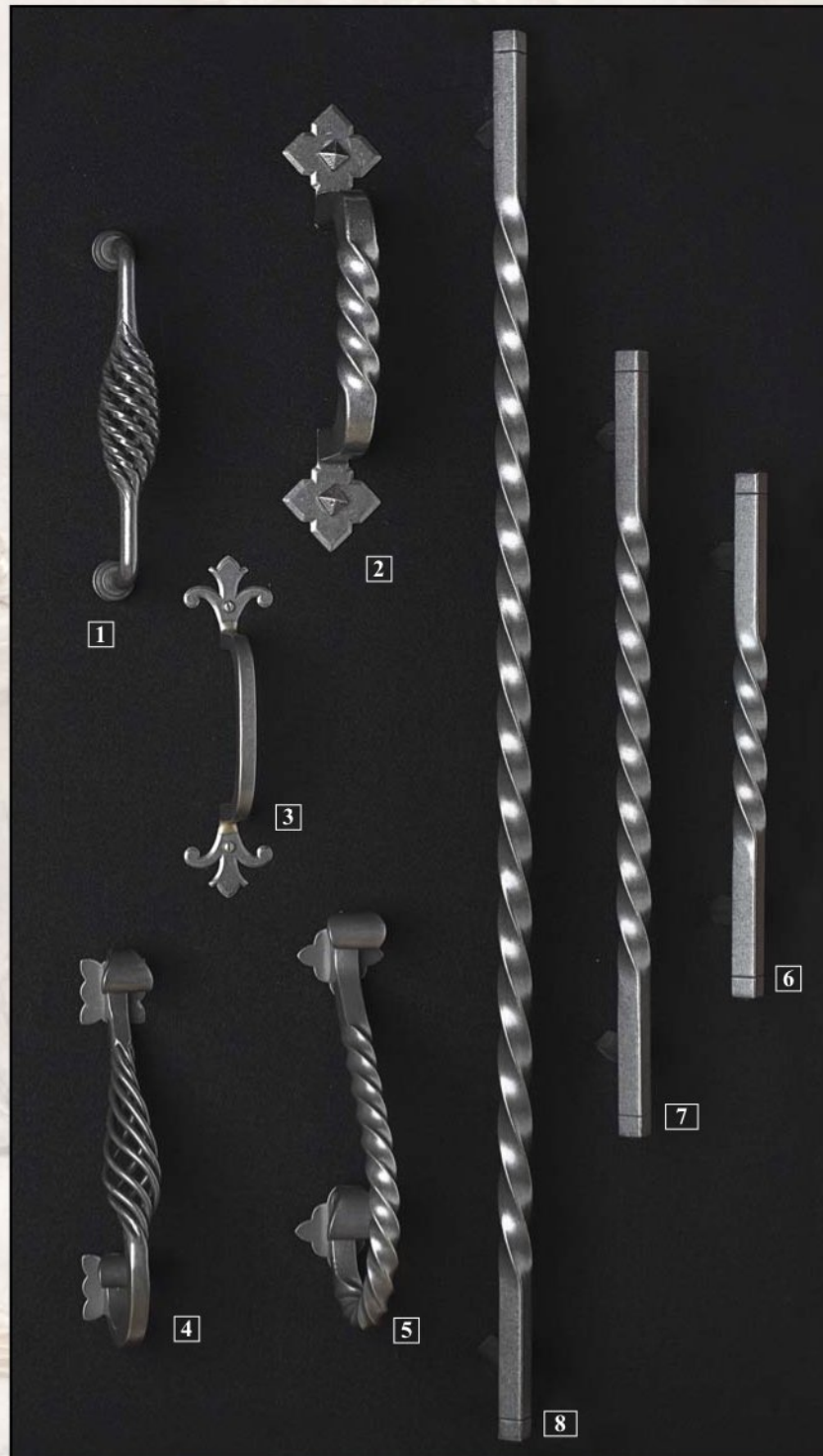

**NOTE:** Sold in euro pewter which is a galvanized steel and is suitable for outdoor.

IRON		A	B	C	D	IRON	A	B	C	D	
<b>1</b>	05.1384.203	9-7/8"	8"	1-1/2"	3"	<b>5</b>	19.38	10"	6-3/4"	3/4"	4-3/4"
<b>2</b>	19.1225.1	11"	8-3/4"	1"	3"	<b>6</b>	19.1378.351	14-3/8"	8-7/8"	7/8"	2-1/2"
<b>3</b>	19.1231.2051	8-1/4"	5-3/4"	3/8"		<b>7</b>	19.1378.501	19-1/2"	15-1/8"	7/8"	2-1/2"
<b>4</b>	19.35.1	9-1/2"	7-1/8"	1-1/2"	3-1/2"	<b>8</b>	19.1378.801	34"	30"	7/8"	2-1/2"



# IRON BIRDCAGE COLLECTION

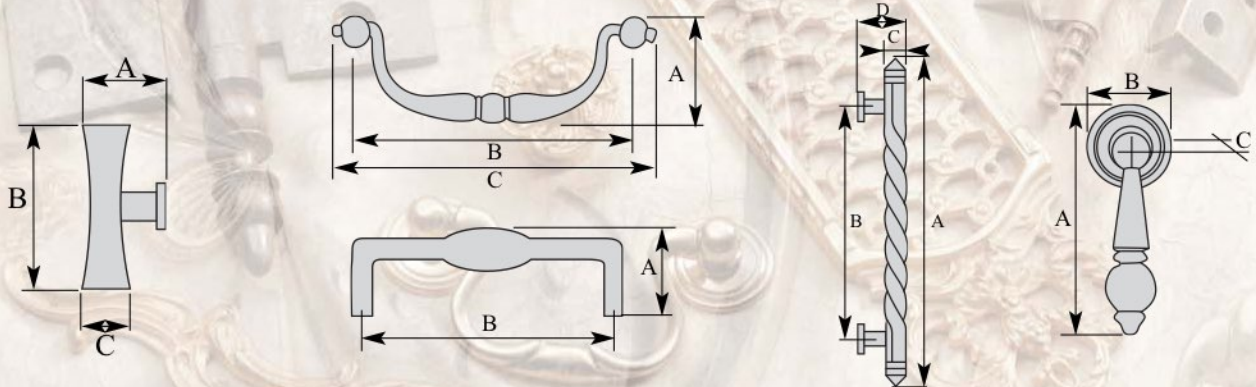
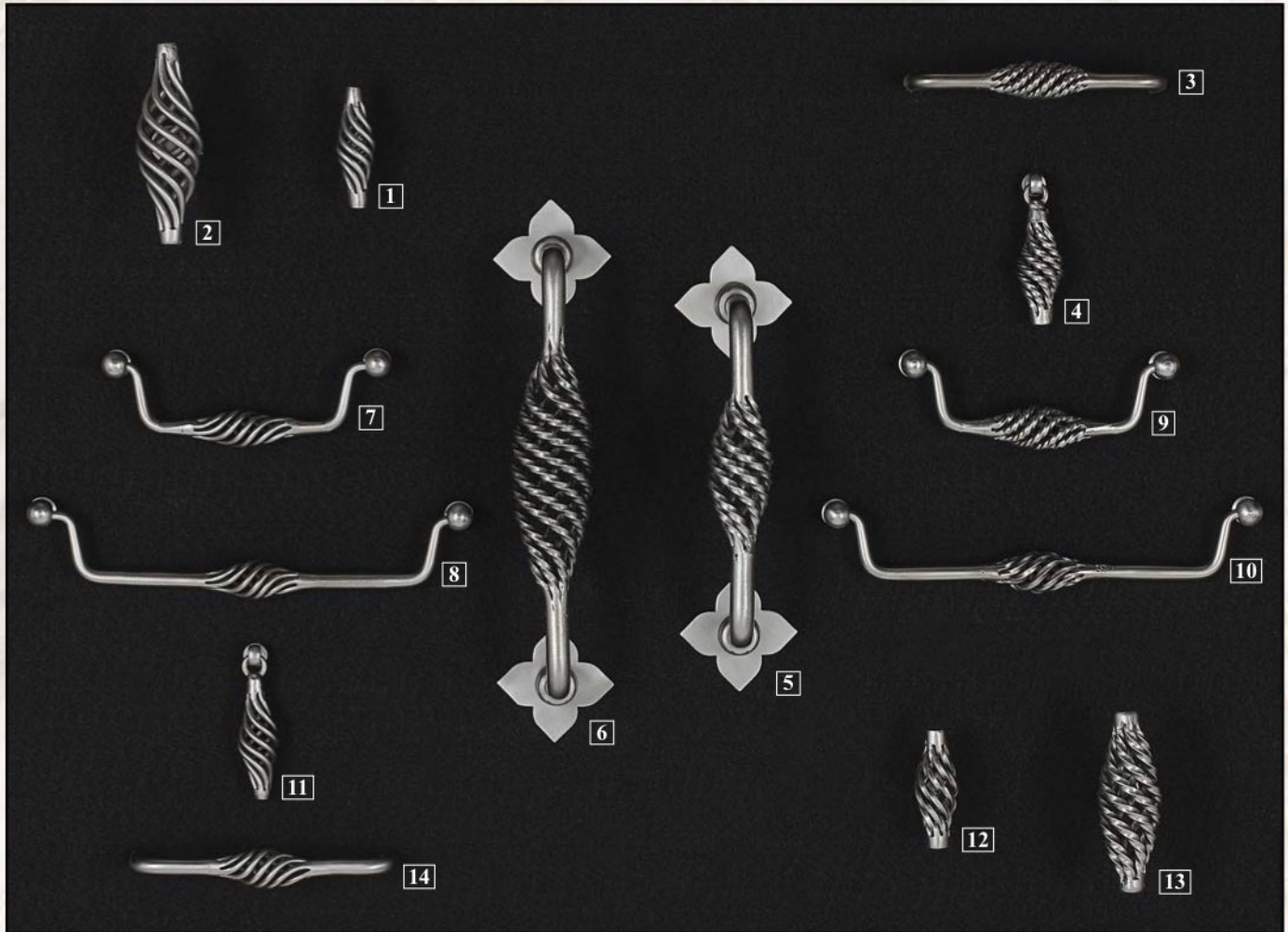

IRON		A	B	C	D	IRON	A	B	C	D
<b>1</b>	06.2029.0561	1-3/8"	2-3/16"	3/4"		<b>8</b>	05.1592.1921	1-3/4"	7-1/2"	7-5/8"
<b>2</b>	06.2029.0851	2-3/8"	3-9/16"	1-1/4"		<b>9</b>	05.1593.1281	1-3/4"	5"	5-1/8"
<b>3</b>	05.1595.0001	1-5/8"	4-1/2"			<b>10</b>	05.1593.1921	1-3/4"	7-1/2"	7-5/8"
<b>4</b>	07.1594.0001	2-3/4"	3/4"	3/4"		<b>11</b>	07.1595.0001	2-3/4"	3/4"	5/8"
<b>5</b>	05.1384.151	8-3/16"	5-7/8"	1-3/8"	2"	<b>12</b>	06.2028.0561	1-9/16"	2-3/16"	7/8"
<b>6</b>	05.1384.191	10"	8"	1-1/2"	2"	<b>13</b>	06.2028.0851	1-3/8"	3-9/16"	1-1/4"
<b>7</b>	05.1592.1281	1-3/4"	5"	5-1/8"		<b>14</b>	05.1596.0001	1-5/8"	4-1/2"	

# BRASS PULLS

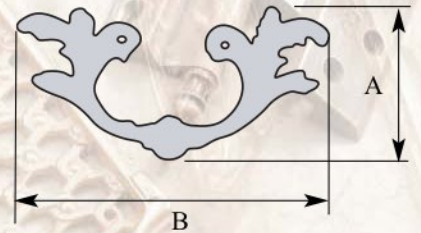
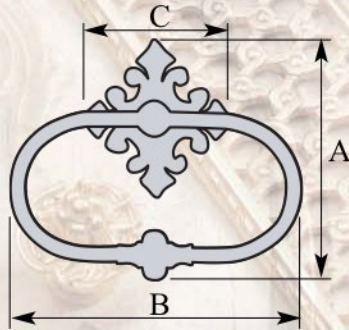
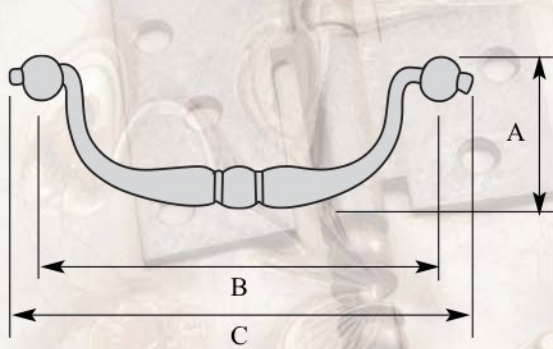
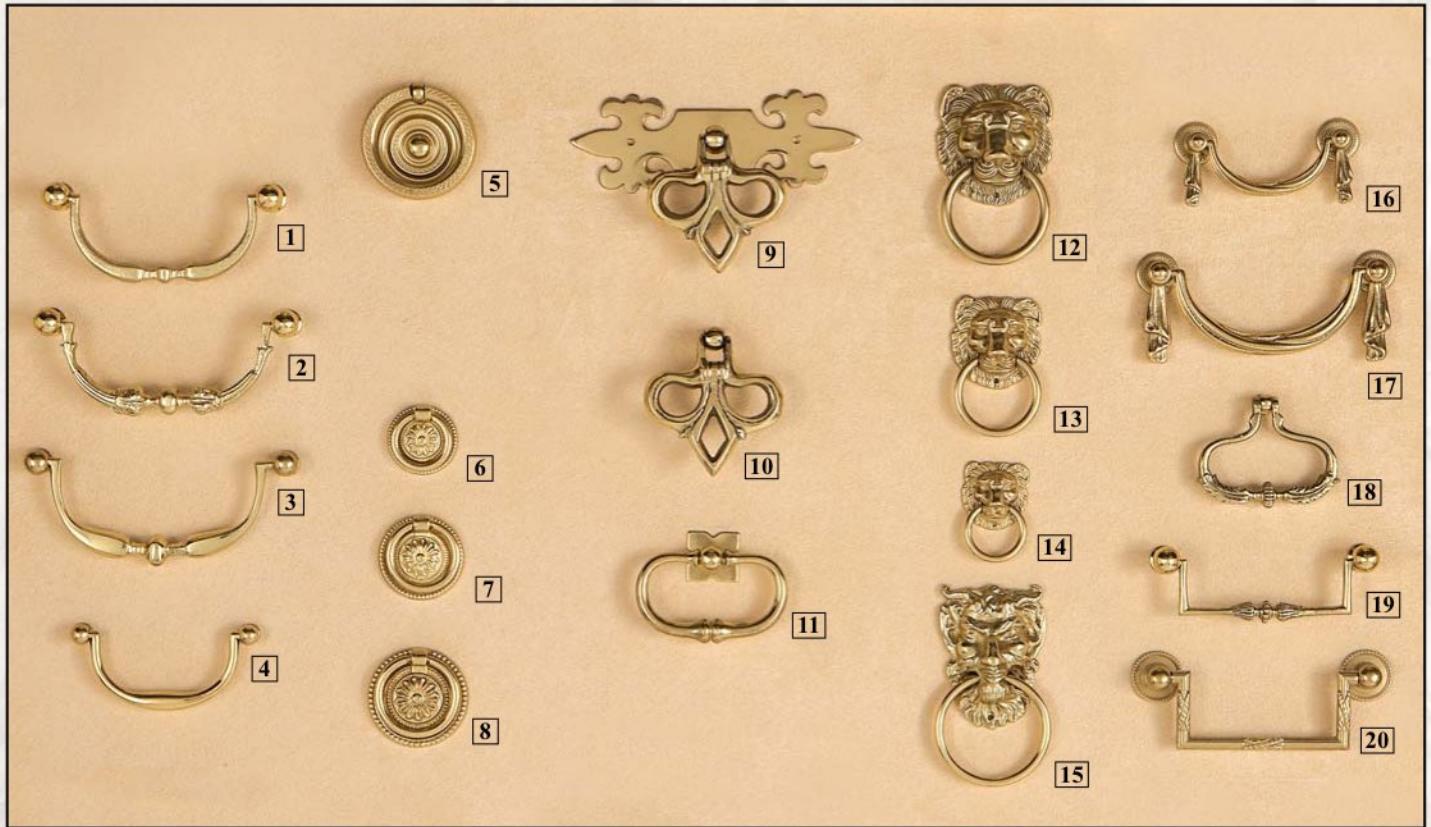

BRASS		A	B	C
<b>1</b>	05.749.2	1-7/8"	3-7/8"	
<b>2</b>	05.0687.1102	1-3/4"	4-3/8"	
<b>3</b>	05.0597.1102	1-3/4"	4-3/8"	
<b>4</b>	05.4123.0002	1-1/2"	3"	
<b>5</b>	05.2292.502	2-1/8"	2-1/8"	
<b>6</b>	05.37.332	1-1/4"	1-1/4"	
<b>7</b>	05.37.392	1-9/16"	1-9/16"	
<b>8</b>	05.37.462	1-13/16"	1-13/16"	
<b>9</b>	05.3139.00K2	3-1/4"		5-1/8"
<b>10</b>	05.3139.2.5	2-5/8"	2-1/2"	

BRASS		A	B	C
<b>11</b>	05.223.2	2-1/8"	2-3/4"	
<b>12</b>	05.252.52	3-1/4"	2-1/16"	
<b>13</b>	05.252.42	2-9/16"	1-9/16"	
<b>14</b>	05.252.32	1-7/8"	1-3/16"	
<b>15</b>	05.0825.1802	3-5/8"	2-1/8"	
<b>16</b>	05.1381.0962	1-9/16"	2-9/16"	3-5/16"
<b>17</b>	05.1381.1302	2-1/16"	3-13/16"	4-9/16"
<b>18</b>	05.0051.0652	2"	2-1/2"	
<b>19</b>	05.703.2	1-1/2"	3-5/8"	
<b>20</b>	05.2150.2	1-7/8"	4-1/16"	5"

# BRASS PULLS

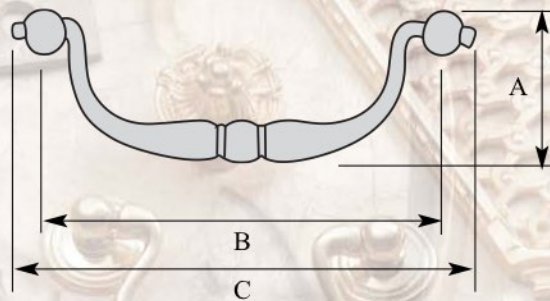
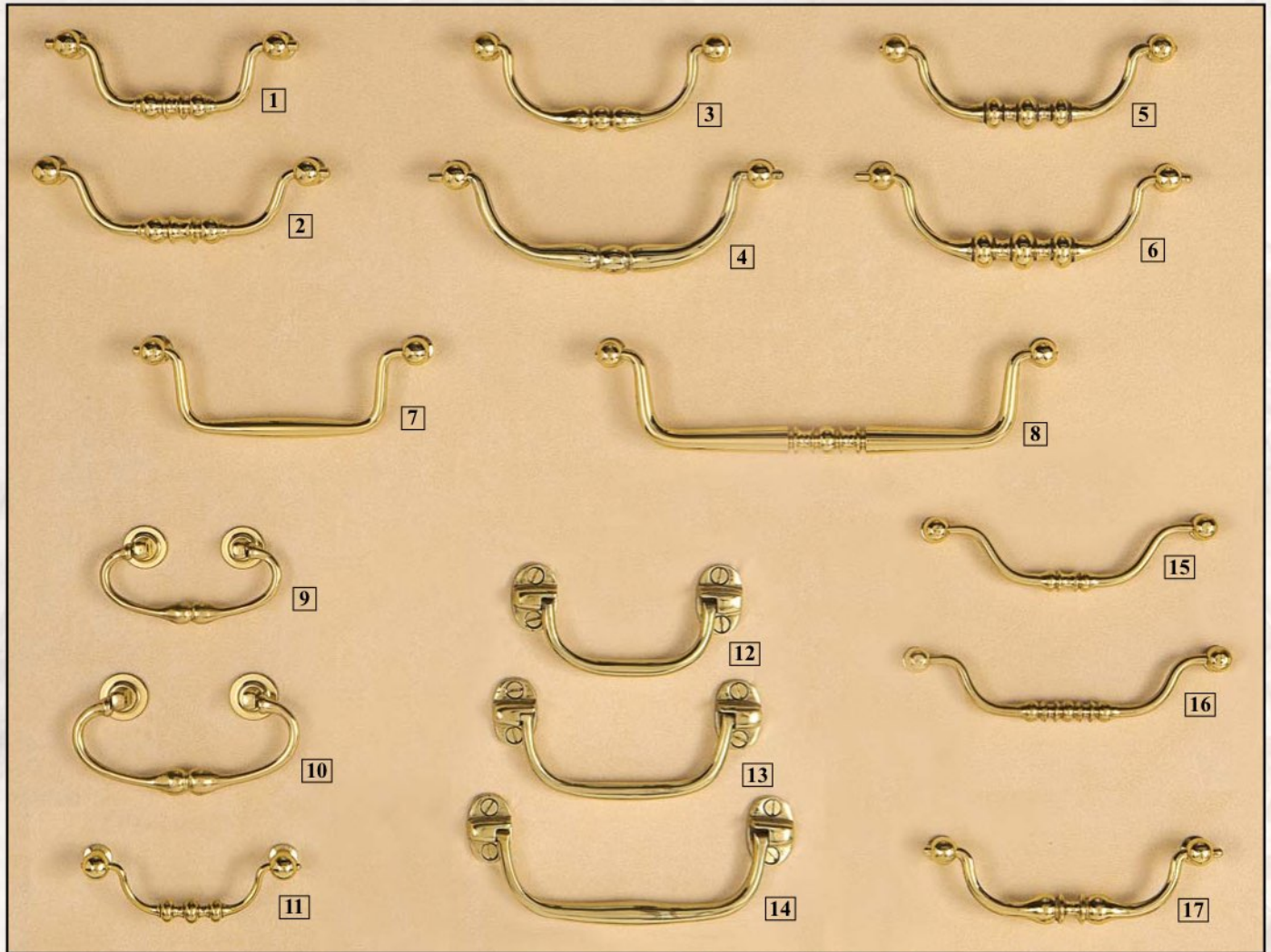

BRASS		A	B	C
<b>1</b>	05.2020.0962	1-1/2"	3-3/4"	4-3/8"
<b>2</b>	05.2020.1152	1-1/2"	4-1/2"	5-1/8"
<b>3</b>	05.1554.2	1-5/8"	4"	4-9/16"
<b>4</b>	05.1554.142	1-13/16"	5-1/2"	5-15/16"
<b>5</b>	05.1279.2	1-5/8"	4-5/8"	5-3/16"
<b>6</b>	05.1279.142	2"	5-1/8"	6"
<b>7</b>	05.1503.1152	1-7/8"	4-1/2"	5-1/8"
<b>8</b>	05.2025.1902	1-7/8"	7-1/2"	8-1/8"
<b>9</b>	05.4465.0802	1/2"	1-7/8"	3-1/4"

BRASS		A	B	C
<b>10</b>	05.4465.1002	9/16"	2-3/8"	4"
<b>11</b>	05.900.2	1-3/8"	3-1/4"	3-3/4"
<b>12</b>	05.0255.0112	1-7/8"		4"
<b>13</b>	05.0255.0122	2-1/16"		4-5/8"
<b>14</b>	05.0255.0142	2-1/4"		5-5/8"
<b>15</b>	05.1256.1252	1-3/8"	4-5/8"	5-1/8"
<b>16</b>	05.1256.1402	1-9/16"	5-7/16"	6-1/2"
<b>17</b>	05.0021.1152	1-1/2"	4-1/2"	5-1/8"

# BRASS PULLS

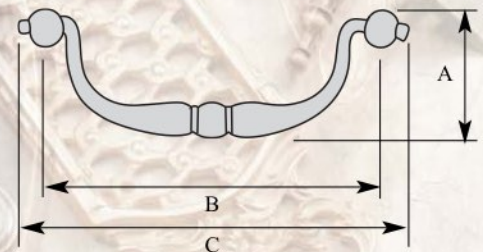
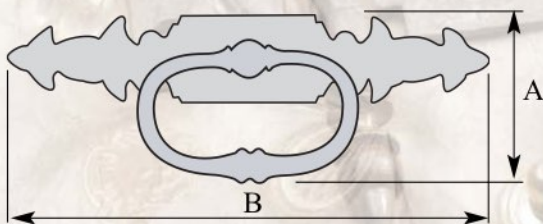
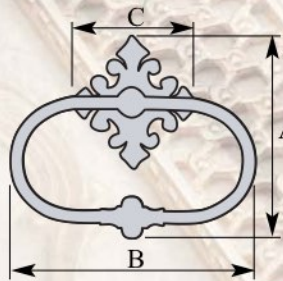
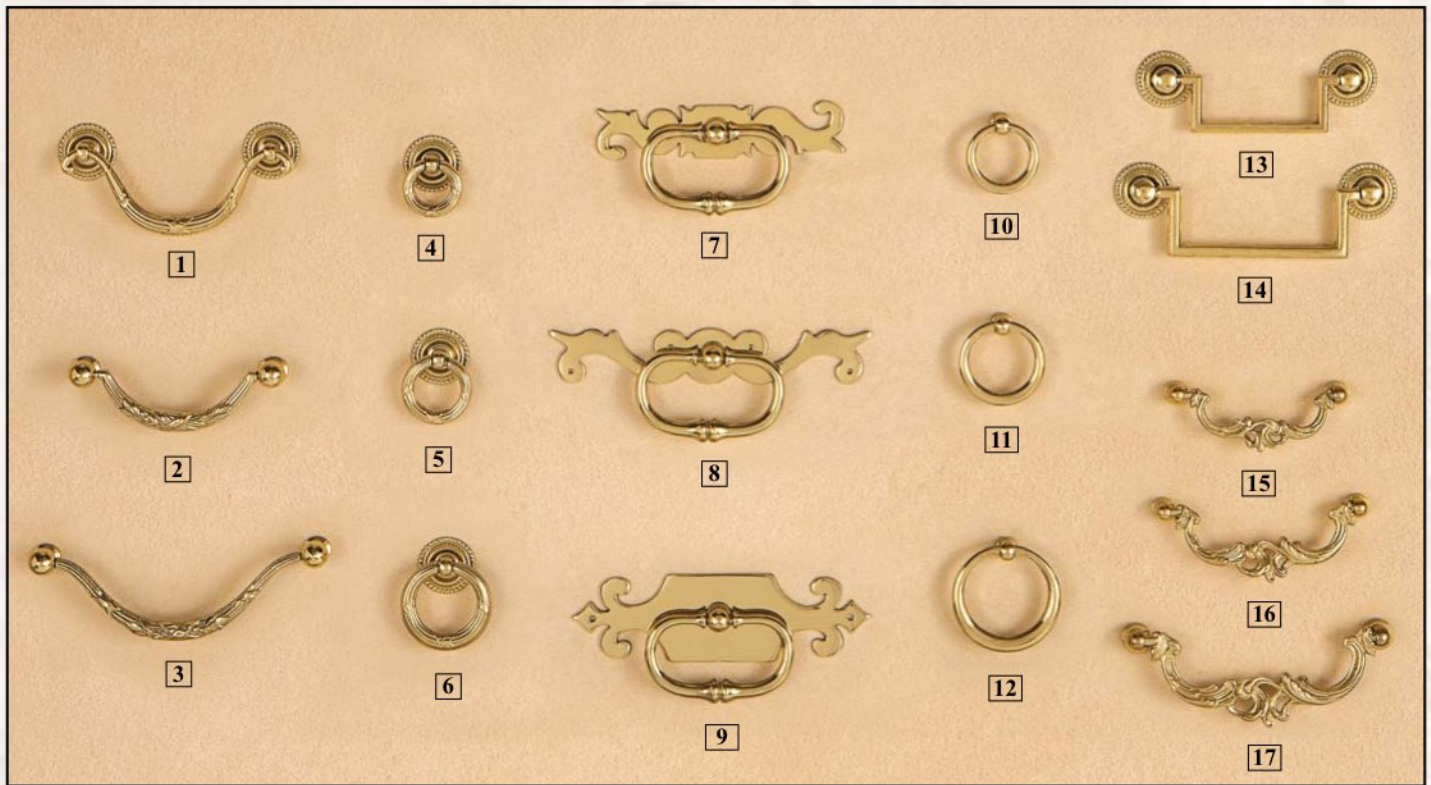

BRASS		A	B	C
<b>1</b>	05.4121.2	1-15/16"	3-3/8"	4-7/16" <sup>2</sup>
<b>2</b>	05.264.2	1-5/16"	3-1/2"	4"
<b>3</b>	05.275.2	1-11/16"	5"	5-7/16"
<b>4</b>	05.4122.302	1-1/2"	1-1/8"	
<b>5</b>	05.4122.352	1-11/16"	1-5/16"	
<b>6</b>	05.4122.402	2"	1-11/16"	
<b>7</b>	05.0603.00K2	2"	4-1/2"	
<b>8</b>	05.0606.00K2	2-1/8"	6"	
<b>9</b>	05.3140.00K2	2-7/16"	5-1/2"	

BRASS		A	B	C
<b>10</b>	05.0116.0342	1-3/8"	1-3/8"	
<b>11</b>	05.0116.0402	1-5/8"	1-5/8"	
<b>12</b>	05.0116.0502	2"	2"	
<b>13</b>	05.4120.832	1-1/2"	3-1/4"	4-1/4"
<b>14</b>	05.4120.102	1-3/4"	4-1/16"	5"
<b>15</b>	05.4530.0702	1-1/4"	2-13/16"	3-3/16"
<b>16</b>	05.4530.0902	1-1/2"	3-7/16"	3-7/8"
<b>17</b>	05.4530.1102	1-3/4"	4-1/2"	4-1/4"

# BRASS PULLS

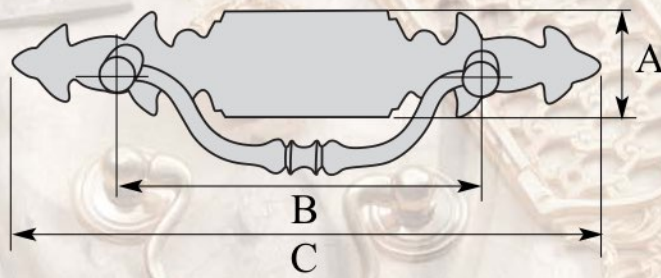
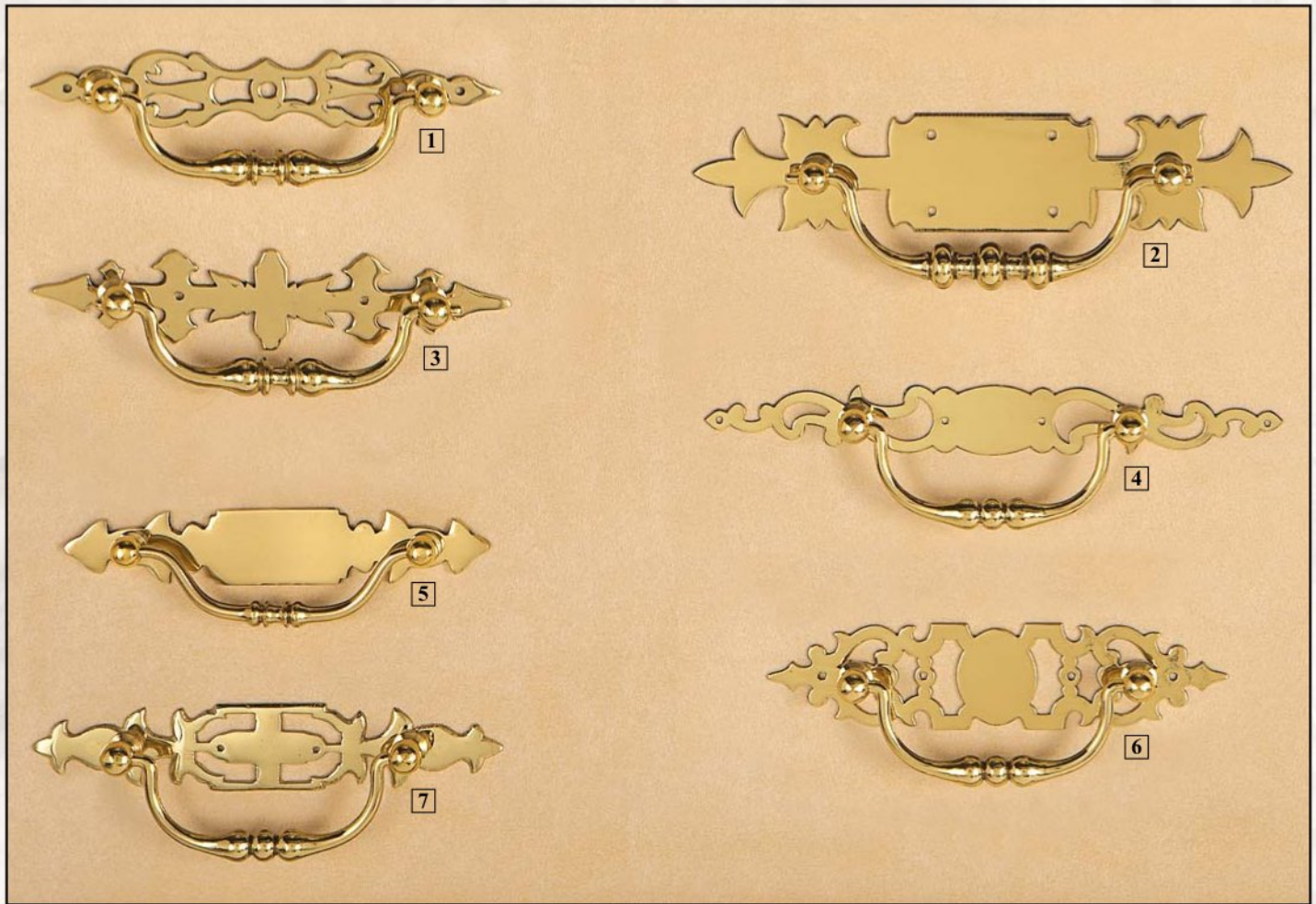

BRASS	A	B	C
<b>1</b> 05.3138.00K2	2-1/8"	4-5/8"	6-7/8"
<b>2</b> 05.5190.00K2	1-3/4"	5-1/8"	8-3/4"
<b>3</b> 05.3132.00K2	2-1/8"	4-5/8"	6-5/8"
<b>4</b> 05.2054.00K2	2-1/16"	4"	8-1/2"

BRASS	A	B	C
<b>5</b> 05.0605.00K2	1-7/8"	4-3/8"	6-3/8"
<b>6</b> 05.2028.00K2	2-1/8"	4"	6-7/8"
<b>7</b> 05.9095.00K2	1-3/4"	4"	6-3/4"

# BRASS PULLS

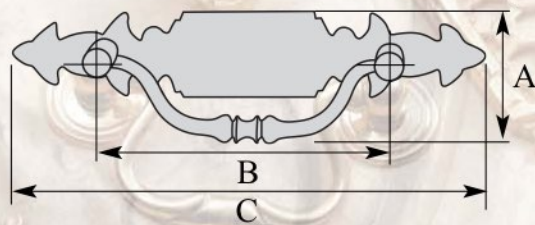
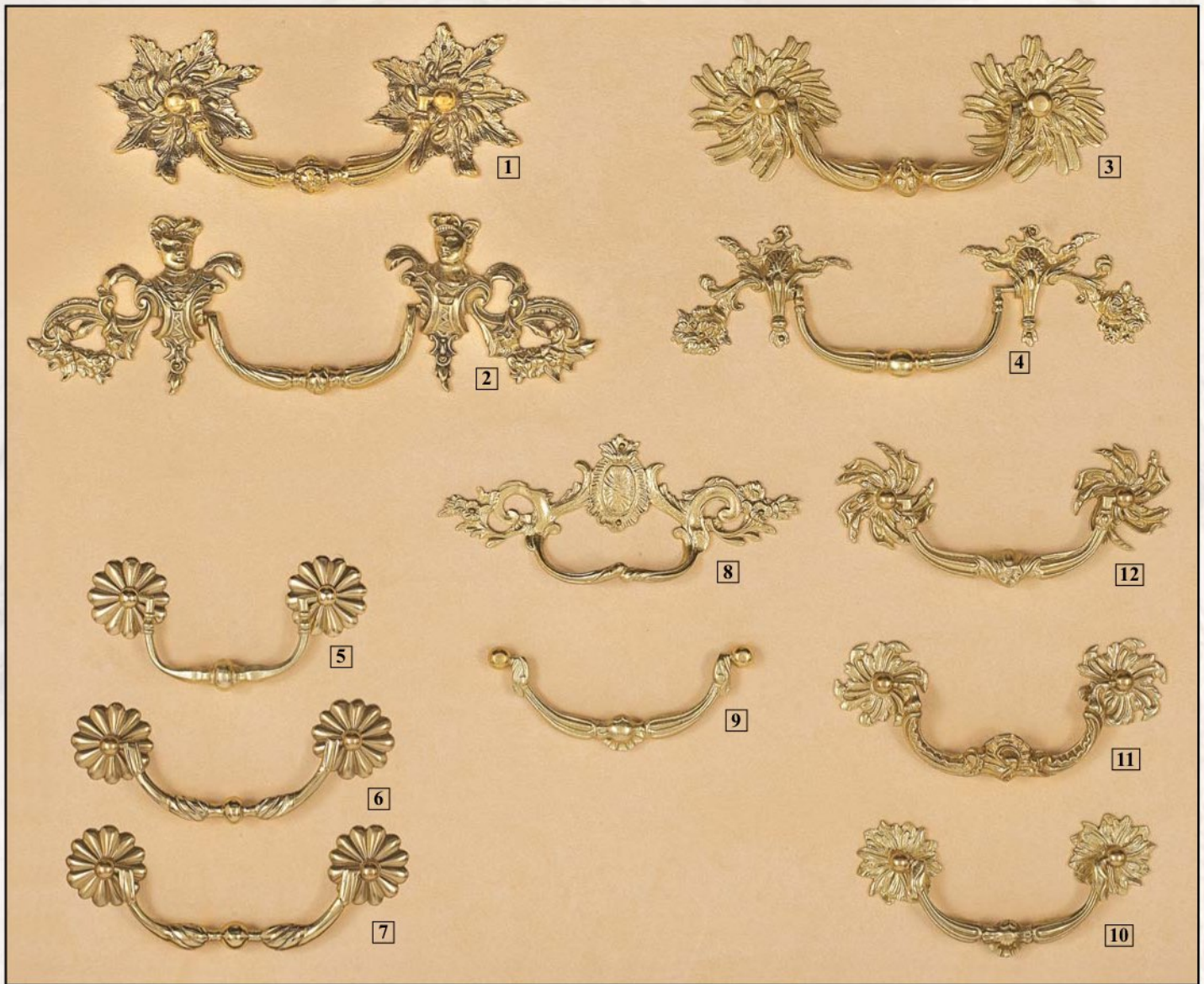

BRASS	A	B	C
<b>1</b> 05.1425.2	3-1/2"	5-11/16"	9-1/4"
<b>2</b> 05.1415	4"		12"
<b>3</b> 05.2074	3-1/2"	5-13/16"	9"
<b>4</b> 05.0812.2552	3-1/4"		10"
<b>5</b> 05.2439	2-7/8"	4-1/8"	5-7/8"
<b>6</b> 05.237	2-5/8"	5-1/16"	6-7/8"

BRASS	A	B	C
<b>7</b> 05.239	3-1/8"	5-1/2"	7-3/16"
<b>8</b> 05.0693.2002	3-1/4"		7-3/4"
<b>9</b> 05.2610.2	2-1/4"	5-1/4"	5-3/4"
<b>10</b> 05.2175.2	3-1/8"	5-1/8"	6-3/8"
<b>11</b> 05.2176	3-1/8"	5-1/8"	7"
<b>12</b> 05.2177	3-1/4"	5-1/8"	7-1/4"



# BRASS PULLS

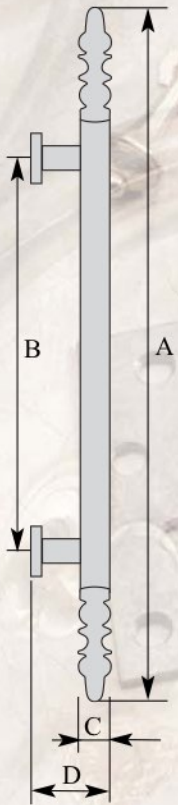

**NOTE:** For an added touch see rosettes pages 81 and 82.

BRASS		A	B	C	D
<b>1</b>	19.0009.0302	12"	5-9/16"	11/16"	2-1/4"
<b>2</b>	19.0009.0402	16"	7-3/16"	11/16"	2-1/4"
<b>3</b>	19.0009.0502	20"	11-1/8"	11/16"	2-1/4"
<b>3</b>	<small>NOT SHOWN</small> 19.0009.1002	39-3/8"	29-3/4"	11/16"	2-1/4"

BRASS		A	B	C	D
<b>4</b>	19.0005.0202	8-1/2"	4"	1/2"	1-5/8"
<b>5</b>	19.0005.0302	11-3/4"	6-1/2"	1/2"	1-5/8"
<b>6</b>	19.0005.0452	18-1/8"	12"	1/2"	1-5/8"
<b>6</b>	<small>NOT SHOWN</small> 19.0005.0602	19-1/4"	13-3/4"	1/2"	1-5/8"

# BRASS PULLS

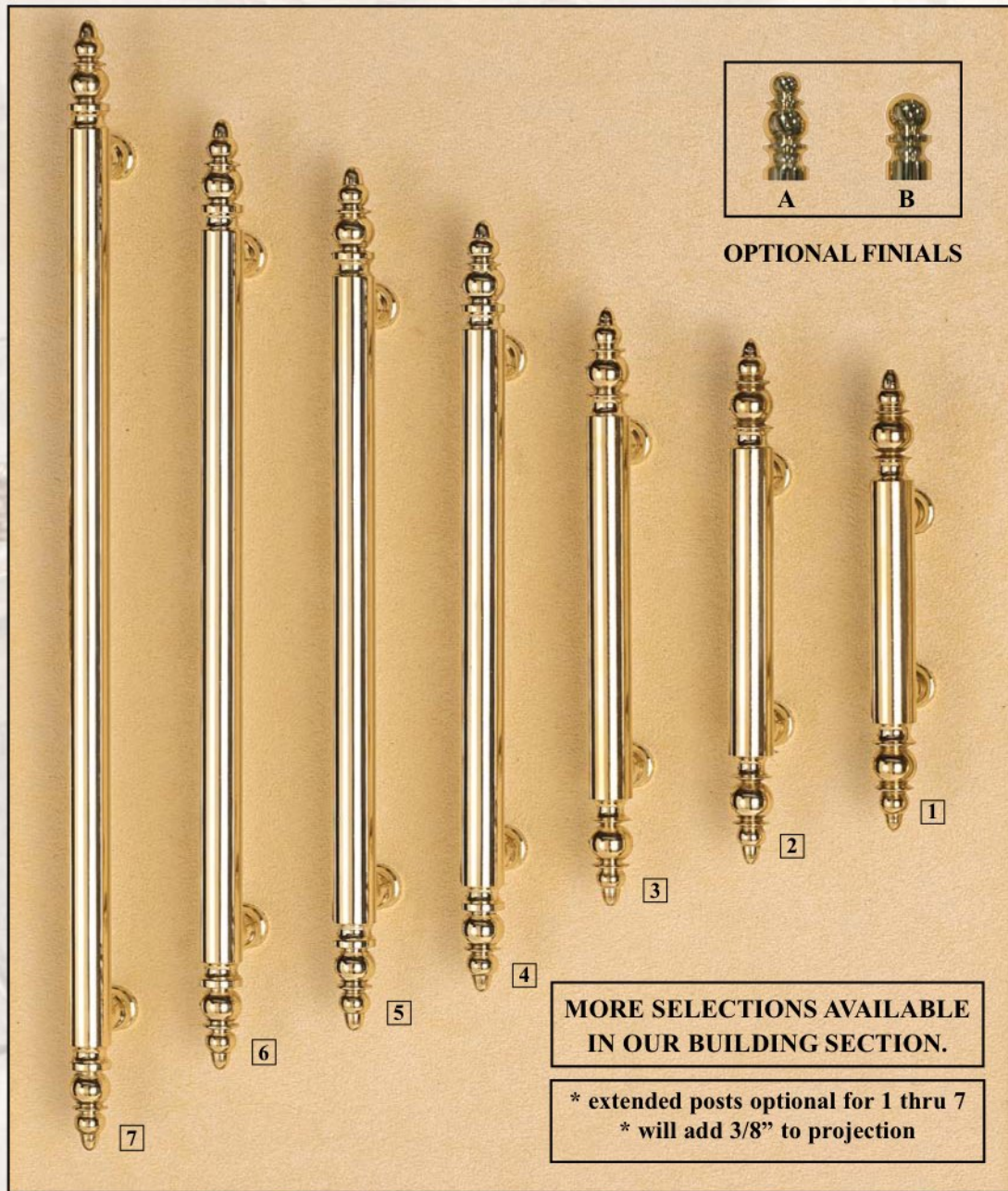

**NOTE:** For an added touch see rosettes pages 81 and 82.

BRASS		A	B	C	D	BRASS	A	B	C	D
<b>1</b>	05.41.1202	4-5/8"	1-3/4"	1/2"	1-1/16"	<b>5</b>	9"	6-1/8"	1/2"	1-1/16"
<b>2</b>	05.41.1402	5-3/8"	2-5/8"	1/2"	1-1/16"	<b>6</b>	10"	7-1/8"	1/2"	1-1/16"
<b>3</b>	05.41.1602	6-3/16"	3-3/8"	1/2"	1-1/16"	<b>7</b>	12"	9-1/8"	1/2"	1-1/16"
<b>4</b>	05.41.2002	8"	5-1/8"	1/2"	1-1/16"					



# BRASS PULLS COLLECTION

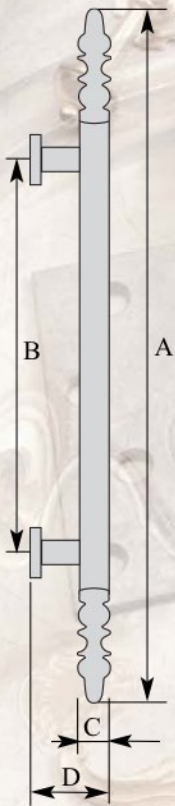

**NOTE:** For an added touch see rosettes pages 81 and 82.

BRASS		A	B	C	D
<b>1</b>	05.68.102	4-3/8"	3-3/4"	5/8"	1-5/8"
<b>2</b>	05.68.122	5-1/2"	5"	5/8"	1-5/8"
<b>3</b>	05.68.162	6-3/4"	6-5/16"	5/8"	1-5/8"
<b>4</b>	19.68.202	8-3/4"	8"	7/8"	2-3/8"
<b>5</b>	19.68.302	12-3/4"	12"	7/8"	2-3/8"
<b>6</b>	19.68.402	16-3/4"	16"	7/8"	2-3/8"

# BRASS PULLS



MORE SELECTIONS AVAILABLE  
IN OUR BUILDING SECTION.

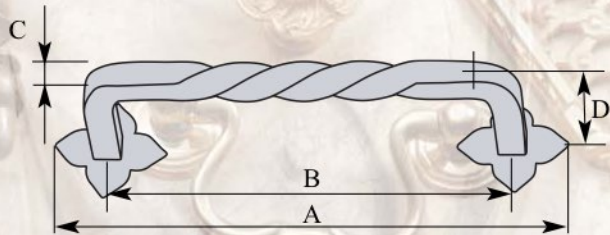
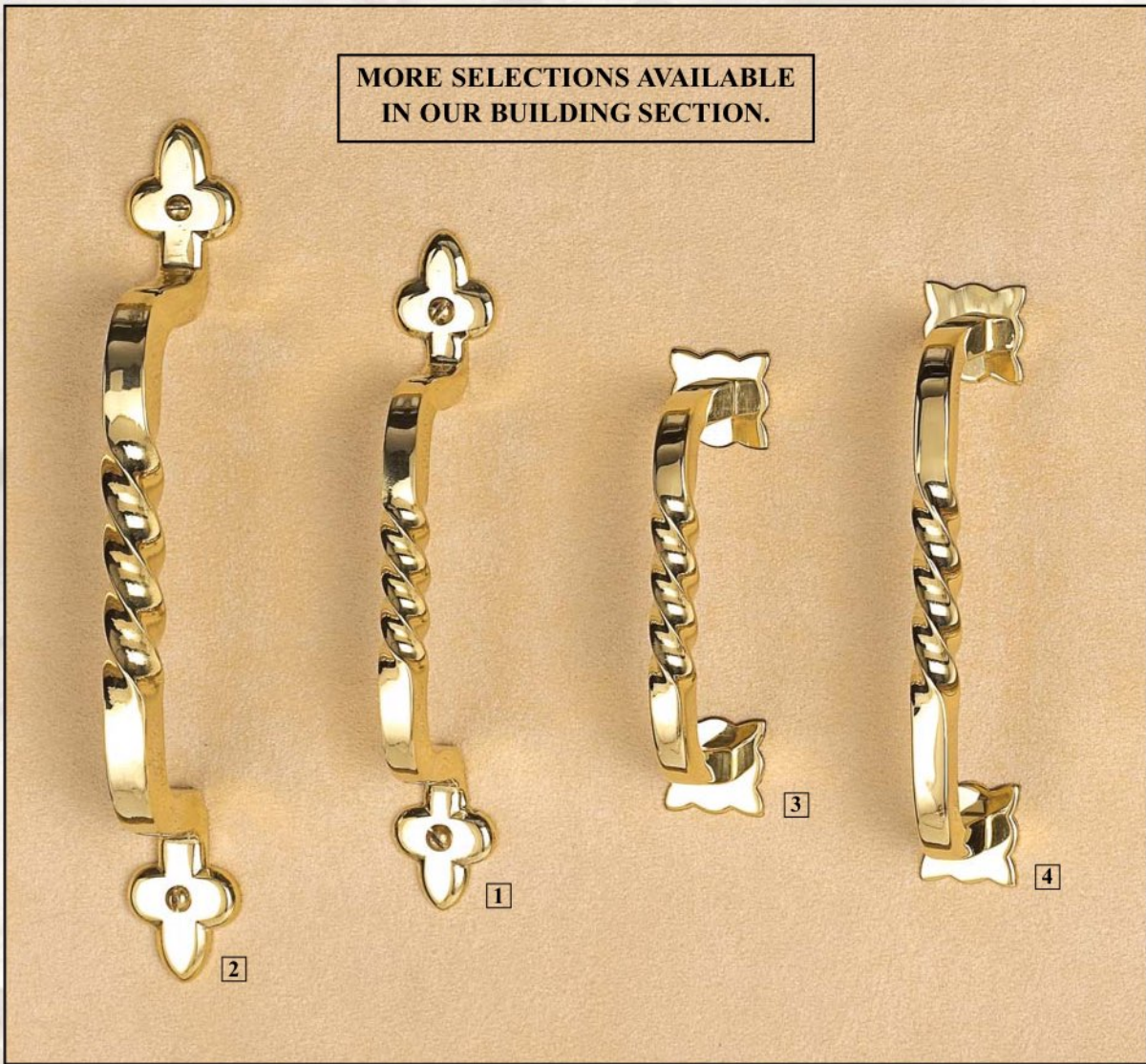

BRASS		A	B	C	D
<b>1</b>	05.263.142	5-3/8"	4-3/8"	5/16"	1-1/4"
<b>2</b>	05.263.182	7-1/8"	5-3/4"	3/8"	1-1/2"
<b>3</b>	05.362.82	3-3/4"	3"	5/16"	1-3/8"
<b>4</b>	05.362.102	4-7/8"	4"	5/16"	1-3/8"
<b>5</b> <small>NOT SHOWN</small>	19.1378.502*	19-1/2"	15-1/8"	7/8"	2-1/2"

\* See page 16 pull # 1 of our Building section.

# BRASS PULLS

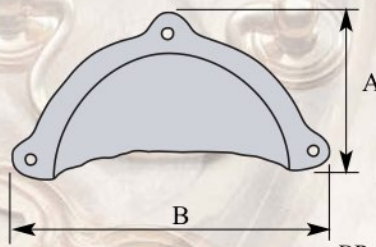

BRASS	A	B
<b>1</b> 05.01.02	1-5/16"	3-3/8"
<b>2</b> 05.02.02	1-1/2"	3-7/8"
<b>3</b> 05.0142.0962	1-3/4"	3-3/4"
<b>4</b> 05.454.2	1-1/2"	3-5/8"
<b>5</b> 05.265.2	1-5/8"	4"

BRASS	A	B
<b>6</b> 05.261.2	1-1/8"	3"
<b>7</b> 05.261.82	1-5/16"	3-7/16"
<b>8</b> 05.5032.0302	2"	1-1/2"
<b>9</b> 05.5032.0482	2-3/8"	1-7/8"
<b>10</b> 05.5022.0752	2"	2-15/16"

# BRASS PULLS

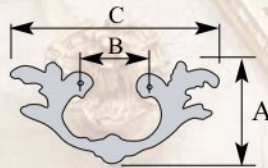
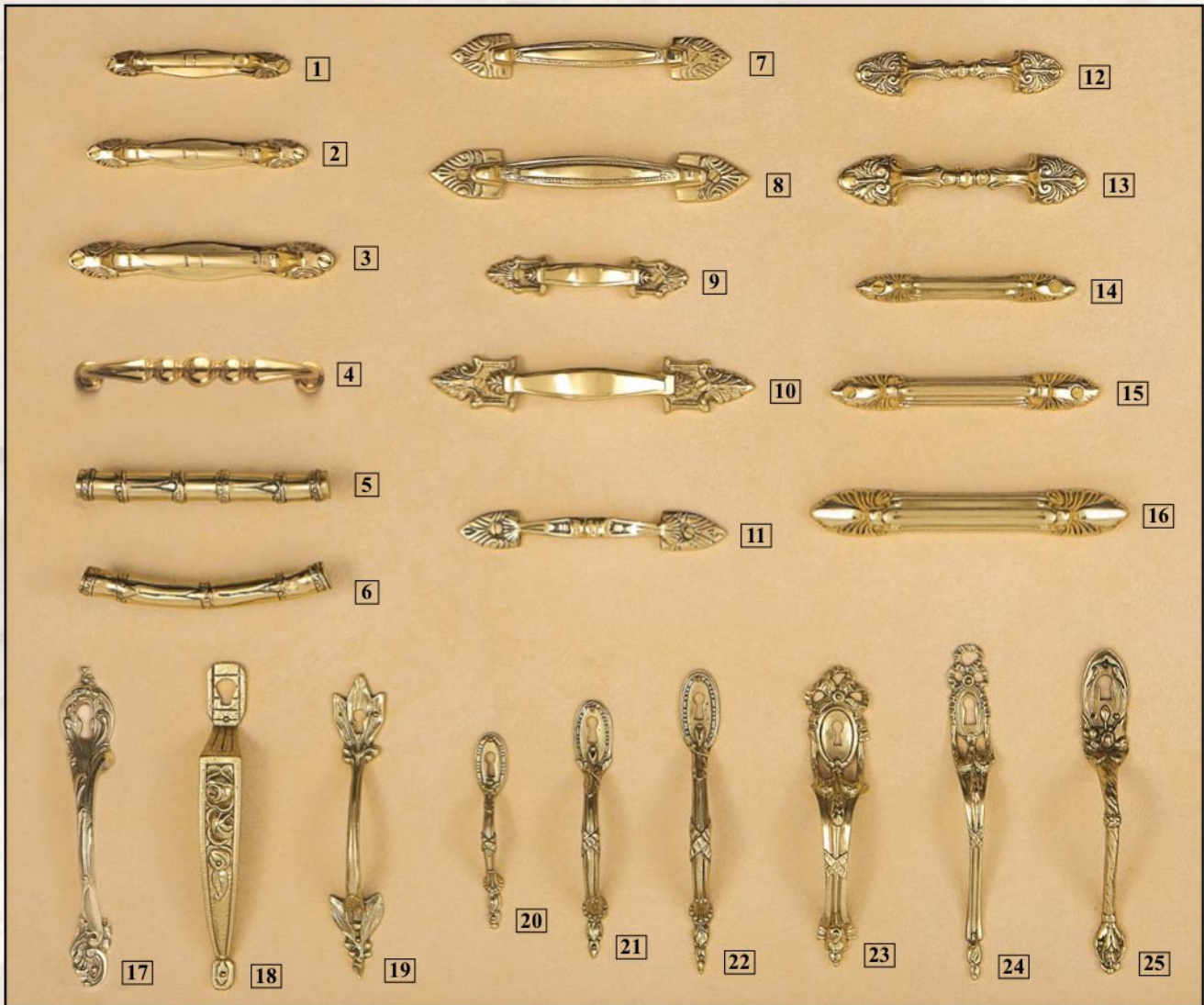

BRASS		A	B	C
<b>1</b>	05.3053.2	5/8"		4"
<b>2</b>	05.3037.2	11/16"		4-9/16"
<b>3</b>	05.3036.2	7/8"		5-1/2"
<b>4</b>	05.277.2	9/16"	3-7/8"	4-3/8"
<b>5</b>	05.3027.2	3/4"	3-7/8"	5-1/4"
<b>6</b>	05.3032.2	1-1/16"	3-7/8"	5-3/16"
<b>7</b>	05.3043.2	13/16"		5-9/16"
<b>8</b>	05.3021.2	1-1/16"		6-11/16"
<b>9</b>	05.3042.2	15/16"		4-3/8"
<b>10</b>	05.3024.2	1-3/8"		7-3/16"
<b>11</b>	05.3030.2	15/16"		5-13/16"
<b>12</b>	05.3045.2	15/16"	2-3/4"	4-3/8"
<b>13</b>	05.3019.2	1-1/8"	3-7/16"	5-1/4"

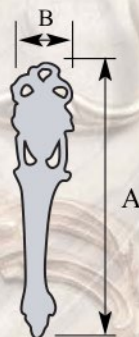

BRASS		A	B	C
<b>14</b>	05.3038.2	5/8"		4-9/16"
<b>15</b>	05.3040.2	13/16"		5-9/16"
<b>16</b>	05.3020.2	3/4"		6-3/4"
<b>17</b>	05.1965.2	61/4"	1-1/8"	
<b>18</b>	05.1933.2	5-3/16"	3/4"	
<b>19</b>	05.1934.2	6-11/16"	7/8"	
<b>20</b>	05.1952	6-7/16"	1-1/8"	
<b>21</b>	05.1963.0002	4-1/8"	3/4"	
<b>22</b>	05.1959.2	5-3/8"	7/8"	
<b>23</b>	05.1958	6-1/4"	7/8"	
<b>24</b>	05.1955	6-1/4"	1-3/8"	
<b>25</b>	05.1956.2	6-15/16"	7/8"	
<b>25</b>	05.1957	6-3/4"	1"	

# BRASS PULLS

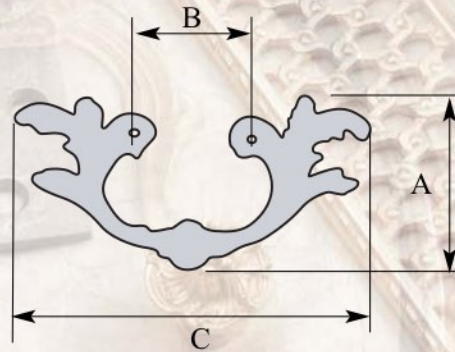
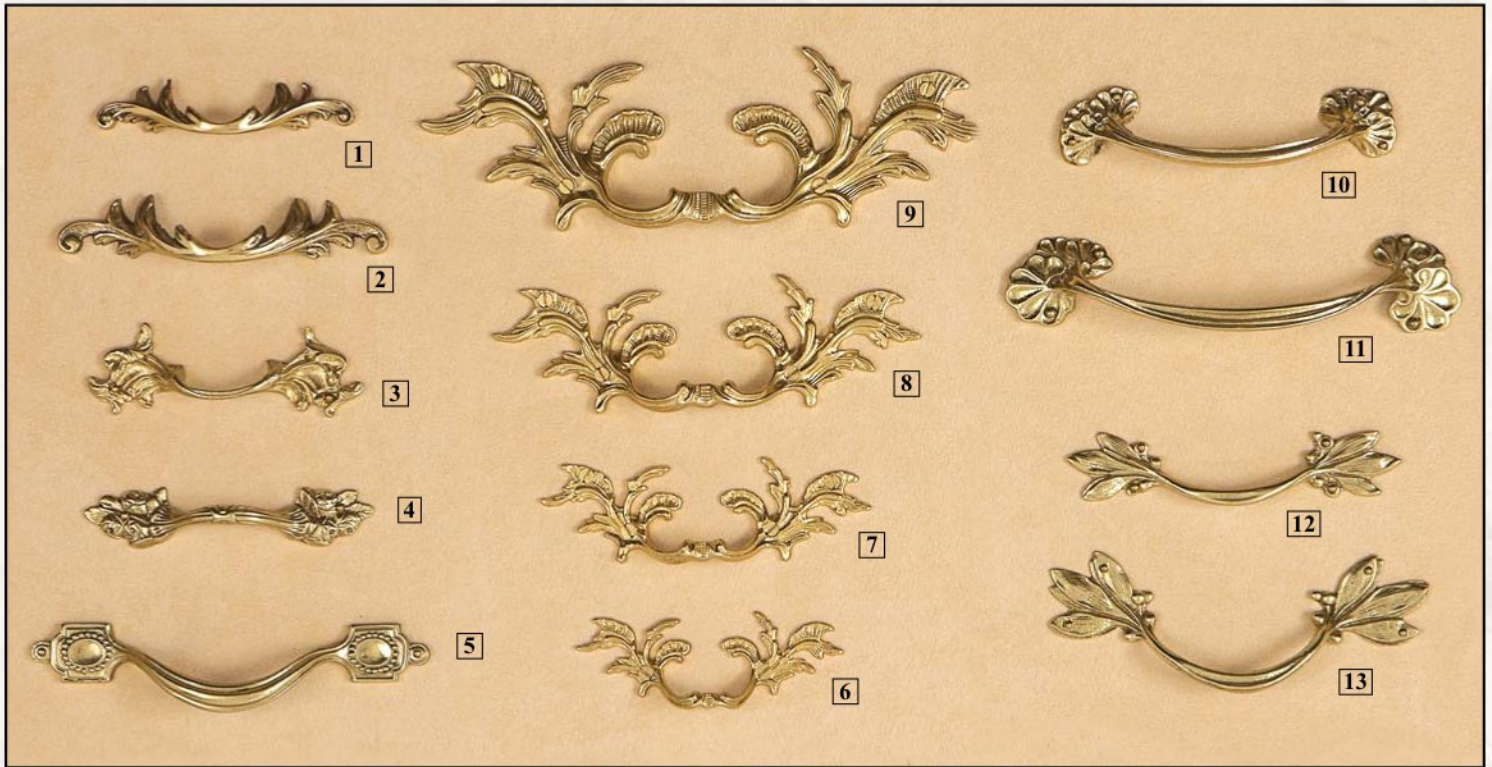

BRASS		A	B	C
<b>1</b>	05.5281.952	3/4"	2-1/2"	3-7/8"
<b>2</b>	05.5281.1252	1-1/16"	2-1/2"	4-7/8"
<b>3</b>	05.1083.0002	1-7/16"		4-1/16"
<b>4</b>	05.1913	15/16"		4-5/16"
<b>5</b>	05.1918	1-7/16"		5-13/16"
<b>6</b>	05.2076.1002	1-7/16"		3-15/16"
<b>7</b>	05.2076.1202	1-1/2"		4-7/8"

BRASS		A	B	C
<b>8</b>	05.2076.1552	2"		6-1/4"
<b>9</b>	05.2076.2102	2-3/4"		8-1/2"
<b>10</b>	05.1904.122	1-1/4"		5"
<b>11</b>	05.1904.172	1-1/2"		6-5/8"
<b>12</b>	05.1902.122	1-3/16"		4-7/8"
<b>13</b>	05.1902.142	1-15/16"		5-5/8"

# BRASS PULLS

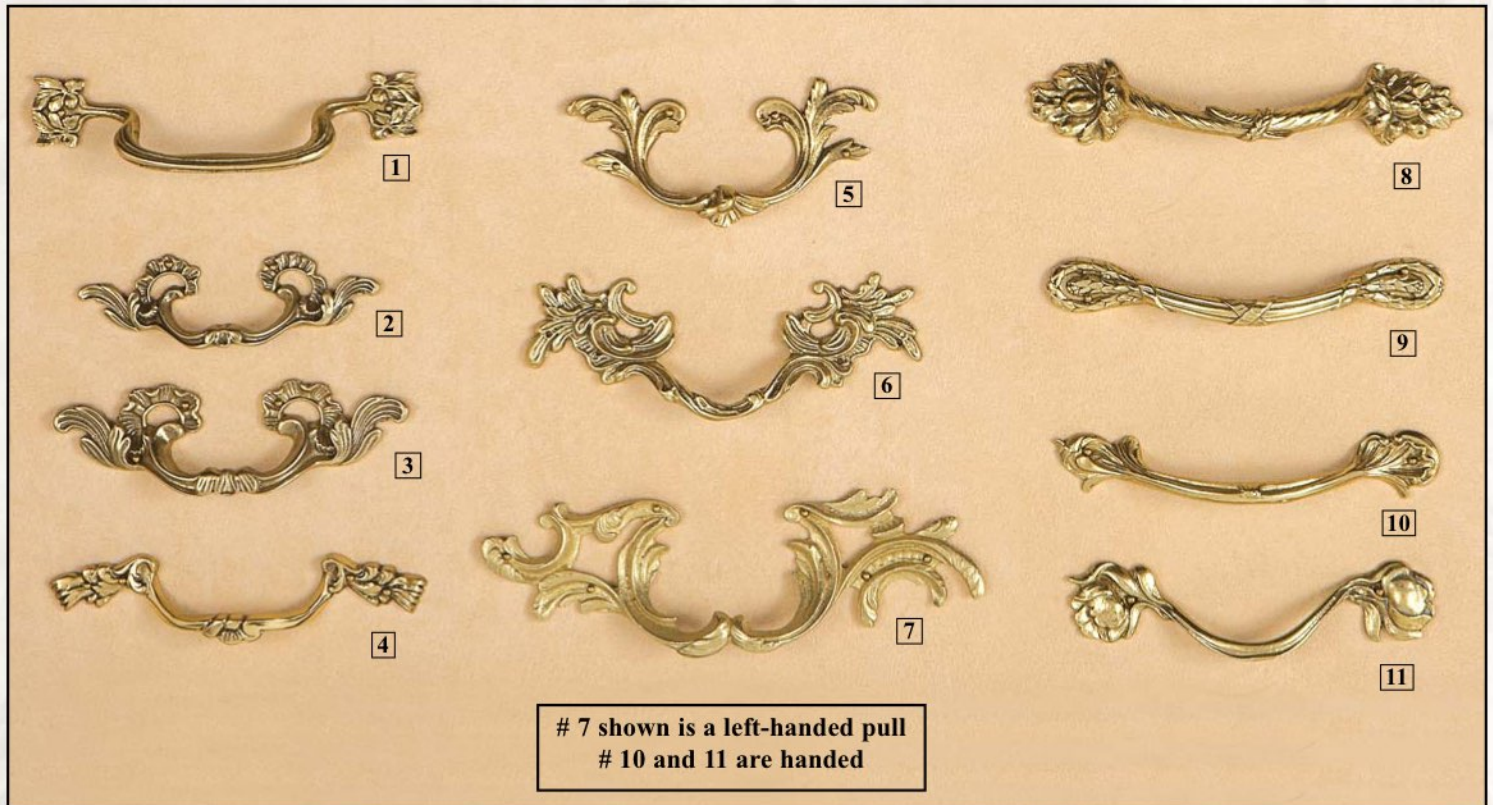

# 7 shown is a left-handed pull  
# 10 and 11 are handed

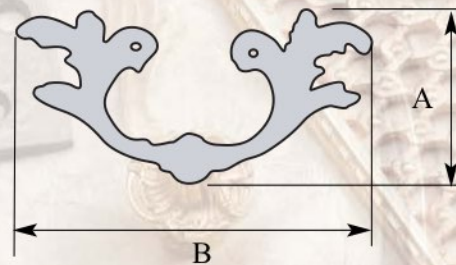

BRASS		A	B
<b>1</b>	05.1917	1-3/8"	5-13/16"
<b>2</b>	05.432.112	1-1/2"	4-7/16"
<b>3</b>	05.432.142	1-7/8"	5-1/2"
<b>4</b>	05.4281.132	1-7/16"	5-1/8"
<b>4</b>	05.4281.152	1-1/2"	5-11/16"
<b>5</b>	05.0113.0112	2-1/4"	4-1/2"
<b>6</b>	05.650.2	2-1/4"	6-3/4"

BRASS		A	B
<b>7</b> left	05.0636.002	2-1/2"	7-5/16"
<b>7</b> right	05.0635.002	2-1/2"	7-5/16"
<b>8</b>	05.1912	1-3/16"	6-3/8"
<b>9</b>	05.1915	1"	5-13/16"
<b>10</b>	05.1910	1-1/8"	5-11/16"
<b>11</b>	05.1916	1-3/8"	5-3/8"



# BRASS BIRDCAGE COLLECTION

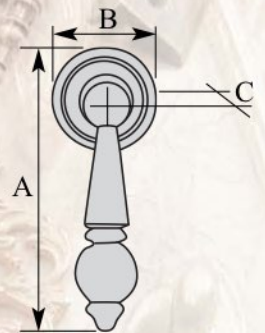
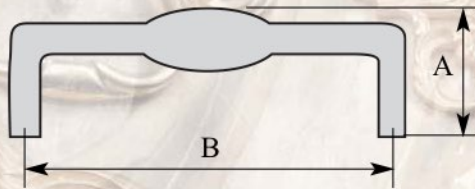
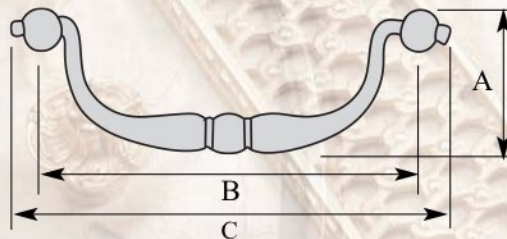
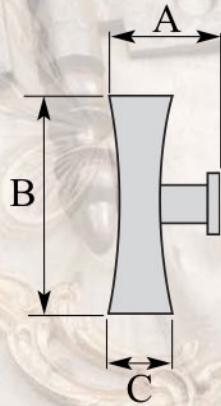
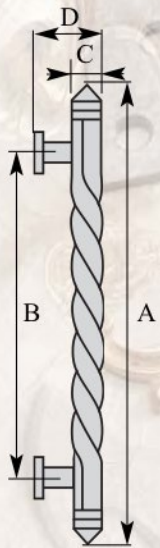
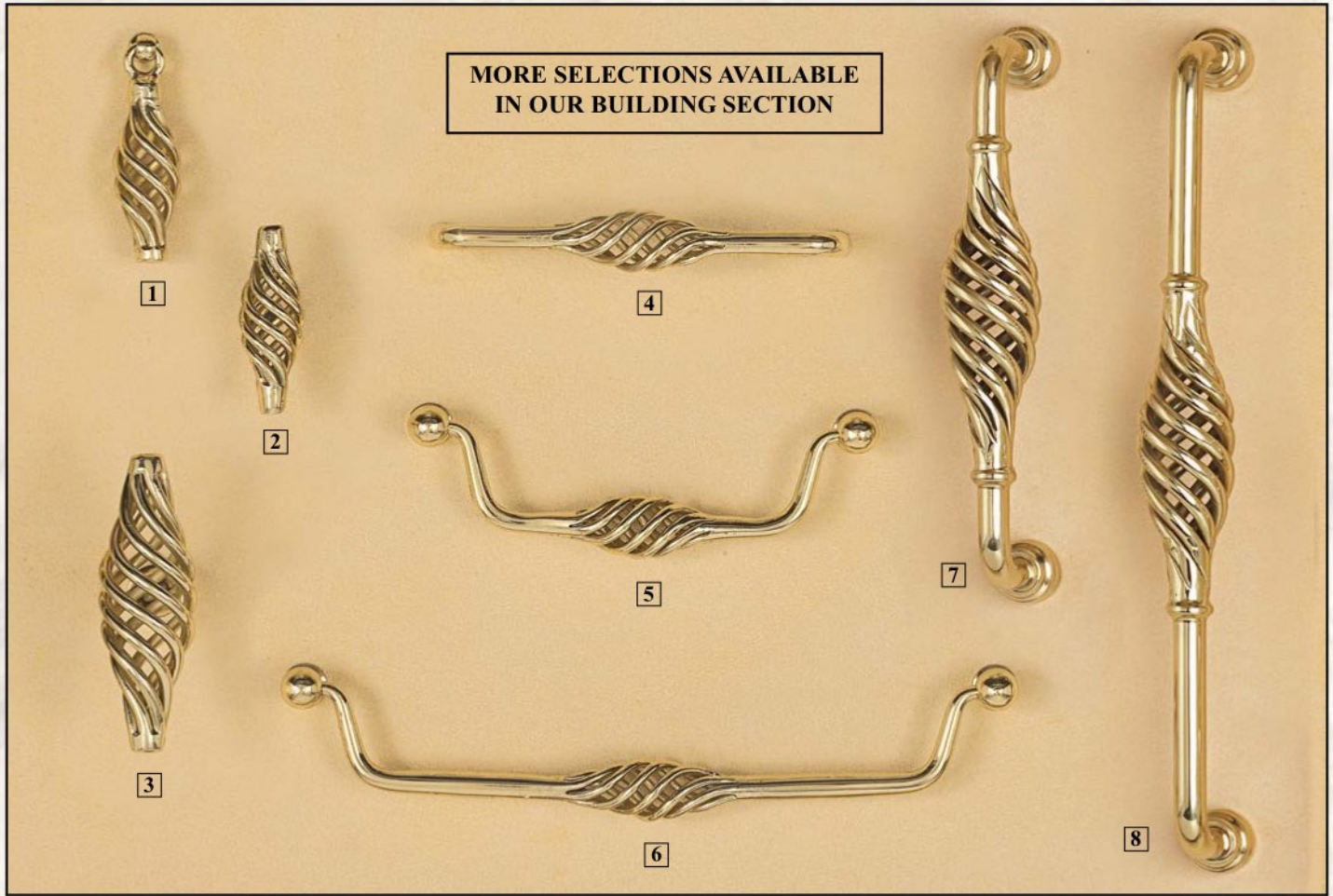

BRASS	A	B	C
<b>1</b> 07.1595.0002	2-3/4"	3/4"	5/8"
<b>2</b> 06.2029.0562	1-1/4"	2-3/16"	3/4"
<b>3</b> 06.2029.0852	2-3/8"	3-9/16"	1-1/4"
<b>4</b> 05.1596.0002	1-5/8"	4-1/2"	

BRASS	A	B	C
<b>5</b> 05.1592.1282	1-3/4"	5"	5-1/8"
<b>6</b> 05.1592.1922	1-3/4"	7-1/2"	7-5/8"
<b>7</b> 05.1384.202	8-7/8"	7-7/8"	1/2" 2-3/4"
<b>8</b> 05.1384.302	12-7/8"	11-7/8"	1/2" 3"

# IRON KNOBS

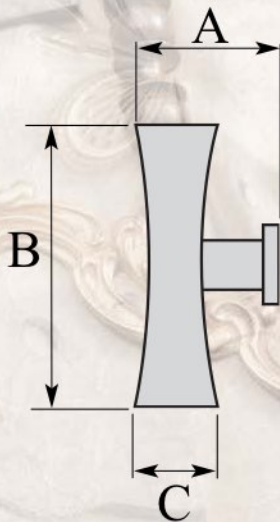
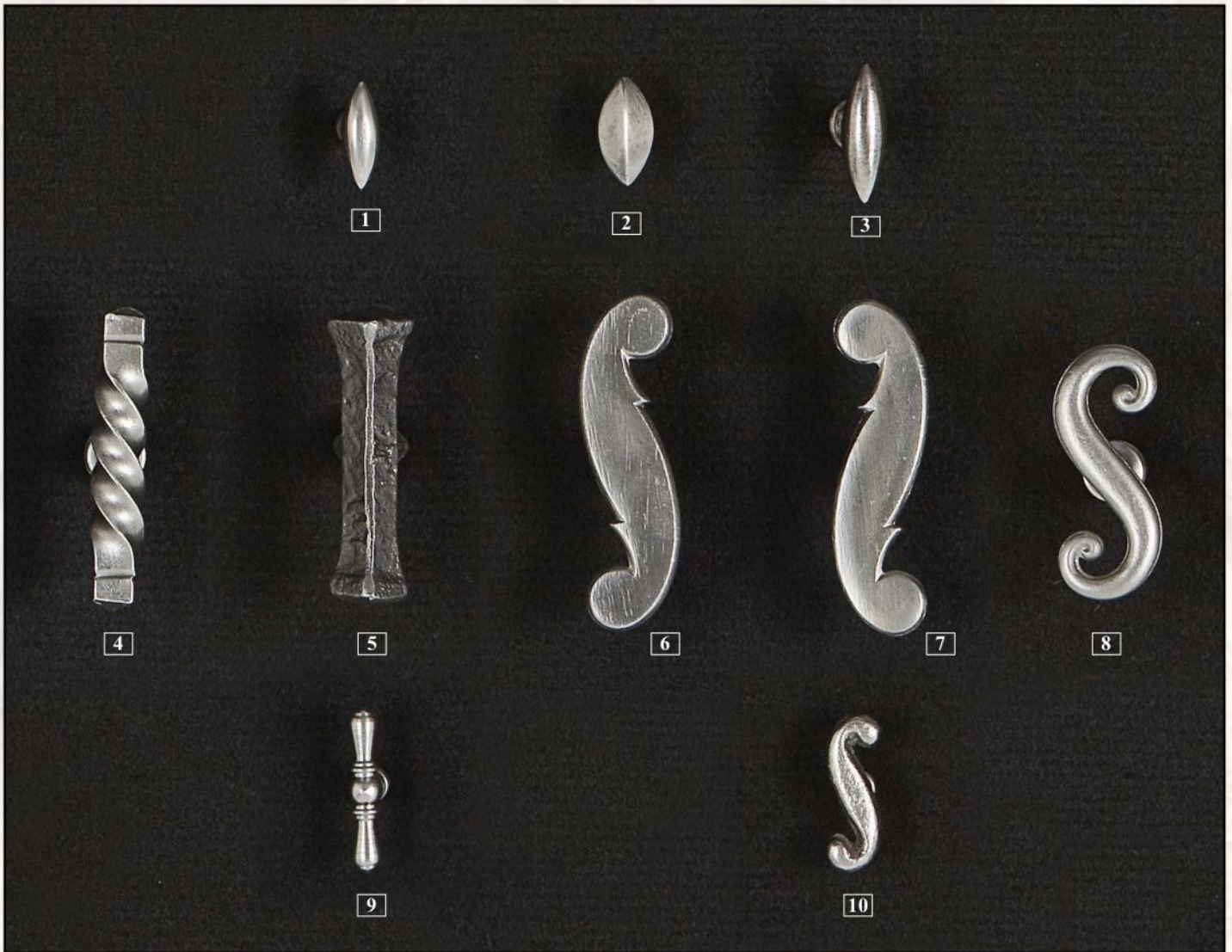

IRON		A	B	C
<b>1</b>	06.2084.0001	1-5/16"	1-5/16"	7/16"
<b>2</b>	06.1031.1	7/8"	1-3/8"	11/16"
<b>3</b>	06.2085.0001	1-3/8"	1-5/8"	1/2"
<b>4</b>	06.1536.0001	1-3/4"	3-1/2"	5/8"
<b>5</b>	06.3030.0001	2"	3-3/8"	1"
<b>6 left</b>	06.2030.0001	1-1/2"	3-7/8"	1-3/16"
<b>7 right</b>	06.2030.0001	1-1/2"	3-7/8"	1-3/16"
<b>8</b>	06.5252.0001	1-1/2"	3"	1-1/4"
<b>9</b>	06.9071.0001	7/8"	2"	3/8"
<b>10</b>	06.9072.0001	7/8"	1-7/8"	5/8"



# IRON KNOBS

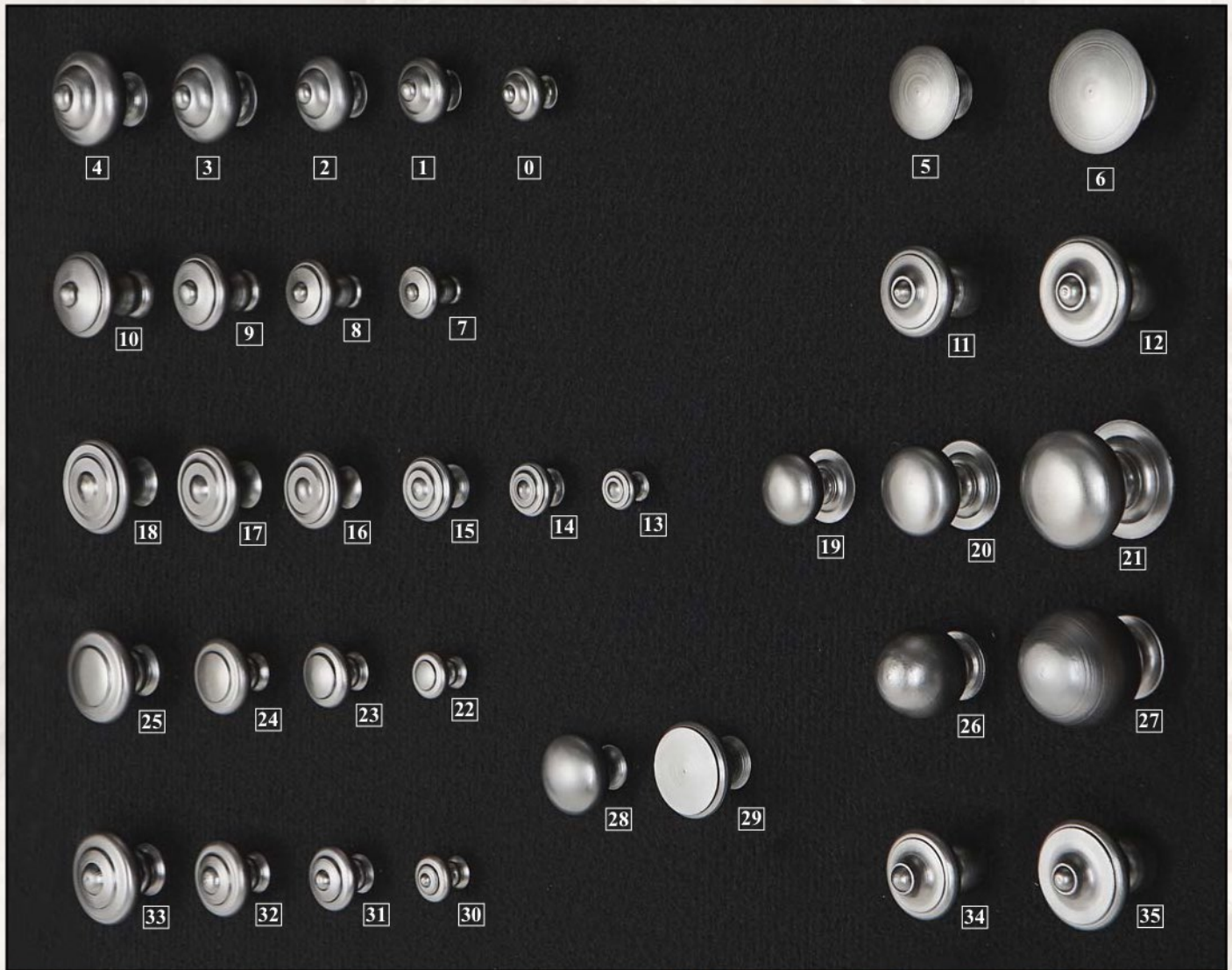

IRON		A	B
0	06.779.201	7/8"	3/4"
1	06.779.251	15/16"	1"
2	06.779.301	1-1/8"	1-3/16"
3	06.779.351	1-1/4"	1-3/8"
4	06.779.401	1-1/2"	1-1/2"
5	06.1284.301	3/4"	1-3/16"
6	06.1284.351	7/8"	1-1/2"
7	06.68.201	7/8"	3/4"
8	06.68.251	1-1/16"	1"
9	06.68.301	1-5/16"	1-3/16"
10	06.68.351	1-7/16"	1-3/8"
11	06.1285.301	1-5/16"	1-3/16"
12	06.1285.351	1-7/16"	1-3/8"
13	06.1538.151	9-16"	9/16"
14	06.1538.201	5/8"	3/4"
15	06.1538.251	13/16"	1"
16	06.1538.301	15/16"	1-3/16"
17	06.1538.351	1-1/8"	1-3/8"

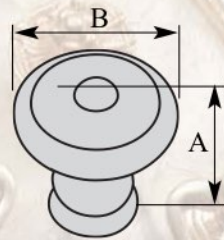

IRON		A	B
18	06.1538.401	1-1/4"	1-1/2"
19	06.0025.0251	1"	1"
20	06.25.301	1-3/16"	1-3/16"
21	06.25.381	1-7/16"	1-1/2"
22	06.23.181	3/4"	11/16"
23	06.23.251	13/16"	1"
24	06.23.301	1"	1-3/16"
25	06.23.381	1-3/16"	1-1/2"
26	06.29.301	1-7/16"	1-3/16"
27	06.29.381	1-3/4"	1-1/2"
28	06.33.301	1-1/8"	1-3/16"
29	06.2001.351	1"	1-3/8"
30	06.24.181	7/8"	11/16"
31	06.24.251	15/16"	1"
32	06.24.301	1-1/8"	1-3/16"
33	06.24.381	1-5/16"	1-1/2"
34	06.1286.301	1-1/2"	1-3/16"
35	06.1286.351	1-5/8"	1-3/8"

# BRASS KNOBS

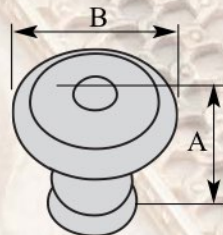

BRASS	A	B
37	9/16"	1/2"
38	5/8"	11/16"
39	3/4"	13/16"
40	13/16"	1"
41	15/16"	1-1/4"
42	1-1/16"	1-9/16"
43	3/4"	3/4"
44	13/16"	1"
45	15/16"	1-3/16"
46	1-1/8"	1-1/2"
47	1"	1"
48	1-3/16"	1-3/16"
49	1-1/2"	1-9/16"
50	1-7/16"	1-3/16"
51	1-13/16"	1-9/16"
52	3/4"	1"

BRASS	A	B
53	7/8"	1-3/16"
54	1-1/8"	1-1/2"
55	1"	1"
56	1-1/8"	1-3/16"
57	1-3/8"	1-3/8"
58	1"	1"
59	1-1/8"	1-3/16"
60	5/8"	7/8"
61	3/4"	1-1/8"
62	1"	1-5/16"
63	1-1/8"	1-1/2"
64	7/8"	3/4"
65	1-1/16"	1"
66	1-1/4"	1-3/16"
67	1-7/16"	1-3/8"



# BRASS KNOBS

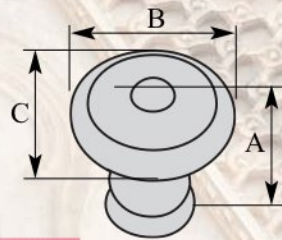

BRASS		A	B	C
<b>1</b>	06.0371.0252	1"	5/8"	1-1/16"
<b>2</b>	06.0371.0302	1-1/4"	13/16"	1-5/16"
<b>3</b>	06.0371.0352	1-3/8"	15/16"	1-1/2"
<b>4</b>	06.2001.302	13/16"	1-1/8"	
<b>5</b>	06.2001.352	15/16"	1-5/16"	
<b>6</b>	06.1031.2	1-1/4"	5/8"	1-3/16"
<b>7</b>	06.2084.0002	1-1/8"	7/16"	1-7/16"
<b>8</b>	06.0136.0402	1"	1-1/2"	
<b>9</b>	06.0146.0252	3/4"	1"	
<b>10</b>	06.0146.0302	7/8"	1-3/16"	
<b>11</b>	06.0146.0402	1"	1-1/2"	
<b>12</b>	06.0135.0302	7/8"	1-3/16"	
<b>13</b>	06.0779.0202	7/8"	3/4"	
<b>14</b>	06.0779.0252	15/16"	1"	
<b>15</b>	06.0779.0302	1-1/8"	1-3/16"	
<b>16</b>	06.0779.0352	1-5/16"	1-5/16"	
<b>17</b>	06.1284.122	1/2"	1/2"	
<b>NOT SHOWN</b>	06.1284.142	1/2"	9/16"	
<b>18</b>	06.1284.152	7/16"	5/8"	

BRASS		A	B
<b>19</b>	06.1284.182	9/16"	3/4"
<b>20</b>	06.1284.202	1/2"	13/16"
<b>21</b>	06.1284.252	11/16"	1"
<b>22</b>	06.1284.302	3/4"	1-3/16"
<b>23</b>	06.1284.352	7/8"	1-1/2"
<b>24</b>	06.1286.302	1-1/2"	1-3/16"
<b>25</b>	06.1285.302	1-5/16"	1-3/16"
<b>26</b>	06.1285.352	1-1/2"	1-3/8"
<b>27</b>	06.1538.152	9/16"	5/8"
<b>28</b>	06.1538.202	5/8"	13/16"
<b>29</b>	06.1538.252	13/16"	1"
<b>30</b>	06.1538.302	7/8"	1-3/16"
<b>31</b>	06.1538.352	1-1/8"	1-5/16"
<b>32</b>	06.1538.402	1-1/4"	1-1/2"
<b>33</b>	06.24.182	7/8"	11/16"
<b>34</b>	06.24.252	15/16"	1"
<b>35</b>	06.24.302	1-1/8"	1-3/16"
<b>36</b>	06.24.382	1-5/16"	1-1/2"

# BRASS KNOBS

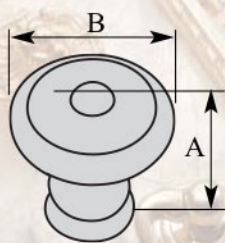

BRASS		A	B
<b>1</b>	06.63.302	11/16"	1-3/16"
<b>2</b>	06.63.352	3/4"	1-3/8"
<b>3</b>	06.63.402	13/16"	1-1/2"
<b>4</b>	06.63.452	13/16"	1-3/4"
<b>5</b>	06.63.502	13/16"	2"
<b>6</b>	06.440.42	3/4"	1-5/8"
<b>7</b>	06.440.52	1"	2"
<b>8</b>	06.8921.2	7/8"	1-5/8"
<b>9</b>	06.8928.2	7/8"	2"

BRASS		A	B
<b>10</b>	06.455.452	3/4"	1-3/4"
<b>11</b>	06.455.522	1-1/8"	2-1/8"
<b>12</b>	06.64.252	5/8"	1"
<b>13</b>	06.64.302	11/16"	1-3/16"
<b>14</b>	06.64.352	13/16"	1-7/16"
<b>15</b>	06.64.402	13/16"	1-5/8"
<b>16</b>	06.64.452	1"	1-3/4"
<b>17</b>	06.64.502	1"	2"

# BRASS KNOBS

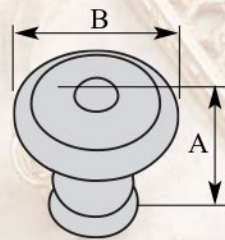

BRASS		A	B
<b>1</b>	06.1287.152	1/2"	9/16"
<b>2</b>	06.1287.202	3/4"	3/4"
<b>3</b>	06.1287.252	7/8"	1"
<b>4</b>	06.1287.302	7/8"	1-1/8"
<b>5</b>	06.1287.352	1-1/8"	1-3/8"
<b>6</b>	06.1287.402	1-7/16"	1-1/2"
<b>7</b>	06.1287.452	1-1/2"	1-3/4"
<b>8</b>	06.1289.152	1/2"	9/16"
<b>9</b>	06.1289.202	3/4"	3/4"
<b>10</b>	06.1289.252	7/8"	1"
<b>11</b>	06.1289.302	7/8"	1-1/8"
<b>12</b>	06.1289.352	1-1/8"	1-3/8"

BRASS		A	B
<b>13</b>	06.1289.452	1-1/2"	1-3/4"
<b>14</b>	06.2000.152	1/2"	5/8"
<b>15</b>	06.2000.202	11/16"	13/16"
<b>16</b>	06.2000.252	3/4"	1"
<b>17</b>	06.2000.302	1"	1-1/8"
<b>18</b>	06.2000.352	1-1/8"	1-3/8"
<b>19</b>	06.2000.402	1-1/4"	1-1/2"
<b>20</b>	06.62.202	5/8"	3/4"
<b>21</b>	06.62.252	3/4"	1"
<b>22</b>	06.62.302	7/8"	1-3/16"
<b>23</b>	06.62.352	1"	1-3/8"
<b>24</b>	06.62.402	1-1/2"	1-1/2"

# LOST WAX BRONZE KNOBS

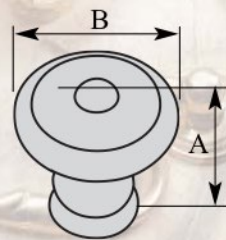
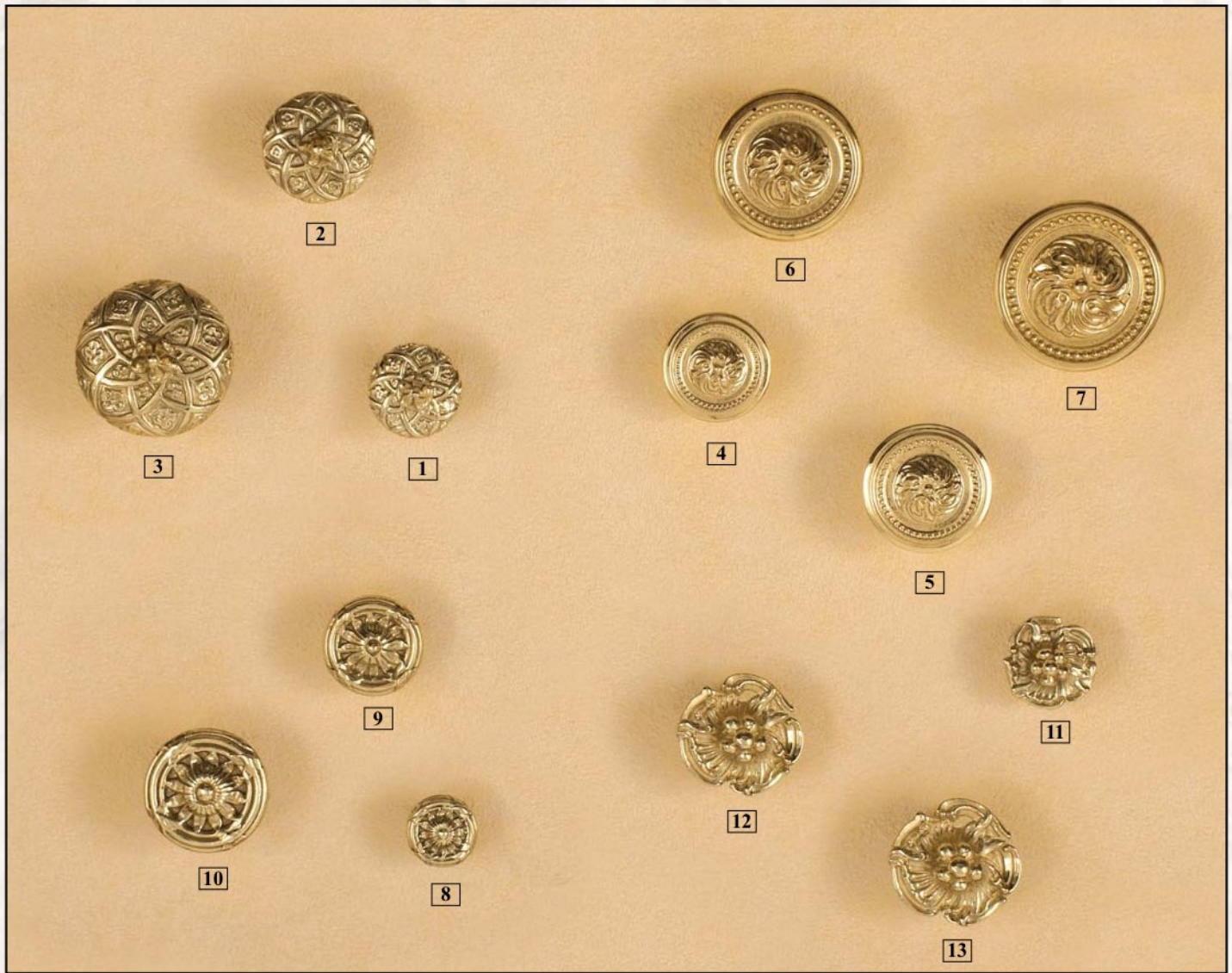

BRONZE		A	B
<b>1</b>	06.1612.0222	1"	7/8"
<b>2</b>	06.1612.0272	1-3/16"	1-1/16"
<b>3</b>	06.1612.0352	1-3/4"	1-3/8"
<b>4</b>	06.3638.0252	13/16"	1"
<b>5</b>	06.3638.0302	15/16"	1-1/4"
<b>6</b>	06.3638.0352	1"	1-3/8"
<b>7</b>	06.3638.0402	1-1/8"	1-5/8"

BRONZE		A	B
<b>8</b>	06.1992.0182	5/8"	5/8"
<b>9</b>	06.1992.0242	3/4"	15/16"
<b>10</b>	06.1992.0302	7/8"	1-3/16"
<b>11</b>	06.0585.0232	7/8"	7/8"
<b>12</b>	06.0585.0292	1-3/16"	1-1/16"
<b>13</b>	06.0585.0322	1-1/4"	1-3/16"



# SAND CAST BRASS KNOBS

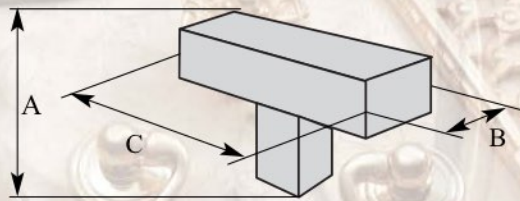

BRASS	A	B	C
<b>1</b> 06.415.2	1-1/8"	11/16"	1-7/8"
<b>2</b> 06.0444.2	1-11/16	1-3/16"	2-1/4"
<b>3</b> 06.445	1-1/4"	5/8"	1-3/4"
<b>4</b> 06.0614.2	1-7/8	1"	2-1/2"
<b>5</b> 06.1054.0002	1"	3/4"	1-7/8"
<b>6</b> 06.615.2	1-1/16"	5/8"	1-5/16"
<b>7</b> 06.425.2	1-1/8"	15/16"	1-3/8"
<b>8</b> 06.515.2	7/8"	1"	1-3/8"
<b>9</b> 06.315.2	1-1/8"	13/16"	1-9/16"

BRASS	A	B	C
<b>10</b> 06.3708.0002	1"	13/16"	1-5/16"
<b>11</b> 06.725.2	1"	5/8"	1-3/4"
<b>12</b> 06.575	7/8"	5/8"	1-3/4"
<b>13</b> 06.0293.0002	7/8"	5/8"	5/8"
<b>14</b> 06.715.2	7/8"	3/4"	1-5/16"
<b>15</b> 06.7.402	1"	9/16"	1-7/16"
<b>16</b> 06.7.452	1-1/4"	3/4"	1-3/4"
<b>17</b> 06.7.602	1-9/16"	7/8"	3"
<b>18</b> 06.3570.2	15/16"	7/8"	1-3/16"

# BRASS PENDANTS

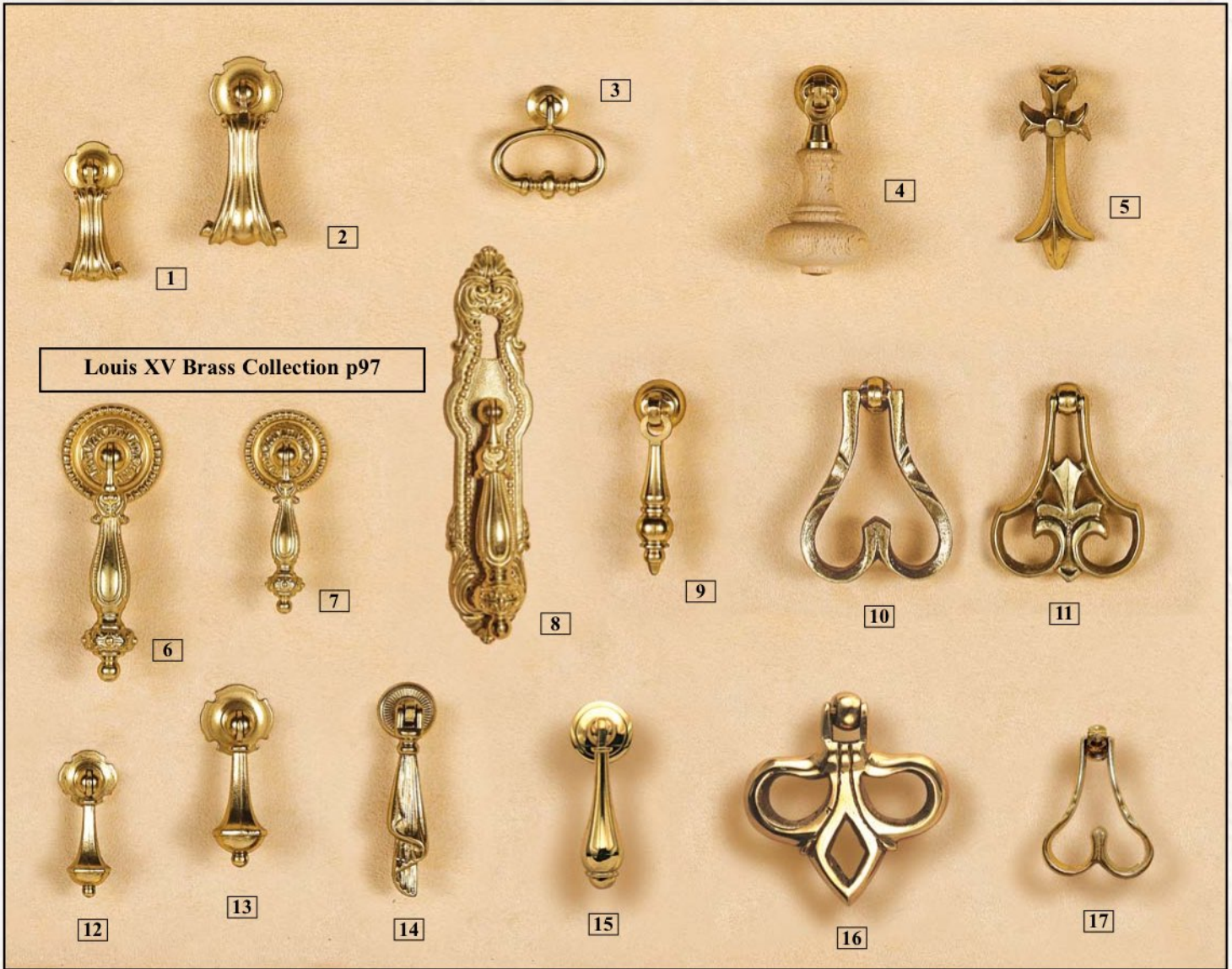

BRASS	A	B	C
<b>1</b> 07.0475.0402	2"	11/16"	1/2"
<b>2</b> 07.0475.0502	2-1/2"	1-3/16"	5/8"
<b>3</b> 07.5300.0002	1-9/16"	1-9/16"	5/8"
<b>4</b> 07.68.2	2-3/4"	1-3/8"	15/16"
<b>5</b> 07.1070.2	2-13/16"	1-3/16"	7/8"
<b>6</b> 07.0424.0702	3-3/4"	1-5/16"	1"
<b>7</b> 07.0424.0502	2-5/8"	1-1/8"	7/8"
<b>8</b> 07.0425.2	5-3/8"	1-1/4"	3/4"
<b>9</b> 07.0475.0402	2"	11/16"	1/2"

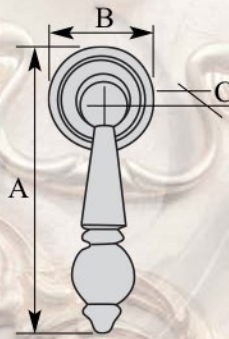

BRASS	A	B	C
<b>10</b> 07.0597.0002	2-5/8"	2-1/16"	11/16"
<b>11</b> 07.1506.2	2-5/8"	2-1/8"	5/8"
<b>12</b> 07.42.42	2"	7/8"	9/16"
<b>13</b> 07.42.52	2-1/4"	1"	11/16"
<b>14</b> 07.1197.0702	2-5/8"	13/16"	5/8"
<b>15</b> 07.5524.2	2-3/8"	7/8"	3/4"
<b>16</b> 05.3139.2	2-3/4"	2-1/2"	3/4"
<b>17</b> 07.597.2	1-7/8"	1-1/2"	1/2"

# IRON PENDANTS



# 4 rosette  
12.1515.1  
see page 83  
for size

Rosettes on pendants are optional

IRON	A	B	C
<b>1</b> 07.512.1	3"	1-9/16"	9/16"
<b>2</b> 07.50.651	3-1/2"	1/2"	1/2"
<b>3</b> 07.0050.0901	3-3/4"	5/8"	5/8"
<b>4</b> 07.1595.0001	3"	3/4"	5/8"
<b>5</b> 07.1597.1	3-1/4"	11/16"	9/16"
<b>6</b> 07.597.1	2"	1-1/2"	1/2"
<b>7</b> 07.1506.1	2-3/4"	2-1/8"	5/8"

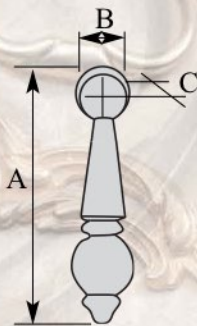

IRON	A	B	C
<b>8</b> 07.38.1	2-11/16"	3/4"	13/16"
<b>9</b> 07.1070.1	2-7/8"	1-3/16"	7/8"
<b>10</b> 07.1555.41	1-3/4"	1-9/16"	5/8"
<b>11</b> 07.1555.61	2-11/16"	2"	5/8"
<b>12</b> 07.68.1	2-3/4"	1-3/8"	15/16"
<b>13</b> 05.3139.1	2-3/4"	2-1/2"	3/4"
<b>14</b> 07.0597.0001	2-3/4"	2"	5/8"

# IRON ESCUTCHEONS

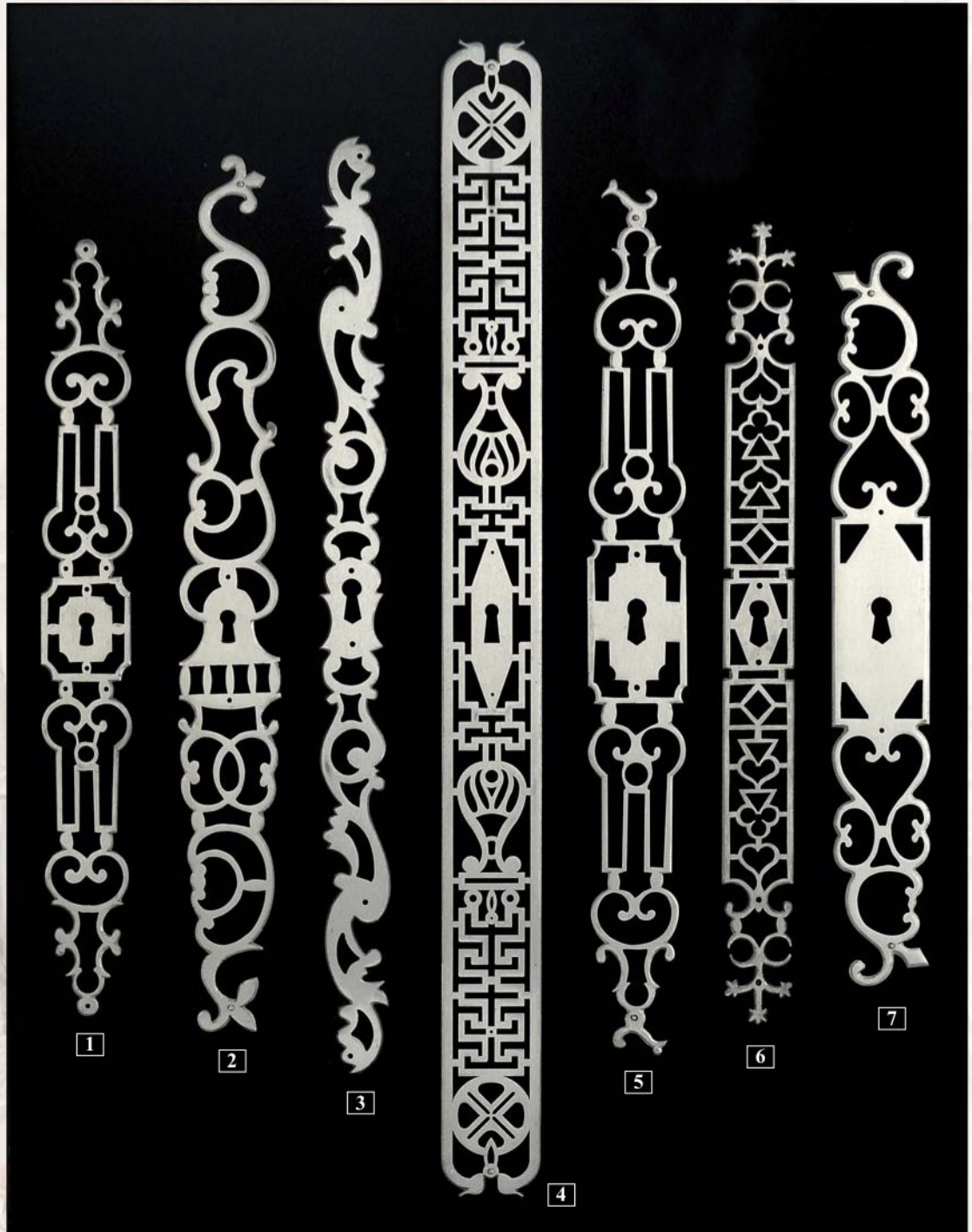
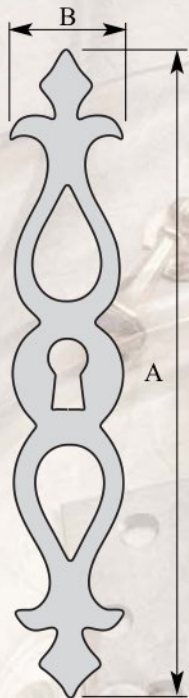

**NOTE:** Above escutcheons are sold as pairs.

IRON		A	B
<b>1</b>	08.501	15-7/8"	1-7/8"
<b>2</b>	08.491	17-13/16"	2-1/16"
<b>3</b>	08.521	19-1/8"	1-3/8"
<b>4</b>	08.0084.5951	23-3/8"	2-1/16"

IRON		A	B
<b>5</b>	08.451	17-7/8"	2-1/16"
<b>6</b>	08.461	16-3/8"	1-1/2"
<b>7</b>	08.511	15-1/8"	2-1/16"



# IRON ESCUTCHEONS

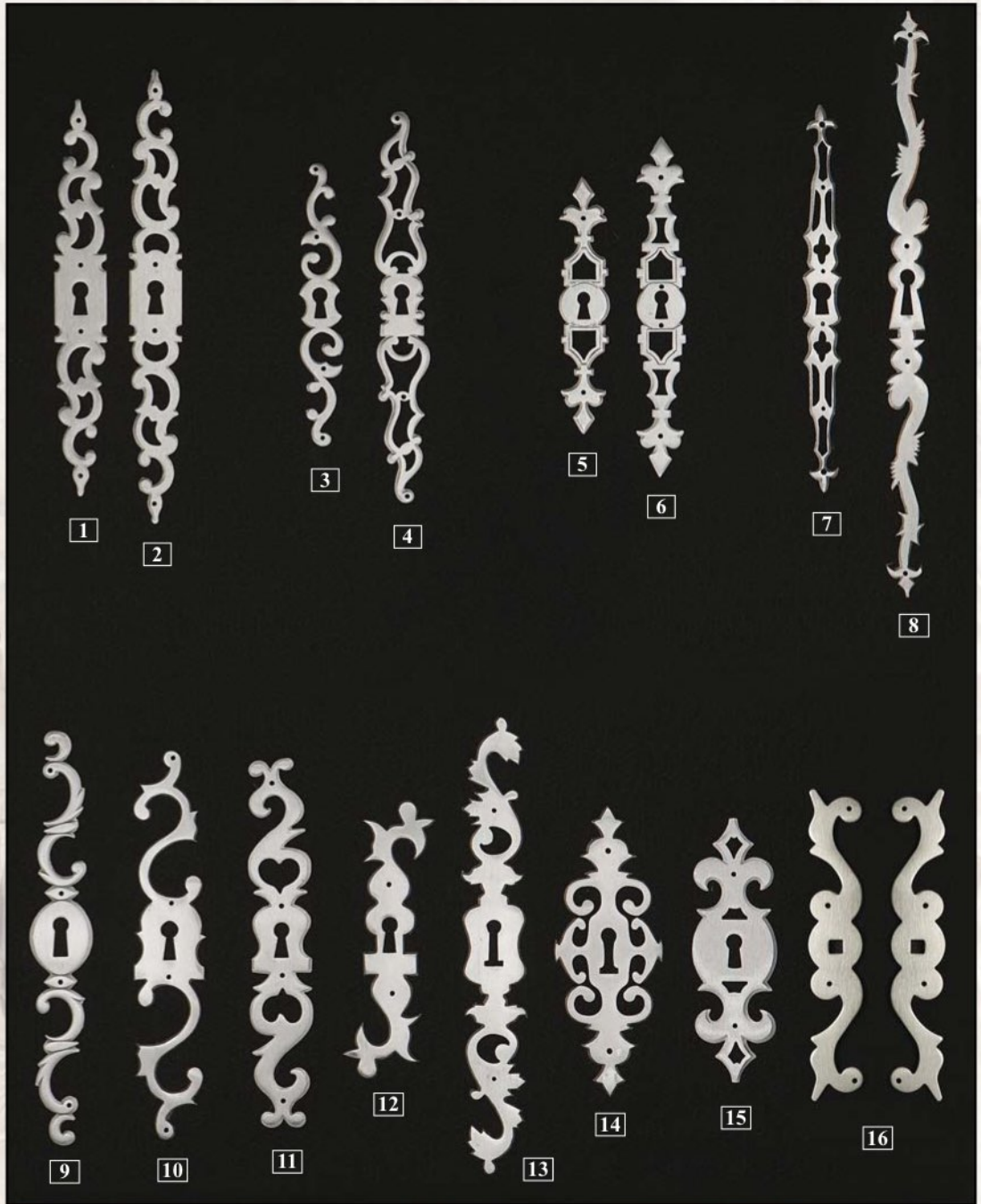
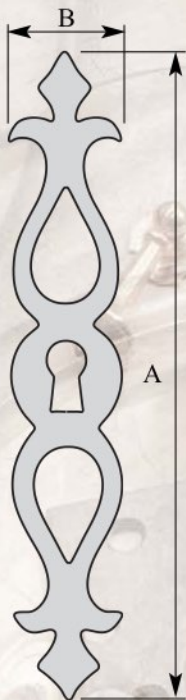

**NOTE:** Sold as pairs.

IRON		A	B
<b>1</b>	08.81.191	7-7/8"	1-1/16"
<b>2</b>	08.81.231	9"	1-1/16"
<b>3</b>	08.9880.1	5-5/8"	7/8"
<b>4</b>	08.9881.1	7-3/4"	1-1/16"
<b>5</b>	08.9876.131	5-1/8"	1-1/16"
<b>6</b>	08.9876.171	6-3/4"	1"
<b>7</b>	08.541	7-3/4"	13/16"
<b>8</b>	08.0041.0001	12"	3/4"

IRON		A	B
<b>9</b>	08.9000.1	8-1/8"	1-1/4"
<b>10</b>	08.0064.0001	7-3/4"	1-3/8"
<b>11</b>	08.9878.1	7-5/16"	1-1/4"
<b>12</b>	08.0083.0001	5-5/8"	1-1/2"
<b>13</b>	08.0042.0001	9"	1-1/4"
<b>14</b>	08.9810.0001	5-7/8"	2-1/8"
<b>15</b>	08.5166.1301	5-3/8"	1-3/4"
<b>16</b>	08.606.1 L/R	6"	1-1/16"

# IRON ESCUTCHEONS

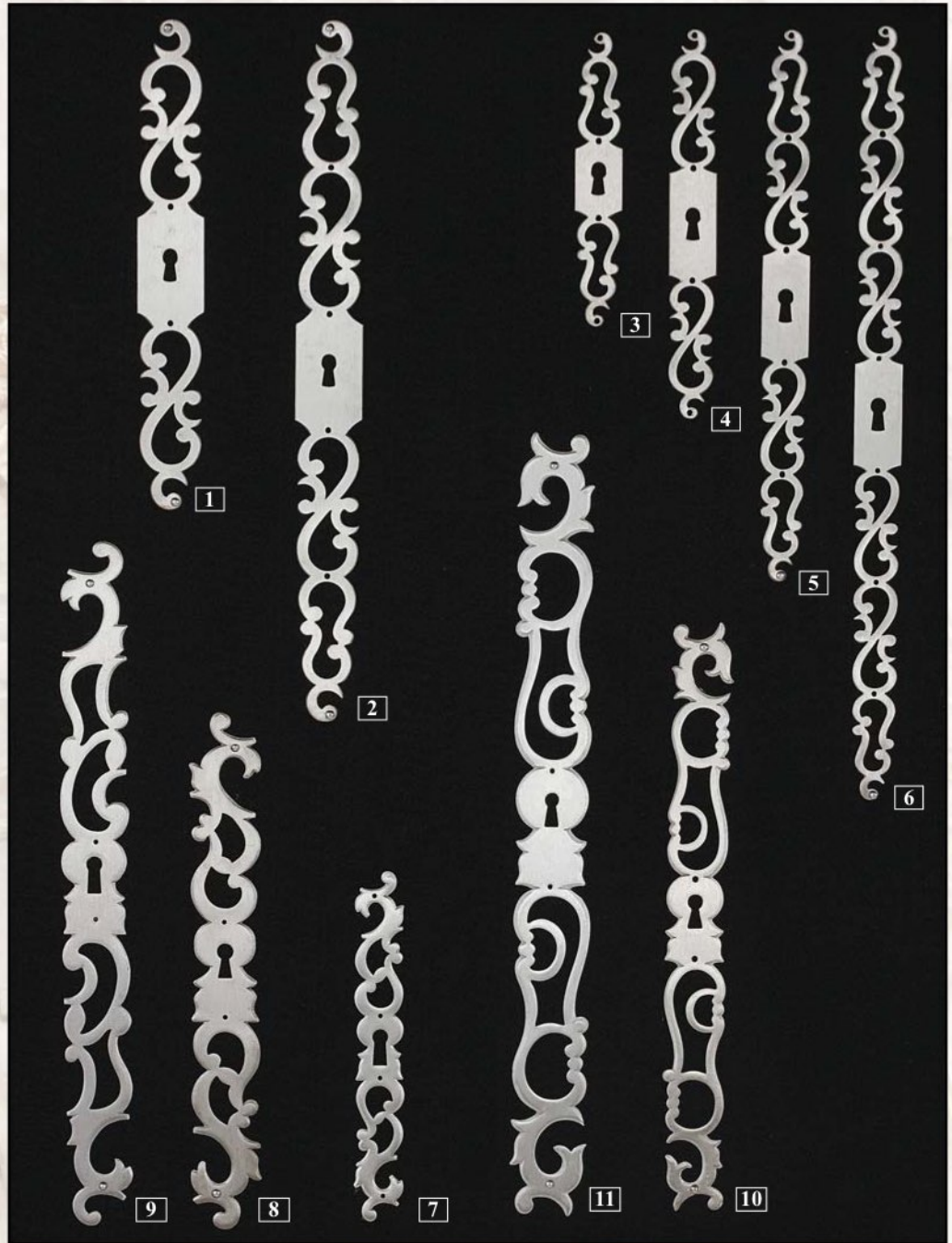

**NOTE:** Sold as pairs.

IRON		A	B
<b>1</b>	08.6.0251	10"	1-3/8"
<b>2</b>	08.6.0401	14-1/4"	1-3/8"
<b>3</b>	08.6.151	6"	1"
<b>4</b>	08.6.201	8"	1"
<b>5</b>	08.6.281	11-1/4"	1"
<b>6</b>	08.6.361	15-7/8"	1"

IRON		A	B
<b>7</b>	08.9879.181	7-1/4"	1"
<b>8</b>	08.9879.261	10-3/4"	1-3/8"
<b>9</b>	08.9879.361	14-3/16"	1-3/8"
<b>10</b>	08.9899.31	12-1/4"	1-1/8"
<b>11</b>	08.9899.41	16-1/8"	1-1/2"



# IRON ESCUTCHEONS

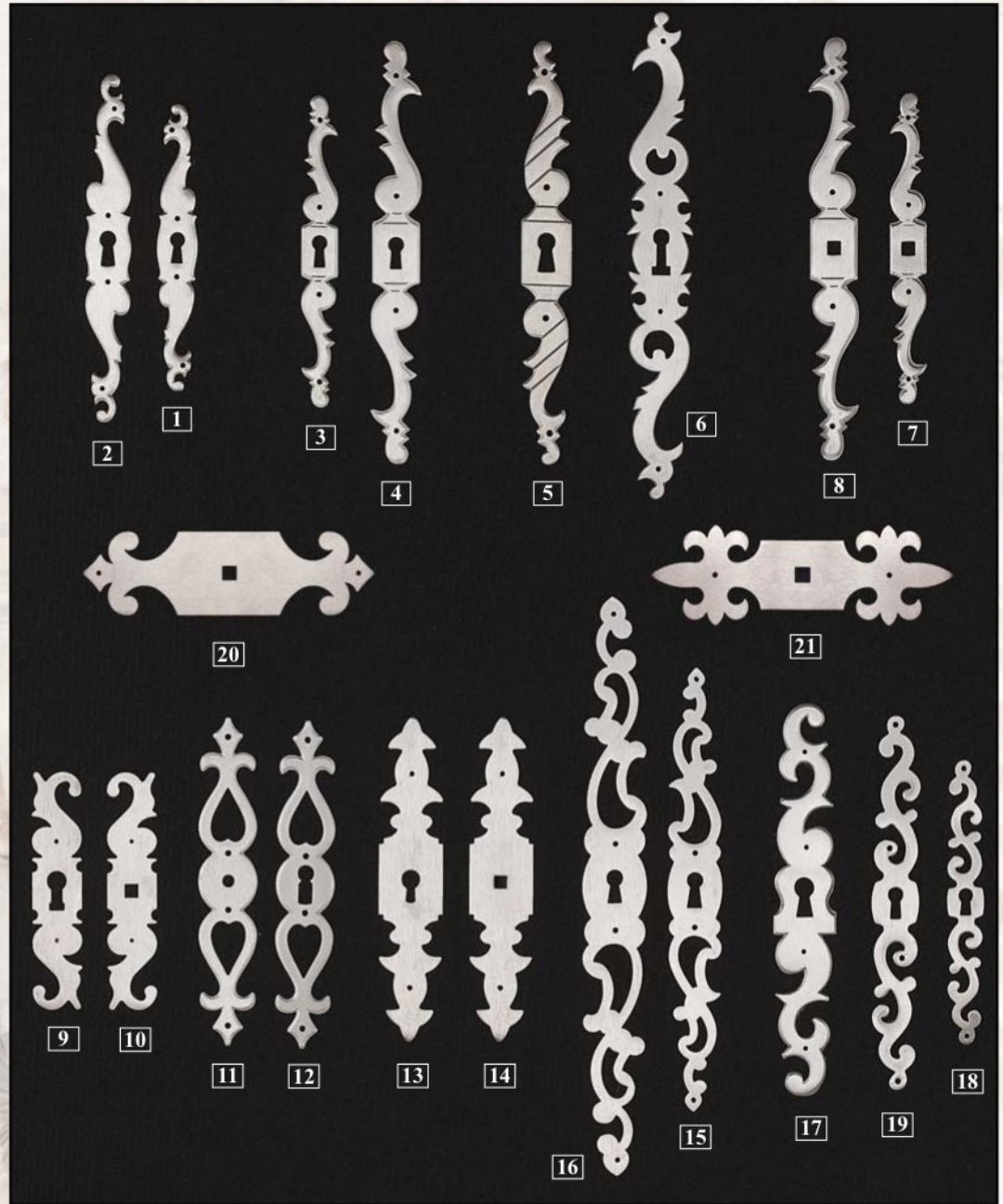
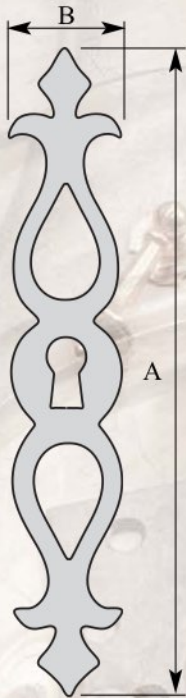

**NOTE:** Sold as pairs.

IRON		A	B
<b>1</b>	08.0066.1401	5-1/2"	3/4"
<b>2</b>	08.0066.1701	6-3/4"	7/8"
<b>3</b>	08.117.141.18	5-15/16"	11/16"
<b>4</b>	08.117.201.18	8-1/16"	7/8"
<b>5</b>	08.1257.1	8"	1"
<b>6</b>	08.551.1	9"	1-1/4"
<b>7</b>	08.117.141	5-15/16"	11/16"
<b>8</b>	08.117.201	8-1/16"	7/8"
<b>9</b>	08.1277.18	4-1/2"	1"
<b>10</b>	08.1277.1	4-1/2"	1"

IRON		A	B
<b>11</b>	08.9877.0001	6-3/8"	1-1/8"
<b>12</b>	08.9877.18	6-3/8"	1-1/8"
<b>13</b>	08.240.18	6-3/4"	1-1/4"
<b>14</b>	08.240.1	6-3/4"	1-1/4"
<b>15</b>	08.2053.201	8-1/2"	1-1/16"
<b>16</b>	08.2053.281	11"	1-1/4"
<b>17</b>	08.1260.18	7-1/2"	1"
<b>18</b>	08.9.141.18	5-1/2"	3/4"
<b>19</b>	08.9.201.18	7-3/16"	15/16"
<b>20</b>	05.3140.771	5-1/2"	1-5/8"
<b>21</b>	05.3139.771	5-3/8"	1-3/4"

# IRON ESCUTCHEONS

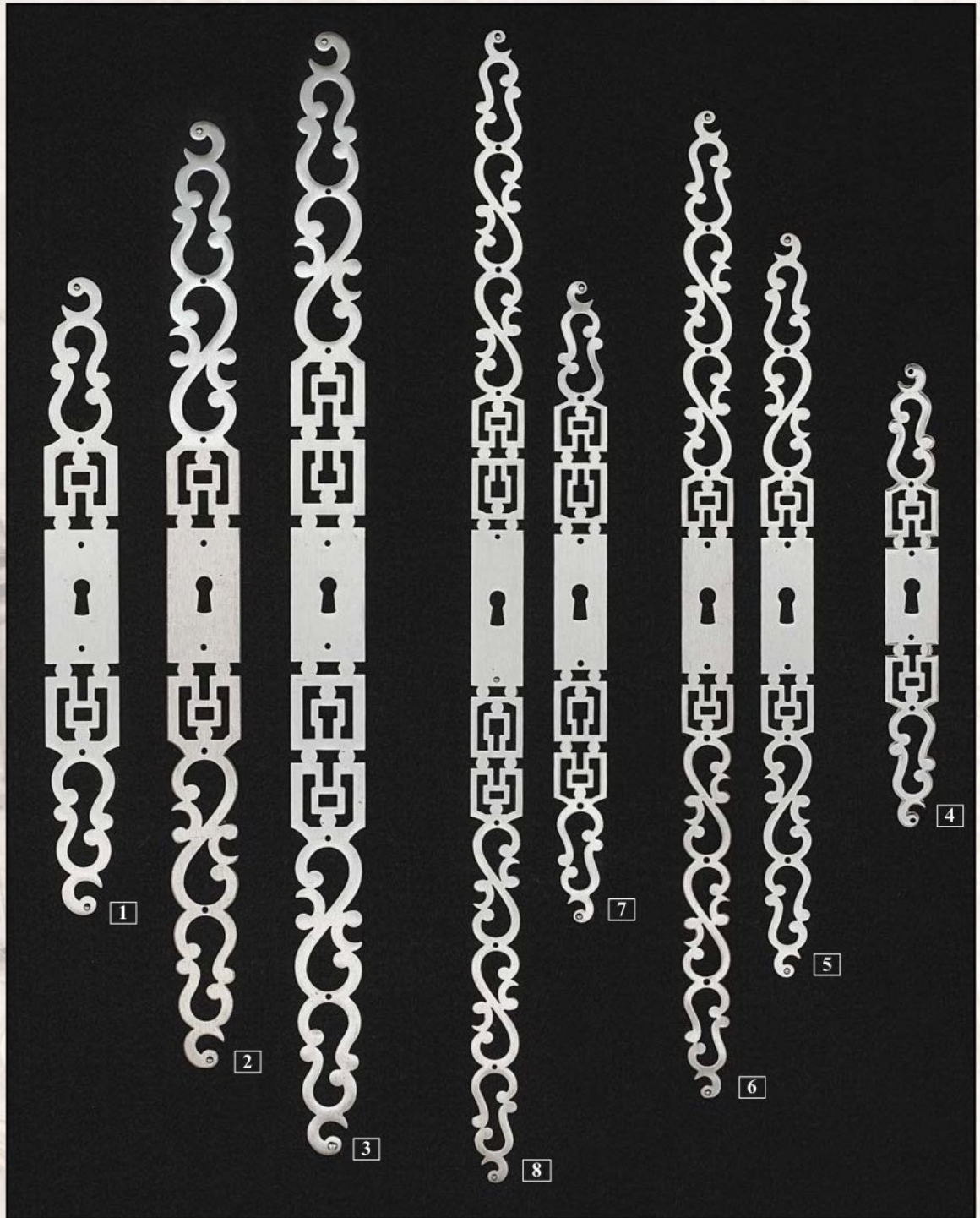
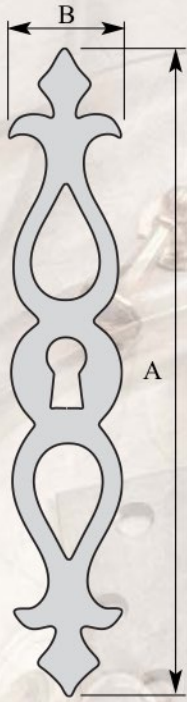

**NOTE:** Sold as pairs.

IRON		A	B
<b>1</b>	08.5.0301	11-7/8"	1-3/8"
<b>2</b>	08.5.0451	17-3/4"	1-3/8"
<b>3</b>	08.5.0531	21"	1-3/8"
<b>4</b>	08.5.221	8-3/4"	1"

IRON		A	B
<b>5</b>	08.5.351	14"	1"
<b>6</b>	08.5.471	18-1/2"	1"
<b>7</b>	08.5.301	12"	1"
<b>8</b>	08.5.541	21-5/8"	1"



# IRON ESCUTCHEONS

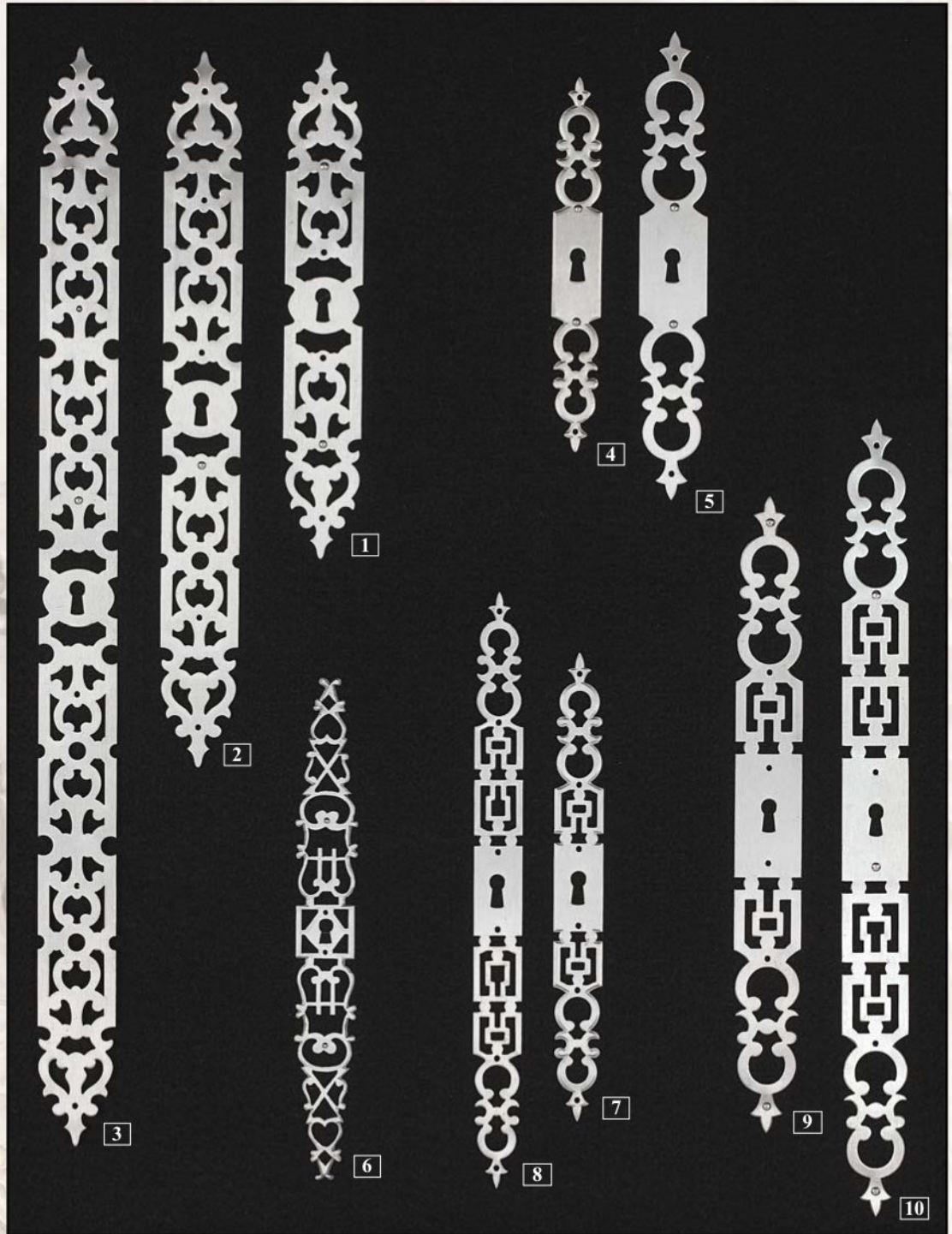
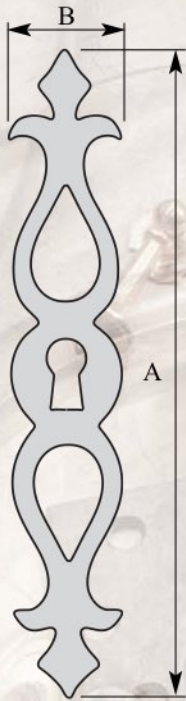

**NOTE:** Sold as pairs.

IRON		A	B
<b>1</b>	08.2044.261	10-1/4"	1-5/8"
<b>2</b>	08.2044.371	14-1/2"	1-5/8"
<b>3</b>	08.2044.561	22-1/4"	1-5/8"
<b>5</b>	08.4.191	7-5/8"	1"
	08.4.0241	9-1/2"	1-3/8"

IRON		A	B
<b>6</b>	08.561	10-3/16"	1-1/4"
<b>7</b>	08.4.241	9-1/2"	1"
<b>8</b>	08.4.311	12-1/4"	1"
<b>9</b>	08.4.0331	13"	1-3/8"
<b>10</b>	08.4.0411	16-1/4"	1-3/8"

# BRASS ESCUTCHEONS

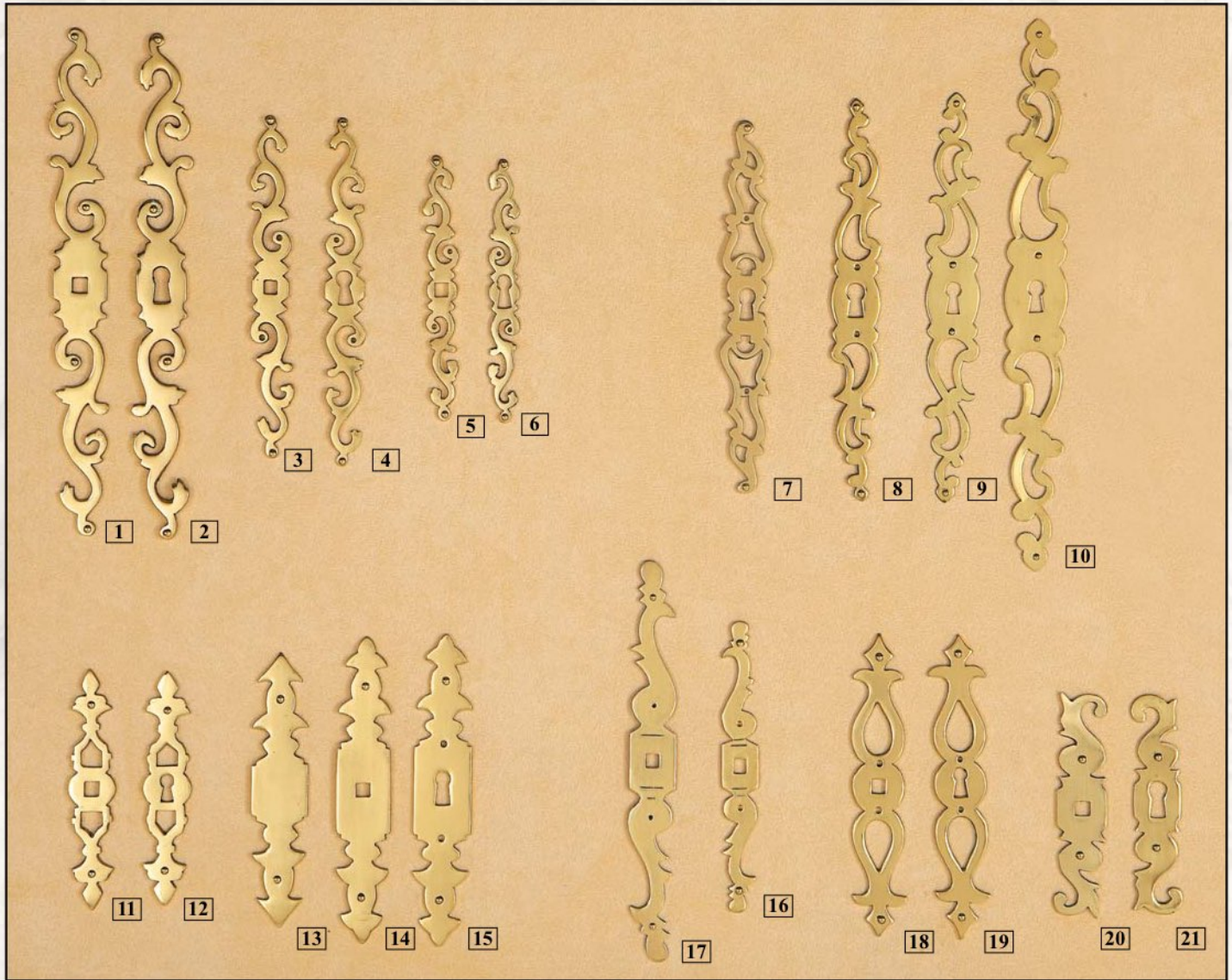

**NOTE:** Sold as pairs.

BRASS	A	B
<b>1</b> 08.9.2652	10-1/2"	1-1/8"
<b>2</b> 08.9.265.28	10-1/2"	1-1/8"
<b>3</b> 08.9.1802	7-1/4"	13/16"
<b>4</b> 08.9.180.28	7-1/4"	13/16"
<b>5</b> 08.9.132.2	5-1/2"	5/8"
<b>6</b> 08.9.132.28	5-1/2"	5/8"
<b>7</b> 08.9881.2	7-3/4"	1"
<b>8</b> 08.2053.202.5	8-1/8"	1"
<b>9</b> 08.2053.202	8-1/2"	1-1/16"
<b>10</b> 08.2053.282	11"	1-1/4"
<b>11</b> 08.9876.133	4-3/4"	1"



BRASS	A	B
<b>12</b> 08.9876.132	4-3/4"	1"
<b>13</b> 08.240.2	5-5/8"	1-3/16"
<b>14</b> 08.240.2.5	6-1/4"	1-1/4"
<b>15</b> 08.240.28	6-1/4"	1-3/16"
<b>16</b> 08.117.142	5-7/8"	3/4"
<b>17</b> 08.117.202	8"	1"
<b>18</b> 08.9877.2.5	6-1/8"	1-1/16"
<b>19</b> 08.9877.28	6-1/8"	1-1/16"
<b>20</b> 08.1277.2	4-1/2"	15/16"
<b>21</b> 08.1277.28	4-1/2"	1"



# BRASS ESCUTCHEONS

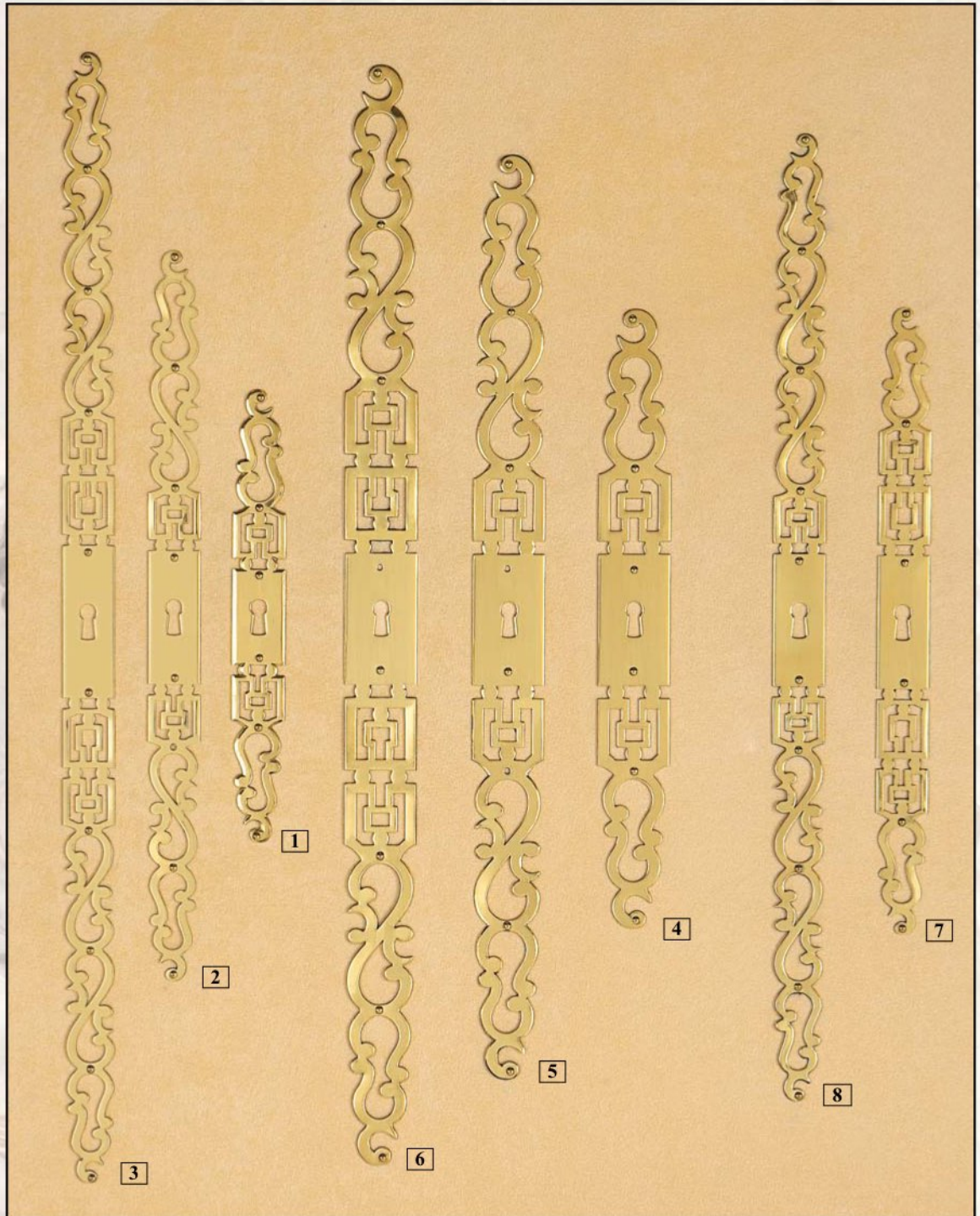
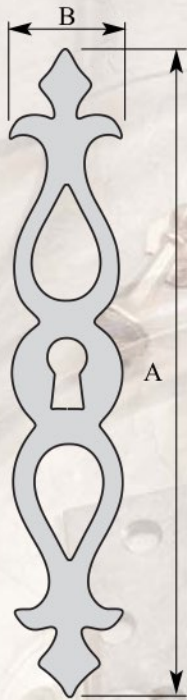

**NOTE:** Sold as pairs.

BRASS		A	B
<b>1</b>	08.5.222	8-3/4"	1"
<b>2</b>	08.5.352	14"	1"
<b>3</b>	08.5.472	18-1/2"	1"
<b>4</b>	08.5.0302	11-7/8"	1-3/8"

BRASS		A	B
<b>5</b>	08.5.0452	17-3/4"	1-3/8"
<b>6</b>	08.5.0532	21"	1-3/8"
<b>7</b>	08.5.302	12"	1"
<b>8</b>	08.5.542	21-5/8"	1"

# BRASS ESCUTCHEONS

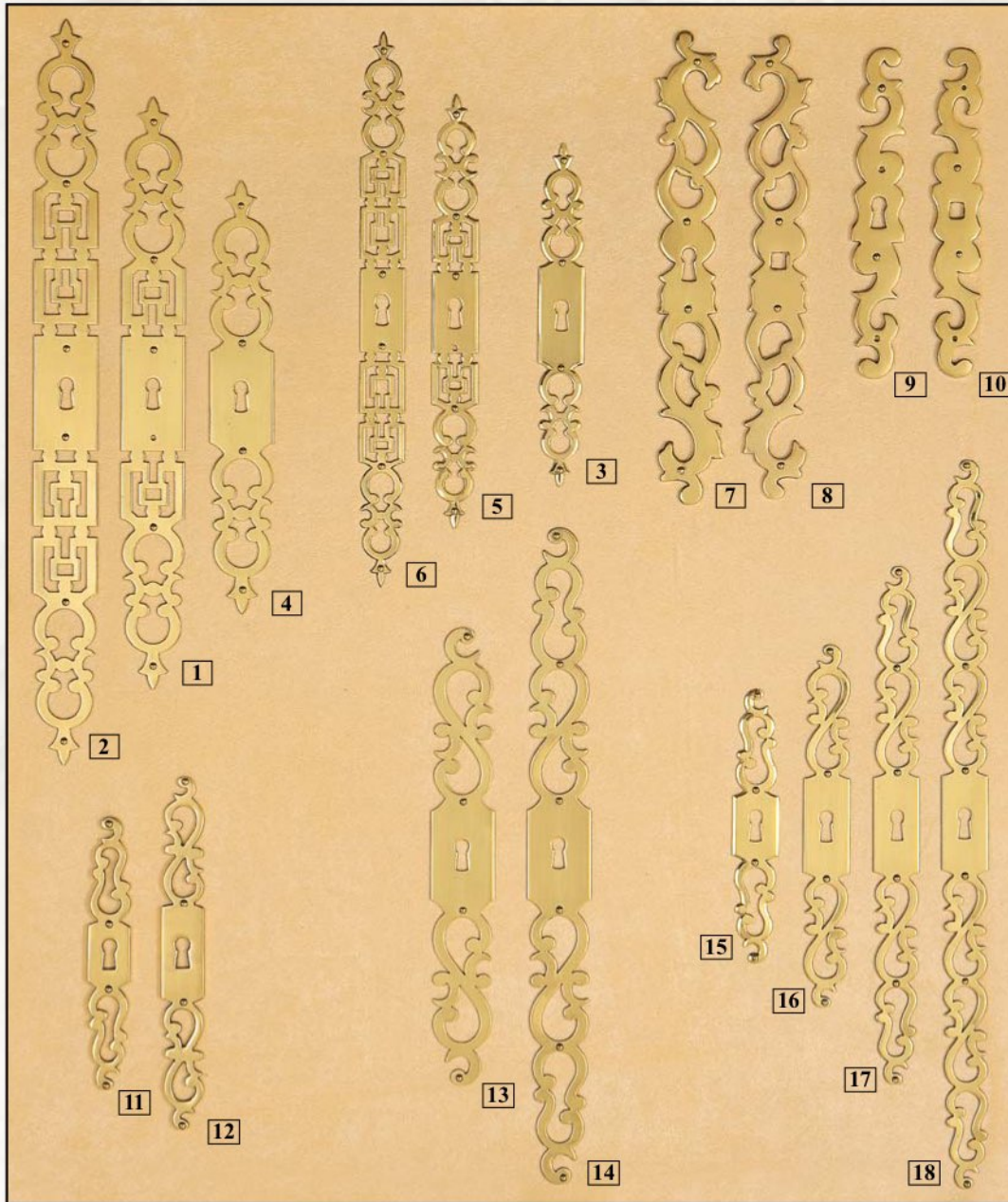

**NOTE:** Sold as pairs.

BRASS		A	B
<b>1</b>	08.4.0332	13"	1-3/8"
<b>2</b>	08.4.0412	16-1/4"	1-3/8"
<b>3</b>	08.4.192	7-5/8"	1"
<b>4</b>	08.4.0242	9-1/2"	1-3/8"
<b>5</b>	08.4.242	9-1/2"	1"
<b>6</b>	08.4.312	12-1/4"	1"
<b>7</b>	08.9879.262	10-1/4"	1-1/4"
<b>8</b>	08.9879.263	10-1/4"	1-1/4"
<b>9</b>	08.1260.28	7-3/16"	1-3/16"

BRASS		A	B
<b>10</b>	08.1260.2	7-3/16"	1-3/16"
<b>11</b>	08.6.152.5	6"	1"
<b>12</b>	08.6.202.5	8"	1"
<b>13</b>	08.6.0252	10"	1-3/8"
<b>14</b>	08.6.0402	14-1/4"	1-3/8"
<b>15</b>	08.6.152	6"	1"
<b>16</b>	08.6.202	8"	1"
<b>17</b>	08.6.282	11-1/4"	1"
<b>18</b>	08.6.362	15-7/8"	1"



# BRASS ESCUTCHEONS

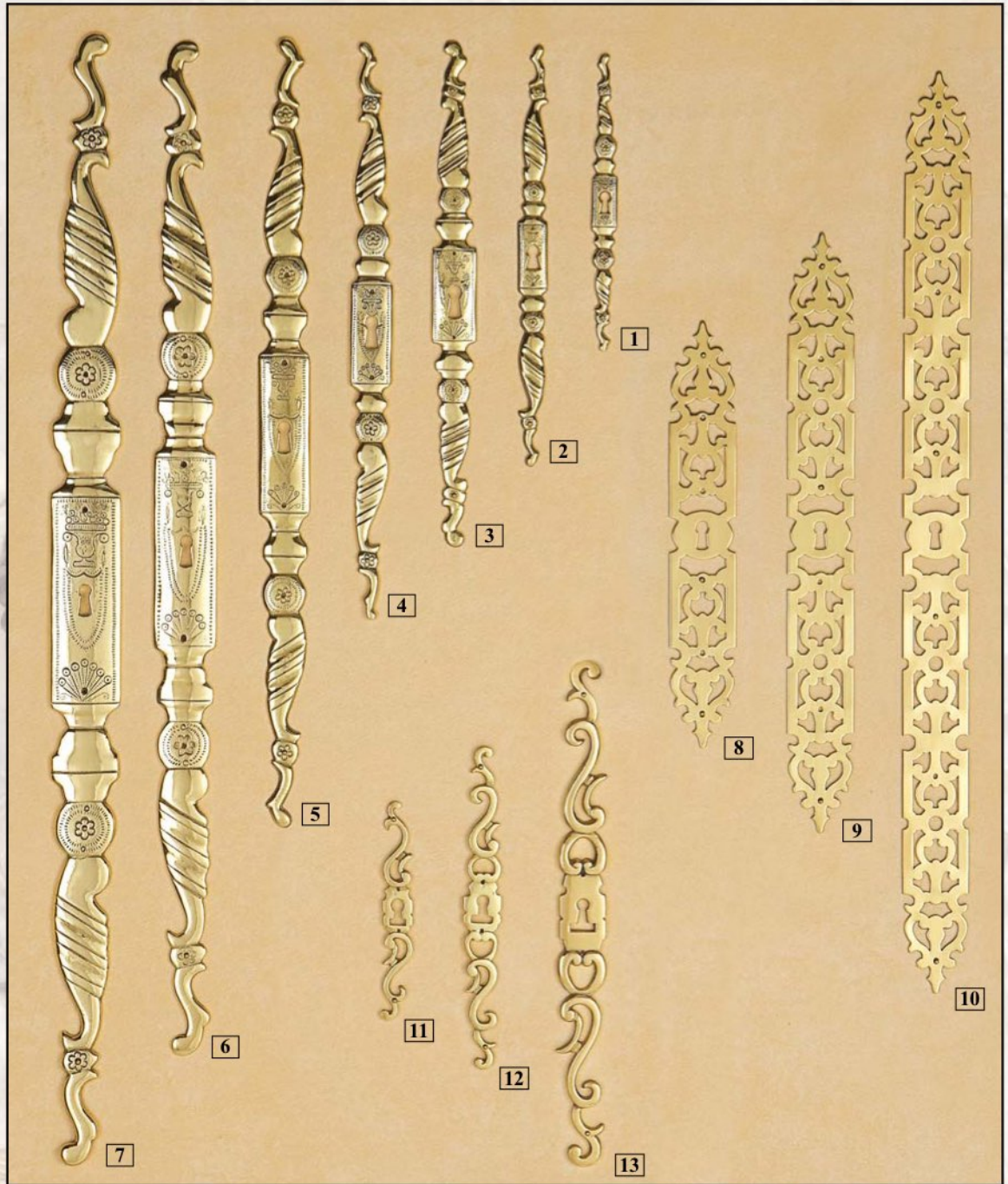
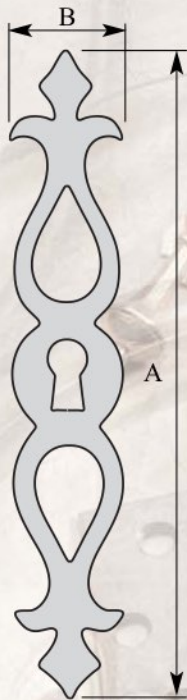

**NOTE:** Sold as pairs.

BRASS		A	B
<b>1</b>	08.3541.182	7-1/8"	5/8"
<b>2</b>	08.3541.262	10-1/4"	3/4"
<b>3</b>	08.3541.312	12-1/8"	1-1/16"
<b>4</b>	08.3541.362	14"	1-1/16"
<b>5</b>	08.3541.482	19"	1-1/4"
<b>6</b>	08.3541.612	24-1/4"	1-1/2"
<b>7</b>	08.3541.682	27-1/4"	1-3/4"

BRASS		A	B
<b>8</b>	08.2044.262	10-1/4"	1-5/8"
<b>9</b>	08.2044.372	14-1/2"	1-5/8"
<b>10</b>	08.2044.562	22-1/4"	1-5/8"
<b>11</b>	08.488.135	5-1/4"	3/4"
<b>12</b>	08.488.200	7-5/8"	7/8"
<b>13</b>	08.488.310	12-1/4"	1-1/8"

# BRASS ESCUTCHEONS

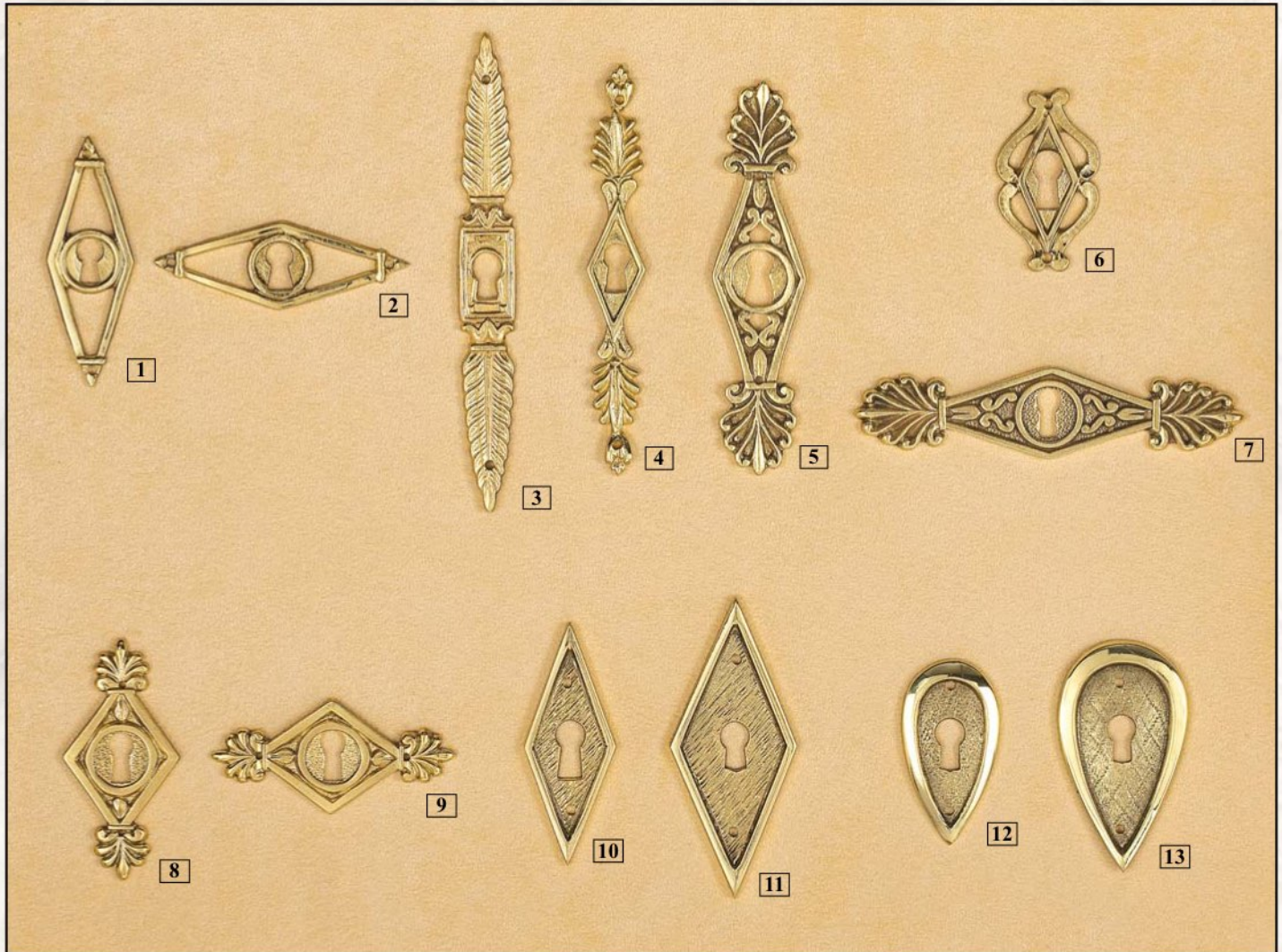

**NOTE:** Some escutcheons are sold as pairs.

**BRASS**

		A	B
<b>1</b>	09.1161.0652	2-5/8"	7/8"
<b>2</b>	09.1161.0222	7/8"	2-5/8"
<b>3</b>	08.204.2	5-1/16"	5/8"
<b>4</b>	09.696	4-1/4"	5/8"
<b>5</b>	08.219.105	4-3/16"	1-1/16"
<b>6</b>	09.101	1-15/16"	1-1/8"
<b>7</b>	08.218.109	1-1/16"	4-3/16"
<b>8</b>	08.219.69	2-9/16"	1-1/4"
<b>9</b>	08.218.69	1-1/4"	2-9/16"
<b>10</b>	09.521.62	2-5/8"	1"
<b>11</b>	09.521.82	3-1/4"	1-3/8"
<b>12</b>	09.551.52	2"	1-1/16"
<b>13</b>	09.551.62	2-1/2"	1-3/8"

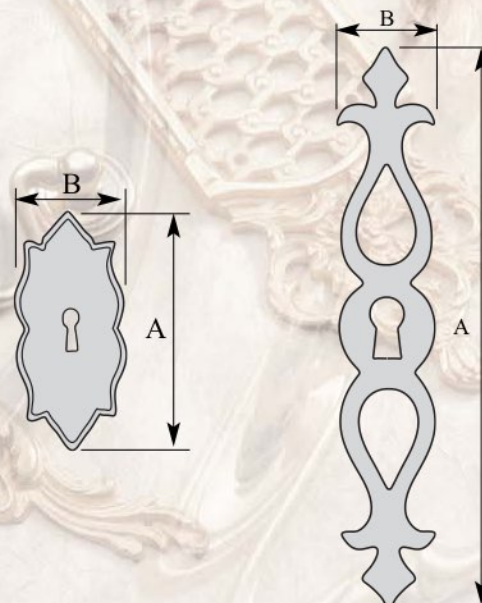



# BRASS ESCUTCHEONS

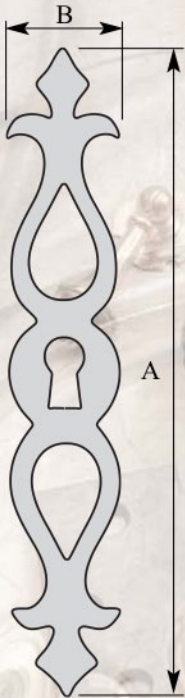
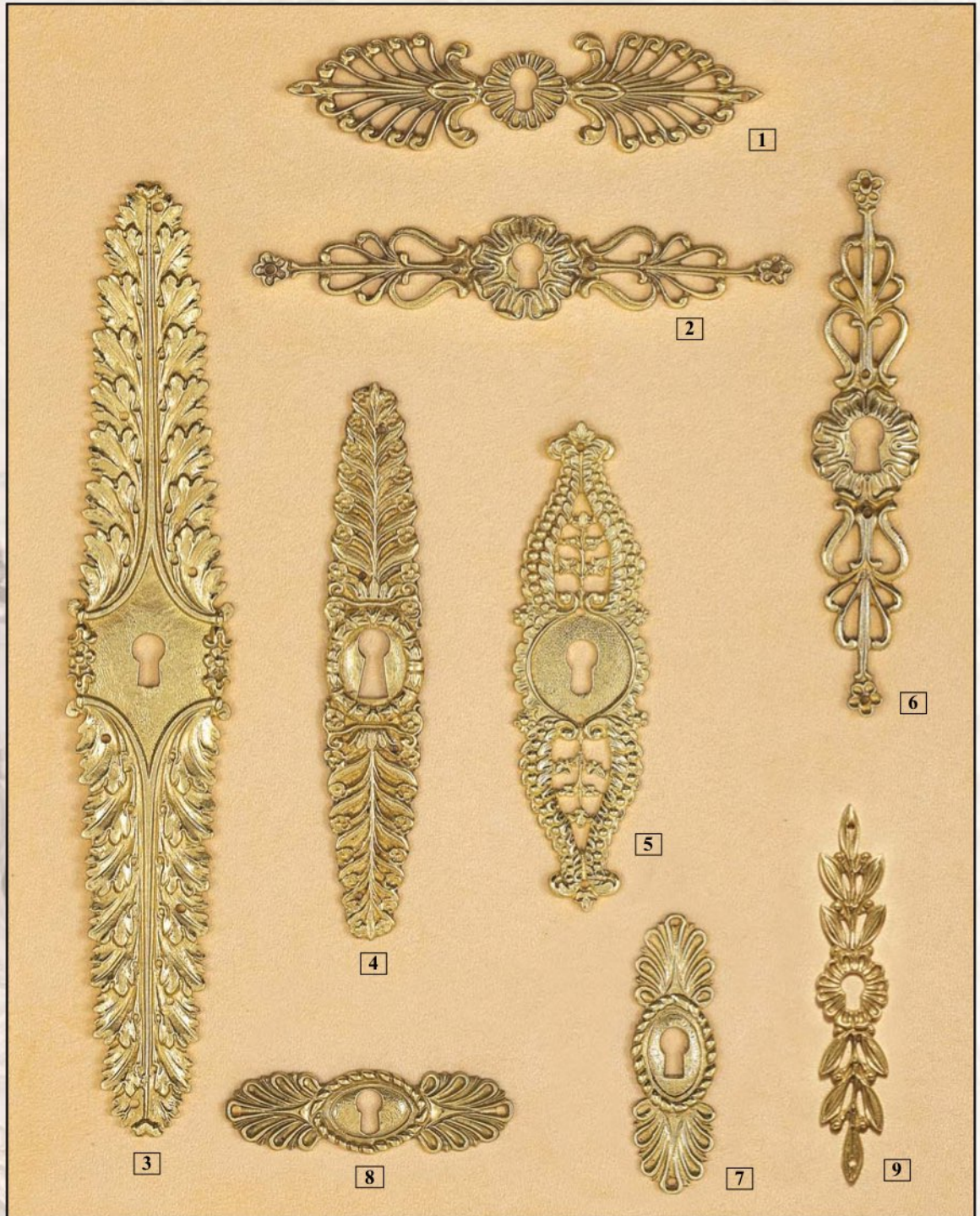

**NOTE:** Some escutcheons are sold as pairs.

BRASS		A	B
<b>1</b>	08.204.9	1-3/8"	5-1/4"
<b>2</b>	08.239.9	1-3/16"	6"
<b>3</b>	08.0237.2622	10-3/8"	1-3/4"
<b>4</b>	08.571.2	6-1/16"	1-1/16"

BRASS		A	B
<b>5</b>	08.209.2	5-3/8"	1-1/2"
<b>6</b>	08.239.2	6"	1-3/16"
<b>7</b>	08.428.2	3-1/16"	15/16"
<b>8</b>	08.428.9	15/16"	3"
<b>9</b>	08.180.2	4-3/4"	7/8"

# BRASS KEYHOLES

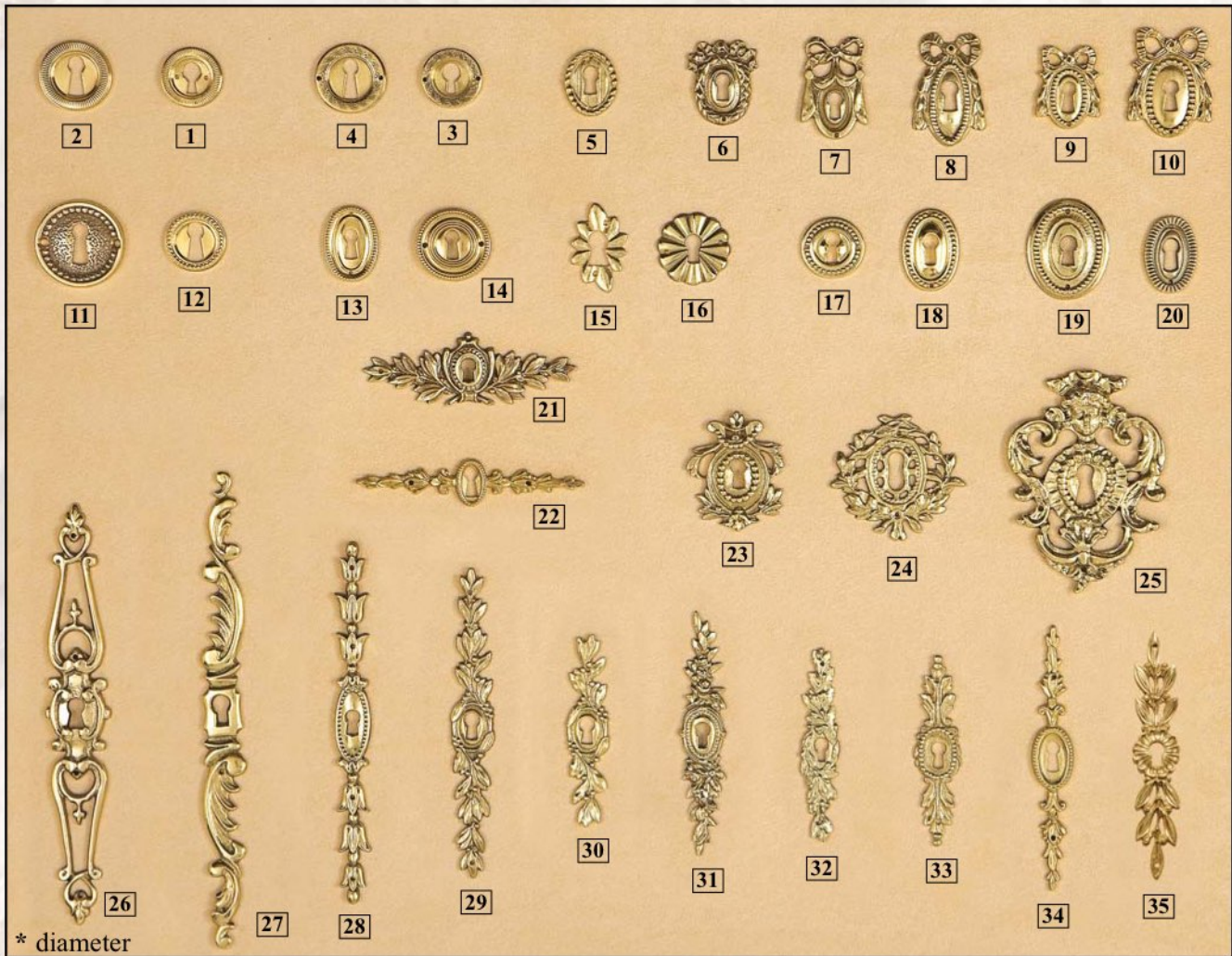

\* diameter

NOTE: Some escutcheons are sold as pairs.

BRASS	A	B	
1	09.783.2	1-3/16"	*
2	09.783.35	1-3/8"	*
3	09.883	1-1/8"	*
4	09.883.35	1-1/4"	*
5	09.182	1-1/4"	1-1/16"
6	09.262	1-5/8"	1-5/16"
7	09.250.2	1-15/16"	1-1/4"
8	09.458.2	2-3/16"	1-3/8"
9	09.0458.0402	1-5/8"	1-1/4"
10	09.0458.0502	2-1/8"	1-9/16"
11	09.0526.0002	1-5/8"	*
12	09.983.302	1-3/16"	*
13	09.4220.2	1-3/8"	1"
14	09.0656.0352	1-3/8"	*
15	09.0668.0272	1-3/4"	1-1/8"
16	09.0337.0352	1-3/8"	*
17	09.4220.302	1-1/4"	*



BRASS	A	B	
18	09.4220.42	1-5/8"	1-1/8"
19	09.466	1-15/16"	1-1/2"
20	09.0300.0372	1-1/2"	1"
21	09.249.9	1-3/8"	4-1/16"
22	08.0313.1109	1"	4-1/4"
23	09.698	2-7/16"	1-15/16"
24	09.640	2-1/2"	2-9/16"
25	09.3455	4-3/8"	3"
26	08.3325	8-1/16"	1-3/8"
27	08.3324.2	9-5/16"	13/16"
28	08.231	7-3/16"	3/4"
29	08.268.152	6"	7/8"
30	08.268.92	3-7/8"	7/8"
31	08.2320	4-7/8"	15/16"
32	08.2197	3-7/8"	3/4"
33	08.0224.0952	3-3/4"	7/8"
34	08.0313.1302	5-1/4"	13/16"
35	08.180.2	4-3/4"	7/8"



# BRASS KEYHOLES



BRASS

	A	B
<b>1</b>	09.177	2-1/2" 1/15/16"
<b>2</b>	09.990	3-1/16" 1-15/16"
<b>3</b>	09.0144.0872	3-1/2" 2-1/4"
<b>4</b>	09.701	4-1/4" 3-7/16"
<b>5</b>	09.0455.0552	2-3/16" 1-7/16"
<b>6</b>	09.3037.2	3" 1-3/4"
<b>7</b>	09.0455.0802	3-1/4" 2"
<b>8</b>	08.0320.0152	5-7/8" 3/4"
<b>9</b>	08.0320.0222	8-3/4" 1-1/8"
<b>10</b>	08.0310.0132	5-1/8" 3/4"
<b>11</b>	08.0310.0172	6-3/4" 1"
<b>12</b>	08.0310.0222	8-1/4" 1-1/8"
<b>13</b>	09.1045.1352	5-1/4" 4-1/4"



BRASS

	A	B
<b>14</b>	08.0397.0982	3-3/4" 3/4"
<b>15</b>	08.0282.1602	6" 3/4"
<b>16</b>	08.0331.0902	3-1/2" 11/16"
<b>17</b>	08.519.2	5-1/2" 1"
<b>18</b>	08.546.2	8-3/8" 1-3/16"
<b>19</b>	08.98.2	9-7/8" 1-5/8"
<b>20</b>	09.5009.1002	1-1/8" 4"
<b>21</b>	09.0282.1612	1-1/8" 6-1/4"
<b>22</b>	09.4360.0402	1-5/8" 1-1/4"
<b>23</b>	09.4130.2	1-15/16" 15/16"
<b>24</b>	09.2081.2	2" 1-1/2"
<b>25</b>	09.257	1-11/16" 1-11/16"
<b>26</b>	09.324	1-7/8" 1-3/4"

# BRASS KEYHOLES

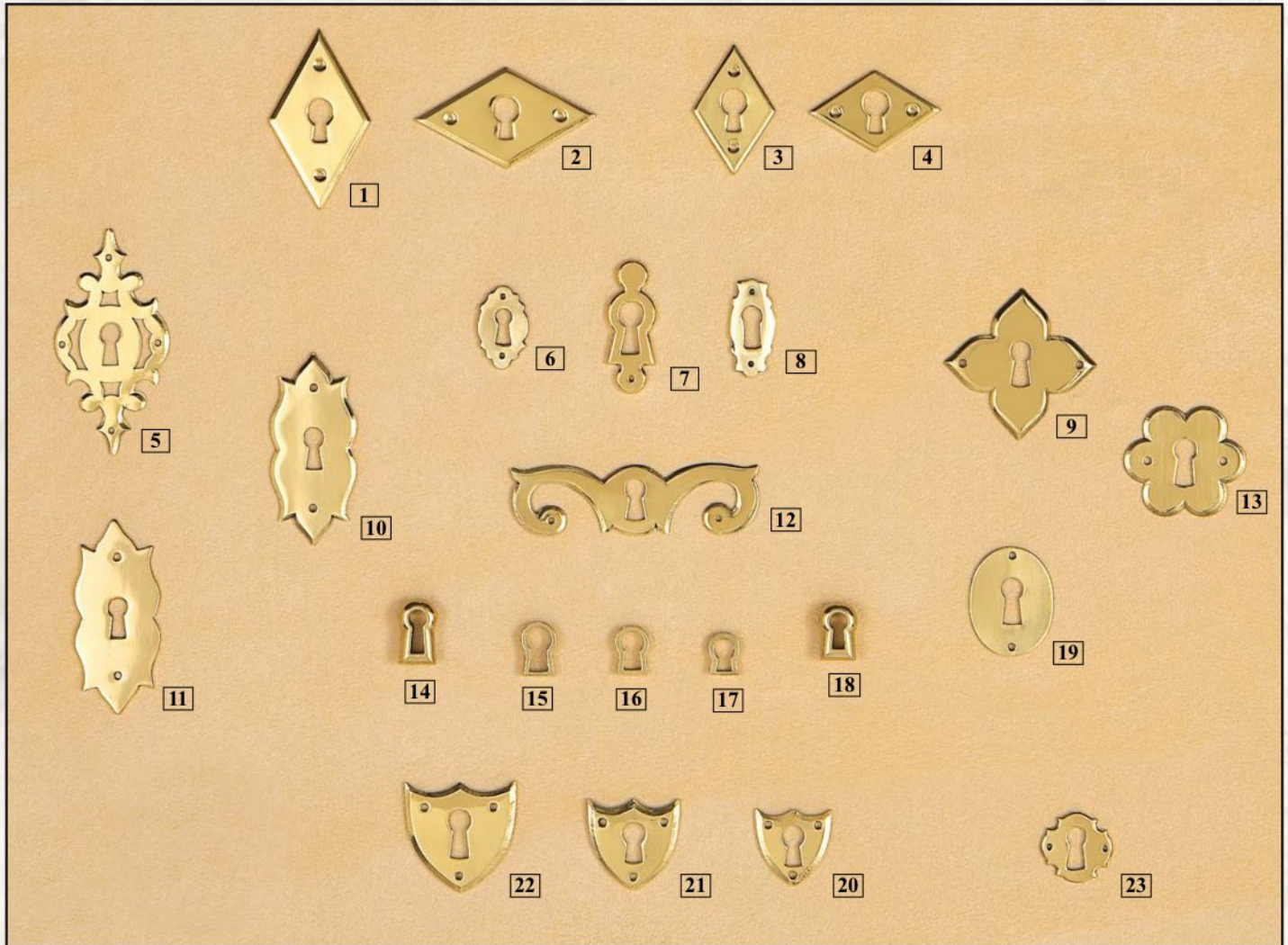

\* diameter

BRASS	A	B
<b>1</b> 09.3017.652	2-5/8"	1-1/2"
<b>2</b> 09.3017.65	1-1/2"	2-5/8"
<b>3</b> 09.3017.52	1-7/8"	1-3/16"
<b>4</b> 09.3017.50	1-3/16"	1-7/8"
<b>5</b> 09.1296.2	3-1/4"	1-5/8"
<b>6</b> 09.604	1-1/8"	5/8"
<b>7</b> 09.18.2	1-7/8"	3/4"
<b>8</b> 09.555	1-1/2"	5/8"
<b>9</b> 09.5138.2	2-3/16"	2-3/16"
<b>10</b> 09.5285.2	2-13/16"	1-1/4"
<b>11</b> 09.5285.2.5	2-7/8"	1-1/4"
<b>12</b> 09.2431.0002	1"	3-9/16"

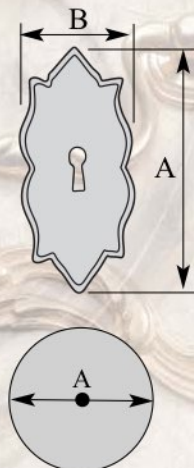

BRASS	A	B
<b>13</b> 09.1302.0002	1-5/8"	*
<b>14</b> 09.16.2	15/16"	7/8"
<b>15</b> 09.19.202	13/16"	1/2"
<b>16</b> 09.19.182	11/16"	1/2"
<b>17</b> 09.19.152	5/8"	7/16"
<b>18</b> 09.16.202	7/8"	3/4"
<b>19</b> 09.2435.0002	1-1/2"	1-3/16"
<b>20</b> 09.3051.252	1-1/8"	1-1/16"
<b>21</b> 09.3051.352	1-5/16"	1-5/16"
<b>22</b> 09.3051.422	1-5/8"	1-5/8"
<b>23</b> 09.0392.0002	1"	*



# IRON ESCUTCHEONS AND IRON KEYHOLES

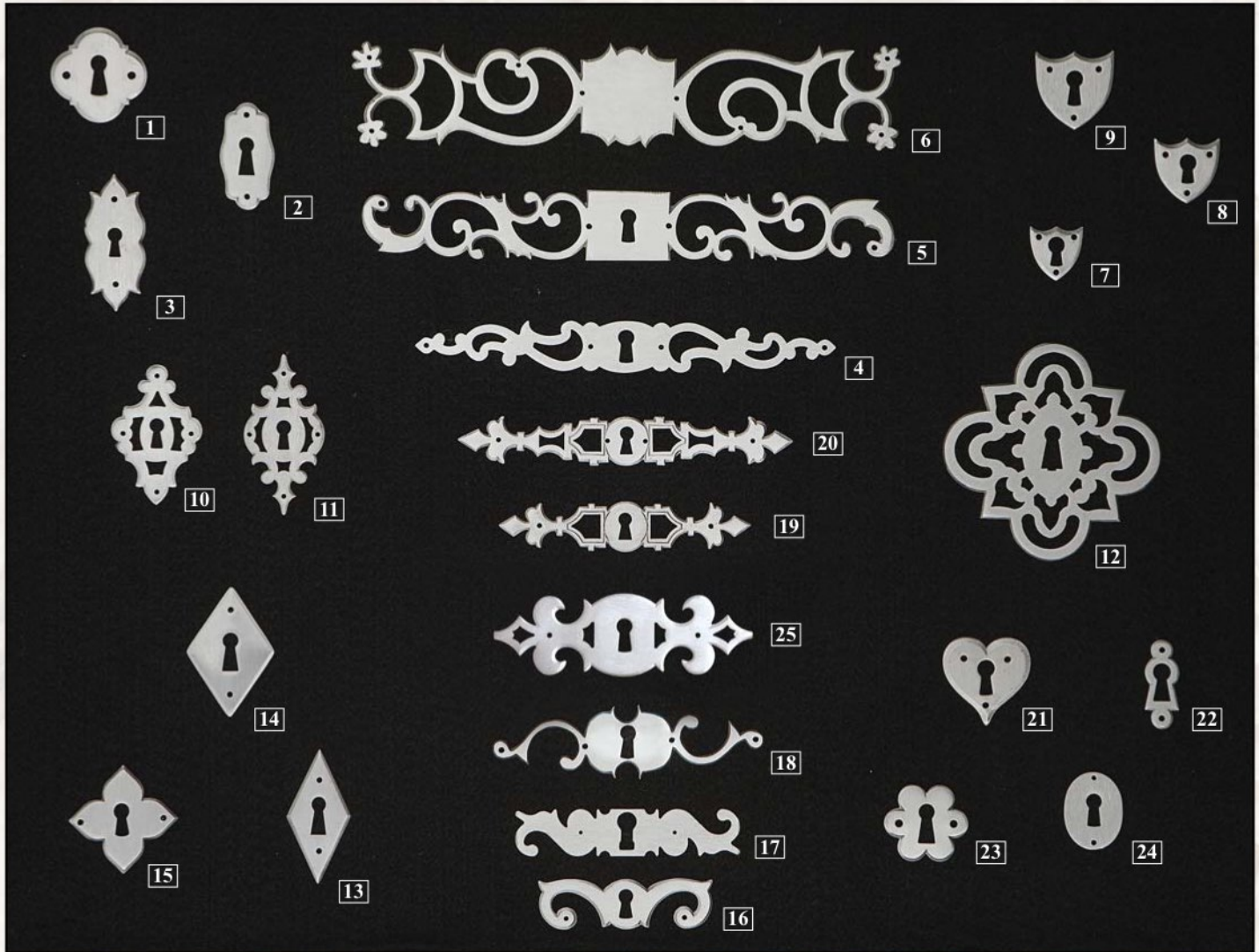

\* diameter

IRON	A	B
<b>1</b>	09.63.1	1-7/8"
<b>2</b>	09.1303.1	2-3/16"
<b>3</b>	09.5285.1	2-3/4"
<b>4</b>	09.2053.1	1-1/16"
<b>5</b>	09.0044.1	1-3/8"
<b>6</b>	09.0079.1	2-1/8"
<b>7</b>	09.3051.271	1-1/8"
<b>8</b>	09.3051.331	1-5/16"
<b>9</b>	09.3051.401	1-5/8"
<b>10</b>	09.91	2-7/8"
<b>11</b>	09.1296.1	3-1/4"
<b>12</b>	09.0125.0001	4-1/2"
<b>13</b>	09.100.1	2-11/16"

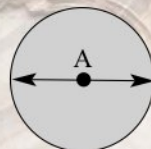
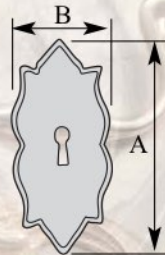
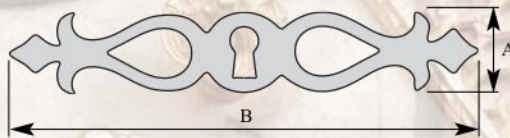

IRON	A	B
<b>14</b>	09.100.451	2-1/2"
<b>15</b>	09.5138.1	2-3/16"
<b>16</b>	09.2431.0001	1"
<b>17</b>	09.1277.18	1"
<b>18</b>	09.0076.0001	1-1/2"
<b>19</b>	08.9876.139	1-1/16"
<b>20</b>	09.9876.179	1-1/16"
<b>21</b>	09.105.1	1-13/16"
<b>22</b>	09.18.1	2"
<b>23</b>	09.1302.401	1-5/8"
<b>24</b>	09.2435.0001	1-1/2"
<b>25</b>	09.5166.1	1-11/16"

# BRASS ROSETTES

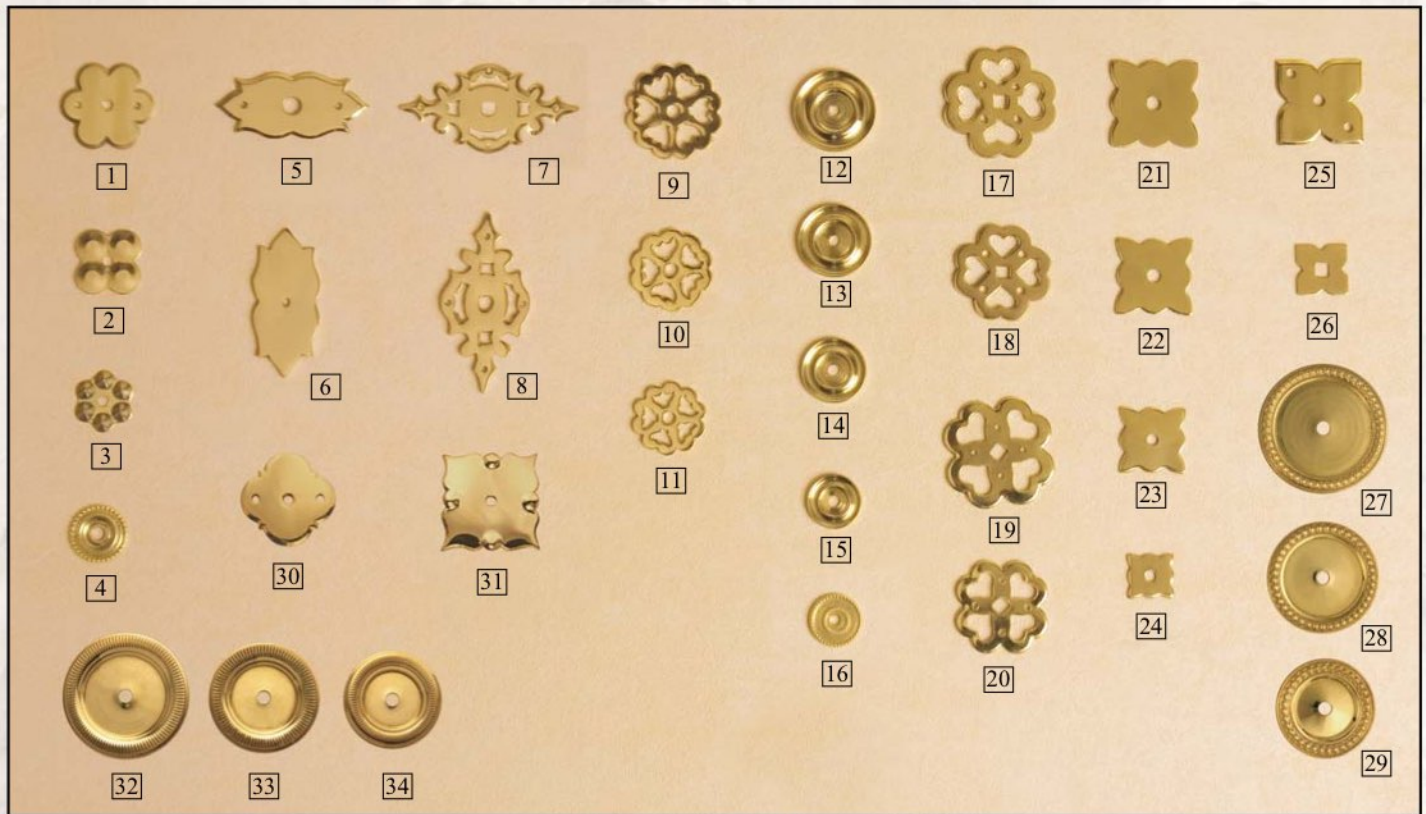

\* diameter

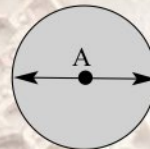
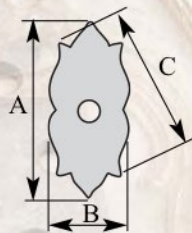

BRASS	A	B
<b>1</b>	12.1302.2	1-5/8" *
<b>2</b>	12.205.2	1-3/16" *
<b>3</b>	12.106.2	1-1/8" *
<b>4</b>	12.4121.2	1" *
<b>5</b>	12.5285.2	1-1/4" 2-3/4"
<b>6</b>	12.5285.2.5	2-7/8" 1-1/4" thicker
<b>7</b>	12.1296.2	1-5/8" 3-1/4"
<b>8</b>	12.1296.2.5	3-5/16" 1-11/16" thicker
<b>9</b>	12.13.452	1-3/4" *
<b>10</b>	12.13.402	1-1/2" *
<b>11</b>	12.13.352	1-3/8" *
<b>12</b>	12.1500.0382	1-1/2" *
<b>13</b>	12.1500.0342	1-3/8" *
<b>14</b>	12.1500.0302	1-3/16" *
<b>15</b>	12.1500.0252	1" *
<b>16</b>	12.2150	7/8" *
<b>17</b>	12.2704.52.5	2-1/16" *

BRASS	A	B
<b>18</b>	12.2704.42.5	1-3/4" *
<b>19</b>	12.2704.52	2-1/16" *
<b>20</b>	12.2704.42	1-3/4" *
<b>21</b>	12.2013.462	1-1/2" 1-1/2"
<b>22</b>	12.2013.352	1-3/8" 1-3/8"
<b>23</b>	12.2013.302	1-3/16" 1-3/16"
<b>24</b>	12.2013.202	7/8" 7/8"
<b>25</b>	12.5138.2	1-9/16" 1-9/16"
<b>26</b>	12.204.2	15/16" 15/16"
<b>27</b>	12.983.402	1-1/2" *
<b>28</b>	12.983.352	1-3/8" *
<b>29</b>	12.983.302	1-3/16" *
<b>30</b>	12.300.2	2" 2"
<b>31</b>	12.63.2	1-7/8" 1-7/8"
<b>32</b>	12.783.402	1-1/2" *
<b>33</b>	12.783.352	1-3/8" *
<b>34</b>	12.783.302	1-3/16" *



# BRASS ROSETTES



\* diameter

BRASS		A	B	
1	12.2501.552	2-1/4"		*
2	12.2501.45	2"		*
3	12.2501.452	2-1/8"		*
4	12.2501.302	1"		*
5	12.0237.0002	1-3/4"		*
6	12.2501.352	1-3/8"		*
7	12.2177.0002	2-1/4"		*
8	12.2176.0002	2"		*
9	12.2175.0002	1-7/8"		*
10	12.0194.0002	1-3/8"		*
11	12.0193.0652	2-1/2"		*
12	12.0170.0502	1-7/8"		*
13	12.0315.0322	1-1/4"		*
14	25.0260.0322	1"		*
15	12.1600.0232	7/8"		*
16	12.0226.0222	7/8"		*
17	25.0140.0802	3-1/8"	2-3/8"	
18	25.0580.0352	1-5/16"	1-5/16"	

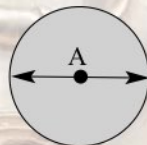
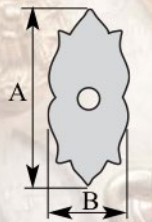

BRASS		A	B	
19	25.0158.0402	1-5/8"	1-1/4"	
20	25.2268.2	1-3/4"		*
21	25.0812.0662	2-5/8"		*
22	25.1000.612	2-3/8"		*
23	25.1000.502	2"		*
24	25.1000.482	1-3/4"		*
25	25.0812.0352	1-1/8"		*
26	25.0812.0202	11/16"		*
27	12.0516.0002	1-3/4"		*
28	12.0526.0002	1-5/8"		*
29	12.0426.0002	1-5/8"		*
30	12.2715.2	2-1/4"	2-1/4"	
31	12.9650	2-1/8"	2-1/8"	
32	12.2719.2	1-3/4"	1-3/4"	

# IRON ROSETTES

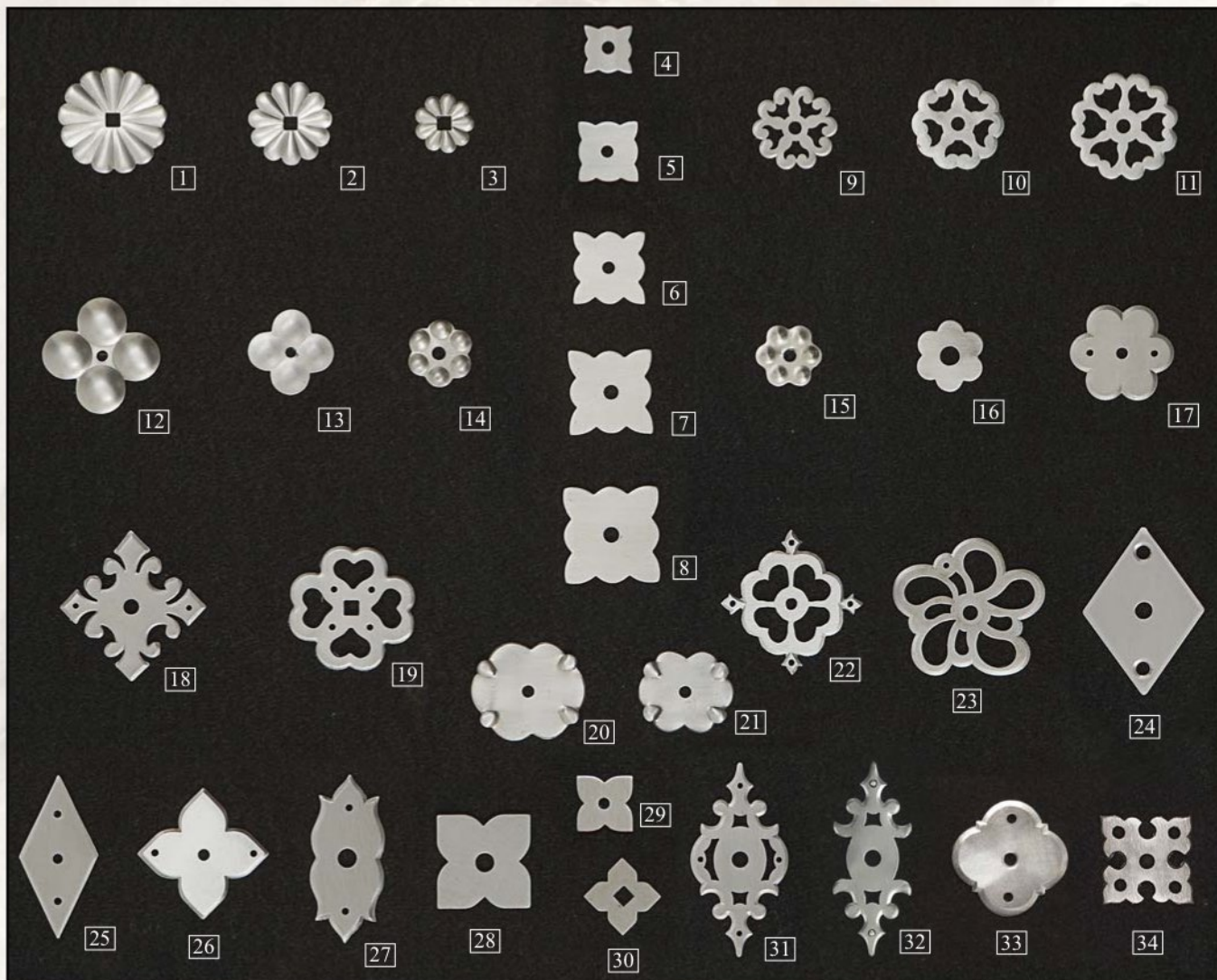

\* diameter

IRON		A	B	
1	12.2026.0451	1-3/4"		*
2	12.2026.0351	1-3/8"		*
3	12.2026.0251	1"		*
4	12.2013.201	7/8"	7/8"	
5	12.2013.251	1"	1"	
6	12.2013.301	1-3/16"	1-3/16"	
7	12.2013.351	1-3/8"	1-3/16"	
8	12.2013.401	1-1/2"	1-1/2"	
9	12.13.351	1-3/8"		*
10	12.13.401	1-1/2"		*
11	12.13.451	1-3/4"		*
12	12.205.481	1-5/8"	1-5/8"	
13	12.205.1	1-3/16"	1-3/16"	
14	12.106.1	1-1/8"		* round tip
15	12.107.1	1-1/8"		* pointy tip
16	12.1302.0301	1-1/8"		*
17	12.1302.0401	1-3/4"		*

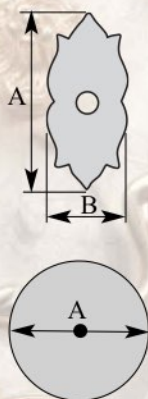

IRON		A	B	
17	12.1302.0601	2-3/8"		*
18	12.8040.1	1-3/4"	1-3/4"	
19	12.2704.51	2"		*
20	12.2019.401	1-5/8"	1-7/8"	
21	12.2019.301	1-3/8"	1-5/8"	
22	12.2719.1	1-3/4"	1-3/4"	
23	12.8030.1	2-1/2"		*
24	12.100.451	2-3/4"	2"	
25	12.100.1	2-5/8"	1-3/8"	
26	12.5138.1	1-9/16"	1-9/16"	
27	12.5285.1	2-3/4"	1-1/4"	
28	12.0722.0401	1-9/16"	1-9/16"	
29	12.0722.0001	15/16"	15/16"	*
30	12.204.1	15/16"	15/16"	*
31	12.1296.1	3-1/4"	1-5/8"	*
32	12.1297.1	3-1/4"	1-3/8"	
33	12.63.1**	1-7/8"	1-7/8"	*
34	12.1515.1	1-3/8"	1-3/8"	

\*\* Also available with a keyhole.



# BRASS SABOTS AND CASTERS

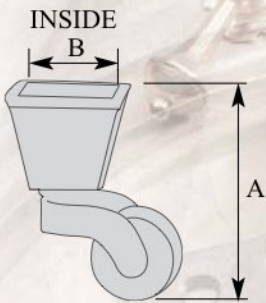

BRASS	A	B
<b>1</b>	15.129.182	1-1/4"
<b>1</b>	15.129.252	1-5/8"
<b>1</b>	15.129.322	2"
<b>2</b>	15.130.202	1-7/8" 3/4"
<b>2</b>	15.130.252	2-5/16" 1"
<b>2</b>	15.130.302	2-5/8" 1-1/4"
<b>3</b>	15.0910.2	2-1/2" 1-1/4"
<b>4</b>	15.128.192	1-13/16" 3/4"
<b>4</b>	15.128.252	2-1/4" 1"
<b>4</b>	15.128.322	2-11/16" 1-1/4"
<b>5</b>	15.1324.0302	2-7/8" 1-1/4"
<b>6</b>	15.1321.0352	2-1/2" 1-1/4"
<b>7</b>	15.1326.0252	2-1/2" 1-1/8"
<b>8</b>	15.1327.2	3" 1-1/4"
<b>9</b>	25.145.152	1-1/16" 5/8"
<b>9</b>	25.145.202	1-1/4" 13/16"
<b>9</b>	25.145.252	1-3/8" 1"
<b>9</b>	25.145.452	1-7/8" 1-1/8"
<b>10</b>	15.131.132	7/8" 9/16"
<b>10</b>	15.131.152	1" 5/8"

BRASS	A	B
<b>10</b>	15.131.172	1-1/16" 11/16"
<b>10</b>	15.131.192	1-1/8" 3/4"
<b>10</b>	15.131.212	1-3/16" 13/16"
<b>10</b>	15.131.232	1-1/4" 15/16"
<b>10</b>	15.131.252	1-1/4" 1"
<b>10</b>	15.131.272	1-1/4" 1/16"
<b>10</b>	15.131.302	1-1/2" 1-3/16"
<b>10</b>	15.131.352	1-9/16" 1-3/8"
<b>10</b>	15.131.402	1-5/8" 1-9/16"
<b>11</b>	15.127.132	11/16" 1/2"
<b>11</b>	15.127.152	3/4" 5/8"
<b>11</b>	15.127.172	13/16" 11/16"
<b>11</b>	15.127.192	7/8" 3/4"
<b>11</b>	15.127.212	1" 13/16"
<b>11</b>	15.127.232	1" 15/16"
<b>11</b>	15.127.252	1" 1"
<b>11</b>	15.127.272	1-3/16" 1-1/16"
<b>11</b>	15.127.302	1-1/4" 1-3/16"
<b>11</b>	15.127.352	1-3/8" 1-3/8"

# BRASS HOOKS

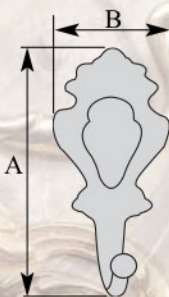

BRASS		A	B
<b>1</b>	25.1500.52	1-7/8"	7/8"
<b>2</b>	25.1500.102	4"	2"
<b>3</b>	25.1500.202	8"	2"
<b>4</b>	25.1509.42	2"	5/8"
<b>5</b>	25.1520.52	2-1/8"	1-1/4"
<b>6</b>	25.1520.102	4-1/2"	2-1/2"
<b>7</b>	25.1521.2	8"	2-1/2"

BRASS		A	B
<b>8</b>	25.1508.42	2-1/2"	1-1/2"
<b>9</b>	25.1506.42	1-3/8"	diameter
<b>10</b>	25.1535.2	5-3/4"	1-3/16"
<b>11</b>	25.1536.2	3-1/8"	1-3/16"
<b>12</b>	25.1510.52	1-7/8"	7/8"
<b>13</b>	25.1510.102	4"	1-3/4"
<b>14</b>	25.1511.2	7-1/4"	1-3/4"



# BRASS MOULDINGS

Approximately 39-1/2" (1 meter) long

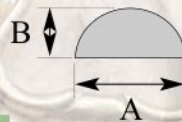

BRASS		A	B
<b>1</b>	11.01.2	1-3/8"	1/2"
<b>2</b>	11.02.2	1-3/16"	3/4"
<b>3</b>	11.03.2	7/8"	7/8"
<b>4</b>	11.04.2	13/16"	3/8"
<b>5</b>	11.05.2	13/16"	3/8"
<b>6</b>	11.06.2	11/16"	1/2"
<b>7</b>	11.07.2	11/16"	3/8"
<b>8</b>	11.08.2	3/4"	1/4"
<b>9</b>	11.09.2	5/8"	1/2"

BRASS		A	B
<b>10</b>	11.10.2	7/16"	1/4"
<b>11</b>	11.11.2	7/16"	3/8"
<b>12</b>	11.12.2	3/8"	3/16"
<b>13</b>	11.13.2	5/16"	1/8"
<b>14</b>	11.14.2	1/4"	1/4"
<b>15</b>	11.PERL.0502	1/4"	
<b>16</b>	11.PERL.0402	3/16"	
<b>17</b>	11.PERL.0302	1/8"	

# BRASS MOULDINGS

Approximately 39-1/2" (1 meter) long and under 1/8" thick

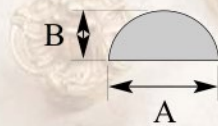

BRASS		A	B
<b>1</b>	11.M815.0002	3/8"	
<b>2</b>	11.M835.0002	3/16"	
<b>3</b>	11.M819.0002	3/8"	
<b>4</b>	11.M814.0002	3/8"	
<b>5</b>	11.M838.0002	5/16"	
<b>6</b>	11.M842.0002	3/16"	
<b>7</b>	11.M820.0002	5/16"	
<b>8</b>	11.M832.0002	3/16"	
<b>9</b>	11.M833.0002	1/8"	



# BRASS MESH GRILLS

MORE DESIGNS AVAILABLE

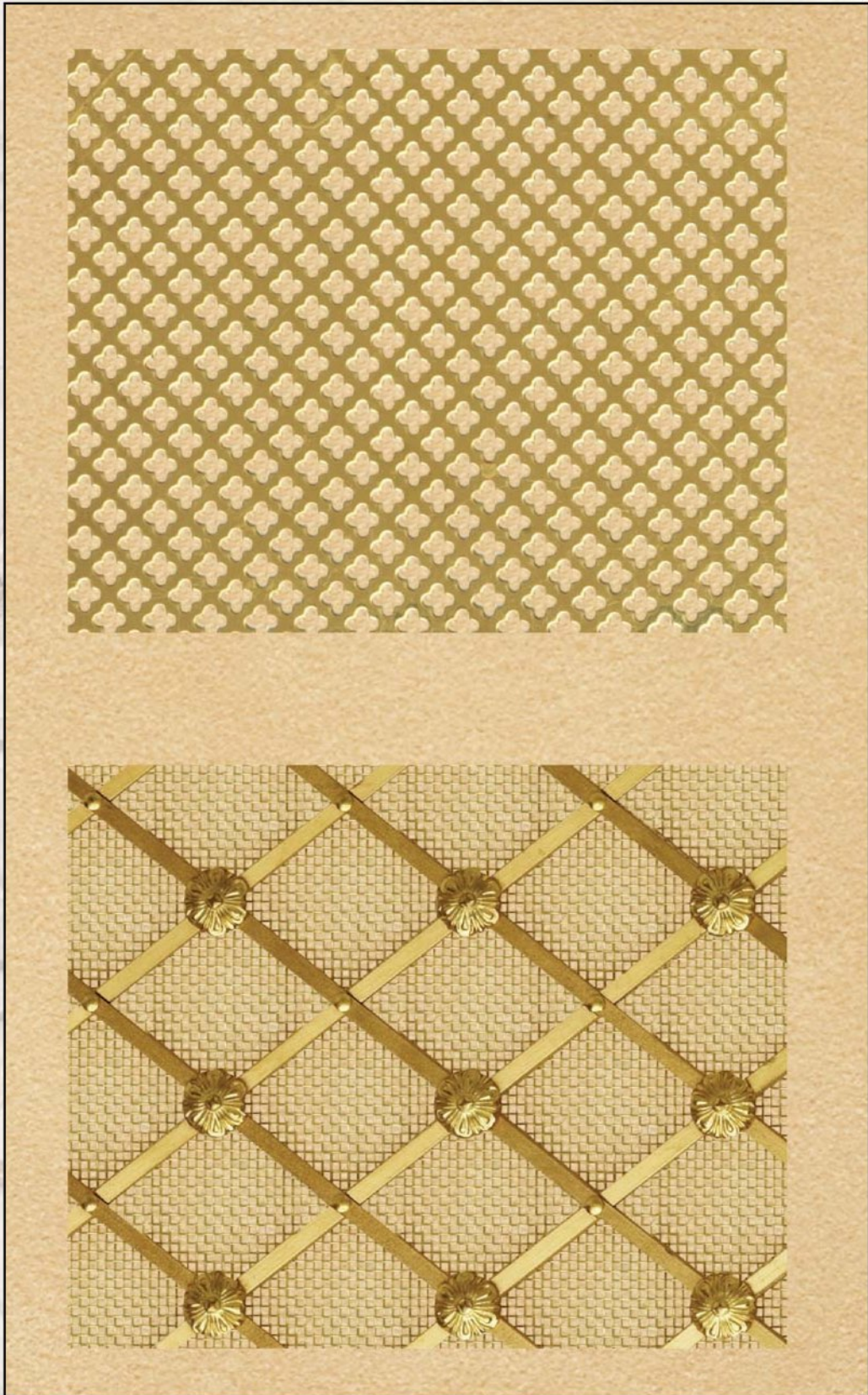

CUSTOM ORDER

# FRENCH RUSTED IRON COLLECTION



(No additional finish is required unless requested)

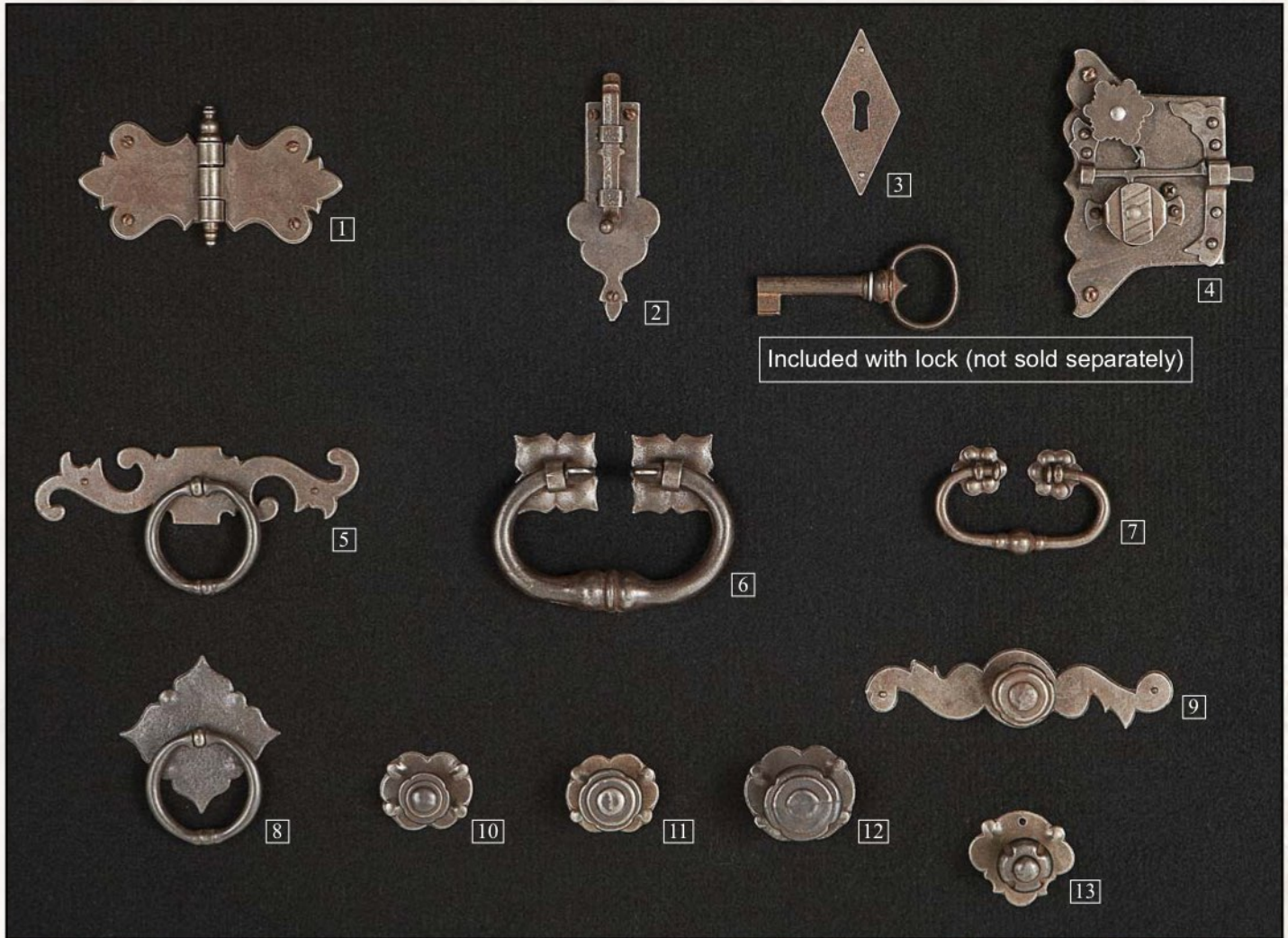

Included with lock (not sold separately)

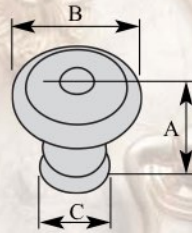
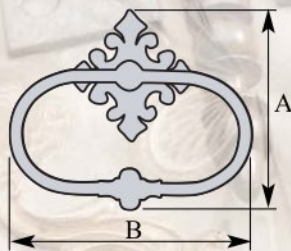

IRON		A	B		
<b>1</b>	16.2700.3	2-3/8"	4-1/2"		
<b>2</b>	18.100.3	3-3/4"	1-5/8"		
<b>3</b>	09.85.3	2-7/8"	1-3/8"		
<b>4</b>	04.210.403L/R		1-1/2"	* Backset	* key included
<b>5</b>	05.100.3	2-1/2"	5-1/2"		
<b>6</b>	05.0431.3	3"	4-1/8"		
<b>7</b>	05.0531.3	1-3/4"	3"		

IRON		A	B	C	
<b>8</b>	05.300.3	3-1/4"	2-3/4"		
<b>9</b>	06.113.3	1-3/8"	5-1/4"		
<b>10</b>	06.2019.0203	7/8"	3/4"	1-5/8"	
<b>11</b>	06.2019.0253	1-1/8"	1"	1-5/8"	
<b>12</b>	06.2019.0303	1-1/4"	1-3/16"	2"	
<b>13</b>	06.0119.0241	1-3/8"	15/16"	1-7/8"	



# BLACKSMITH IRON COLLECTION

(No additional finish is required unless requested)

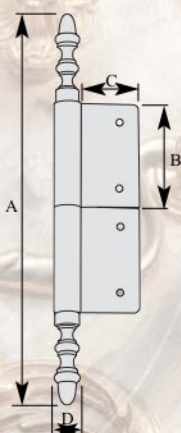
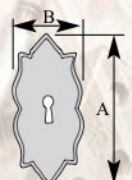
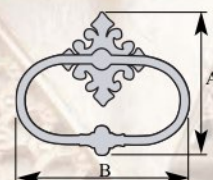
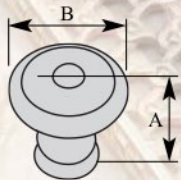
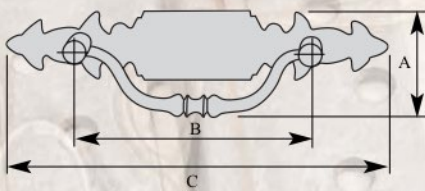
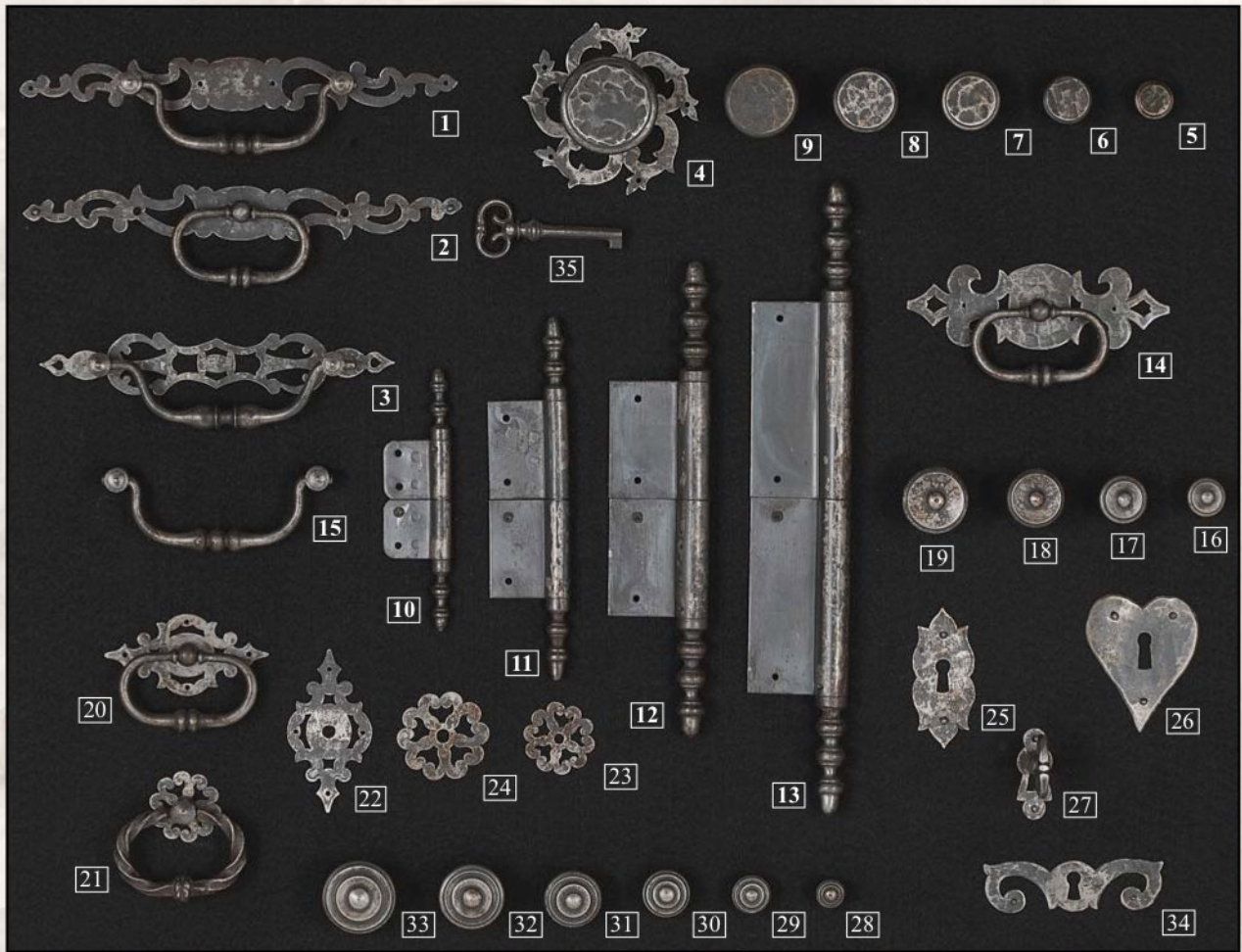

IRON

		A	B	C
<b>1</b>	05.2054.00K3	2-1/16"	4"	8-1/2"
<b>2</b>	05.2055.00K3	2-1/16"		8-1/2"
<b>3</b>	05.3138.00K3	2-1/8"	4-1/2"	6-3/4"
<b>4</b>	06.2001.0503	1-3/8"	2" rosette optional	
<b>4</b>	12.1201.0093	3-1/2"	diameter	
<b>5</b>	06.2001.0203	1/2"	3/4"	
<b>6</b>	06.2001.0253	5/8"	1"	
<b>7</b>	06.2001.0303	7/8"	1-3/16"	
<b>8</b>	06.2001.0353	1"	1-3/8"	
<b>9</b>	06.2001.0403	1-1/8"	1-1/2"	
<b>10</b>	01.11.133	5-1/4"		1-3/8"
<b>11</b>	01.11.183	7-1/4"		1-5/8"
<b>12</b>	01.11.243	9-1/2"		2"
<b>13</b>	01.11.323	12-1/2"		2"
<b>14</b>	05.5166.00K3	2"		5-3/4"
<b>15</b>	05.1554.3	1-5/8"	4"	4-1/4"
<b>16</b>	06.68.203	7/8"	3/4"	
<b>17</b>	06.68.253	1-1/16"	1"	

IRON

		A	B	C
<b>18</b>	06.68.303	1-5/16"	1-3/16"	
<b>19</b>	06.68.353	1-7/16"	1-3/8"	
<b>20</b>	05.1296.00K3	2-1/2"	3-1/2"	
<b>21</b>	05.60.653	2-5/8"	2-5/8"	
<b>22</b>	12.1296.3	3-1/4"	1-5/8"	
<b>23</b>	12.13.353	1-3/8"		diameter
<b>24</b>	12.13.453	1-3/4"		diameter
<b>25</b>	09.5285.3	2-3/4"	1-1/4"	
<b>26</b>	09.1003.0073	2-3/4"	2-3/8"	
<b>27</b>	09.18.3	1-3/4"	7/8"	
<b>28</b>	06.1538.153	9/16"	9/16"	
<b>29</b>	06.1538.203	5/8"	3/4"	
<b>30</b>	06.1538.253	13/16"	1"	
<b>31</b>	06.1538.303	15/16"	1-3/16"	
<b>32</b>	06.1538.353	1-1/8"	1-3/8"	
<b>33</b>	06.1538.403	1-1/4"	1-1/2"	
<b>34</b>	06.2431.0003	1-1/8"	3-1/2"	
<b>35</b>	10.4460.403	3"	1-3/16"	1-1/2"

# BLACKSMITH IRON ESCUTCHEONS COLLECTION

(No additional finish is required unless requested)

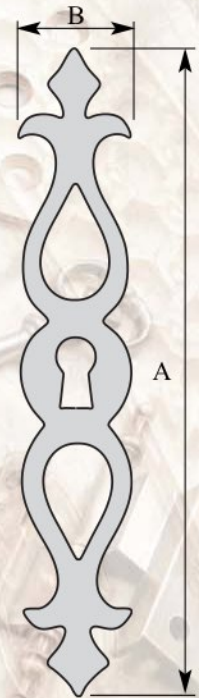
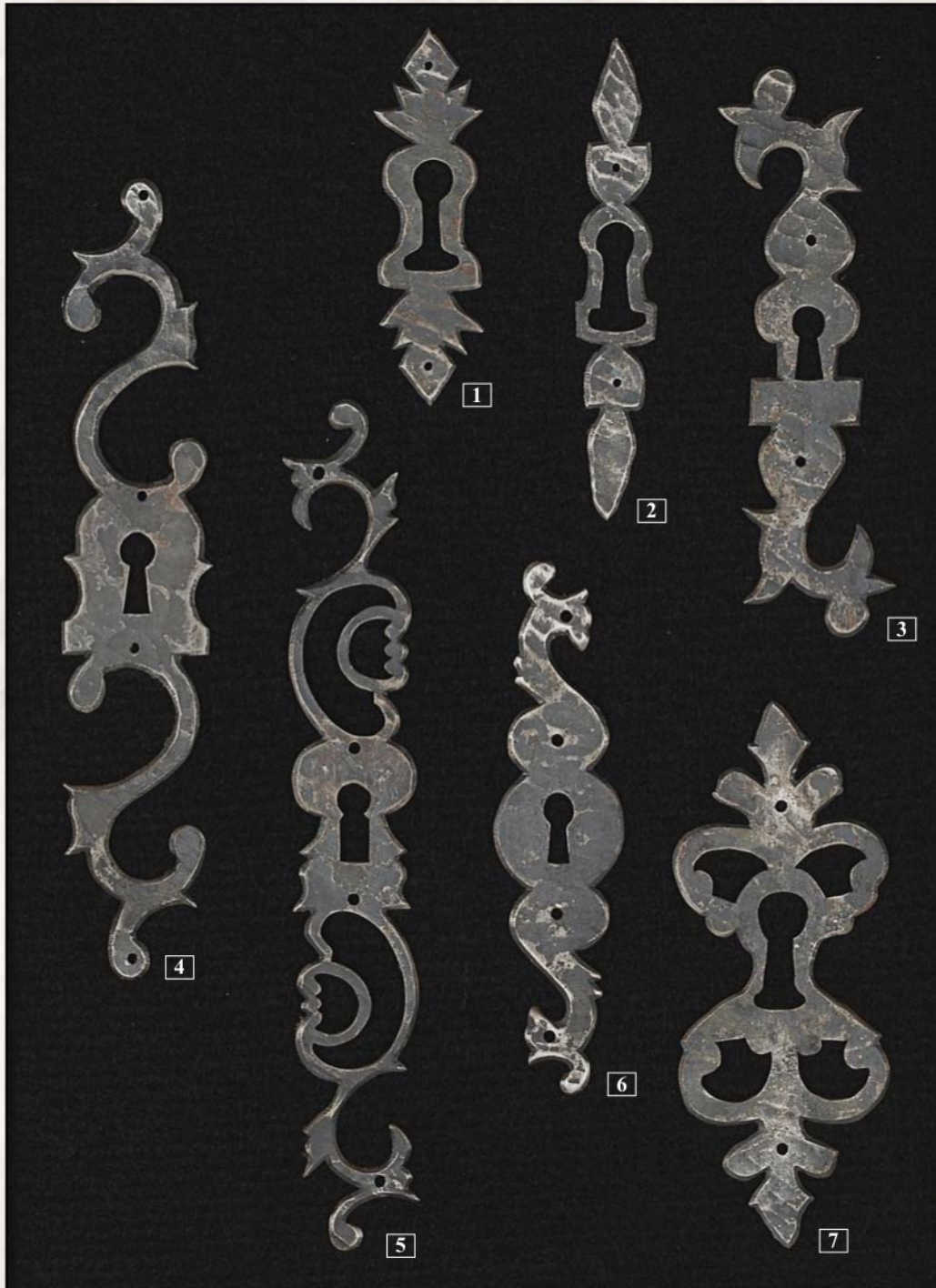

IRON		A	B
<b>1</b>	09.1004.0093	3-5/8"	1"
<b>2</b>	09.1005.0113	4-3/4"	7/8"
<b>3</b>	08.0083.0143	5-5/8"	1-7/8"
<b>4</b>	08.0064.0193	7-3/4"	1-1/2"

IRON		A	B
<b>5</b>	08.0075.0213	8-3/8"	1-1/4"
<b>6</b>	09.1007.0133	5-1/4"	1-3/8"
<b>7</b>	09.1002.0133	5-1/2"	2-1/8"



# ENGLISH BLACK IRON COLLECTION

(No additional finish is required unless requested)

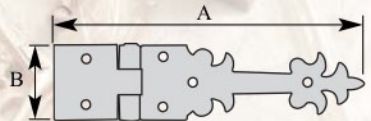
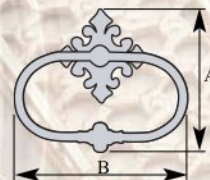
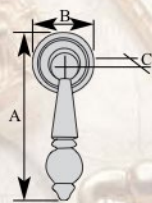
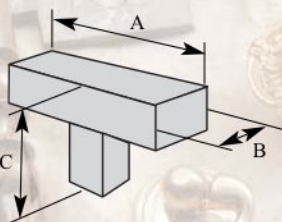
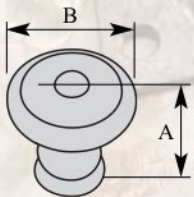
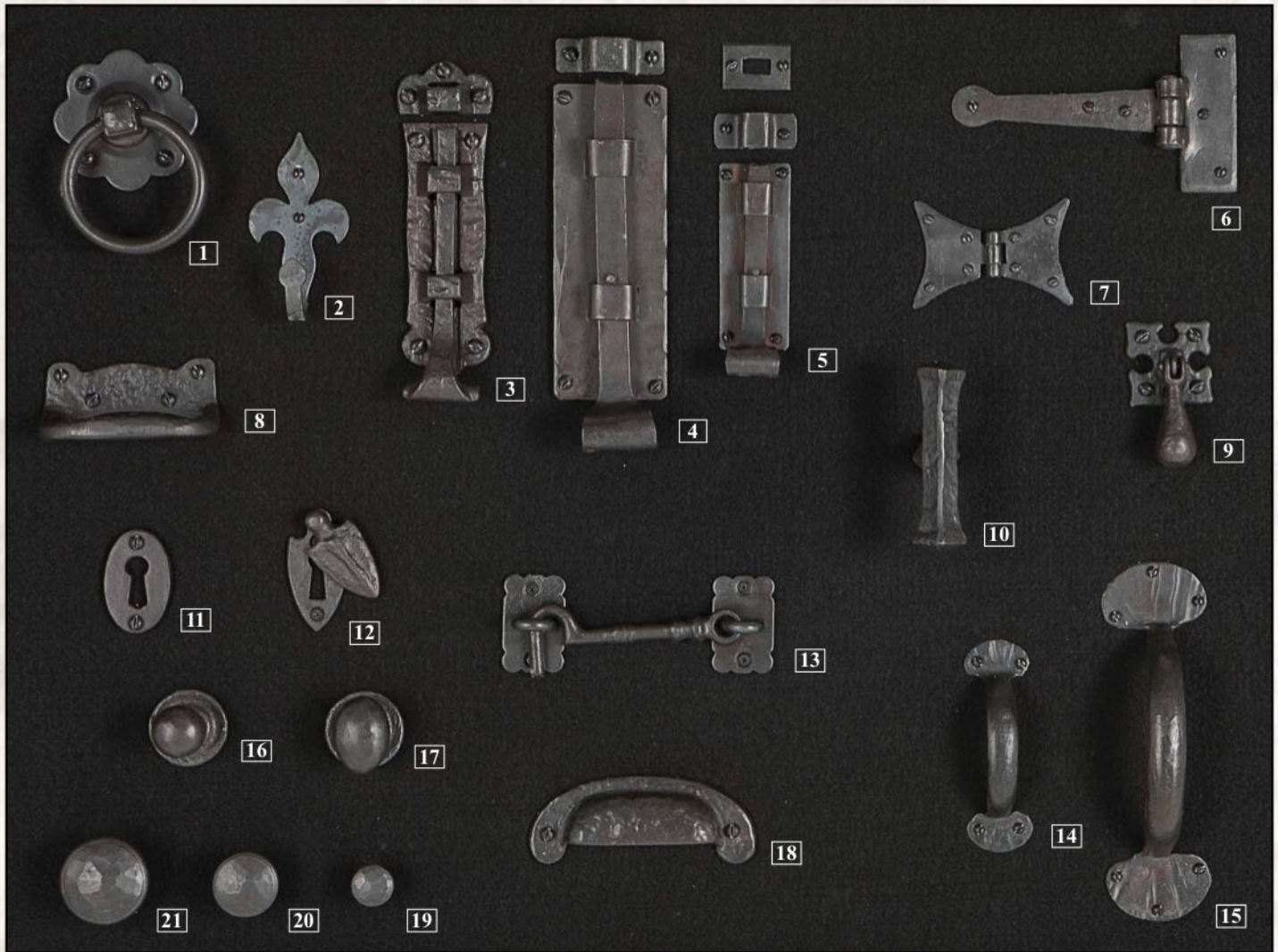

IRON		A	B	C
<b>1</b>	05.9010.0001	4"	2-5/8"	
<b>2</b>	25.0100.0001	3-3/4"	1-3/4"	
<b>3</b>	18.430.1	5-3/4"	6"	1-1/2"
<b>4</b>	18.1400.1451	5-3/4"	2-1/8"	
<b>5</b>	18.1400.0851	3-1/2"	1-3/8"	
<b>6</b>	16.6010.1	5-1/4"	3"	
<b>7</b>	16.6000.0001	3"	2"	
<b>8</b>	05.115.1	1-1/2"	3-1/4"	
<b>9</b>	07.102.1	2-1/2"	1-1/2"	
<b>10</b>	06.3030.0001	3-3/8"	1"	2"
<b>11</b>	09.140.1	2-3/8"	1-1/16"	

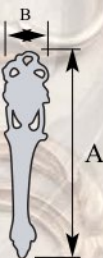

IRON		A	B
<b>12</b>	09.504.1	2"	1-3/16"
<b>13</b>	20.505.101	1-3/4"	5"
<b>14</b>	05.9000.0101	4"	1-1/4"
<b>15</b>	05.9000.0701	6-1/2"	2"
<b>16</b>	06.3000.0251	1-3/8"	1-3/8"
<b>17</b>	06.3010.0251	1-3/8"	1-3/8"
<b>18</b>	05.0265.1501	4-1/8"	1-5/8"
<b>19</b>	06.3020.0201	7/8"	7/8"
<b>20</b>	06.3020.0301	1"	1-1/8"
<b>21</b>	06.3020.0401	1-1/4"	1-5/8"

# CAST IRON COLLECTION



IRON		A	B	C	D
<b>1</b>	19.634.1	9"	7-7/8"	1-1/4"	2-3/4"
<b>2</b>	05.634.1	5-3/4"	5"	3/4"	2-1/4"
<b>3</b>	06.69.1	1-1/4"	1-3/4"		
<b>4</b>	05.632.1	1-3/4"	4-1/4"		
<b>5</b>	06.72.1	1-1/2"			
<b>6</b>	06.71.1	1-1/2"			
<b>7</b>	05.630.1	1-3/4"	4-1/4"		
<b>8</b>	06.70.1	1-7/16"	1-3/4"		
<b>9</b>	05.633.1	6-5/8"	3-3/4"	1"	2-1/8"
<b>10</b>	19.633.1	13-1/2"	8"	1-3/4"	3-1/2"



# ASIAN BRASS COLLECTION

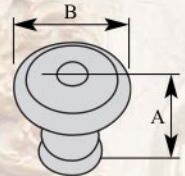
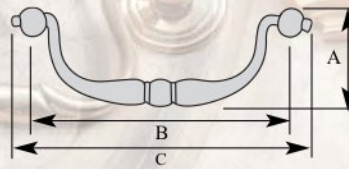
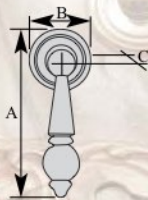
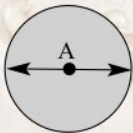
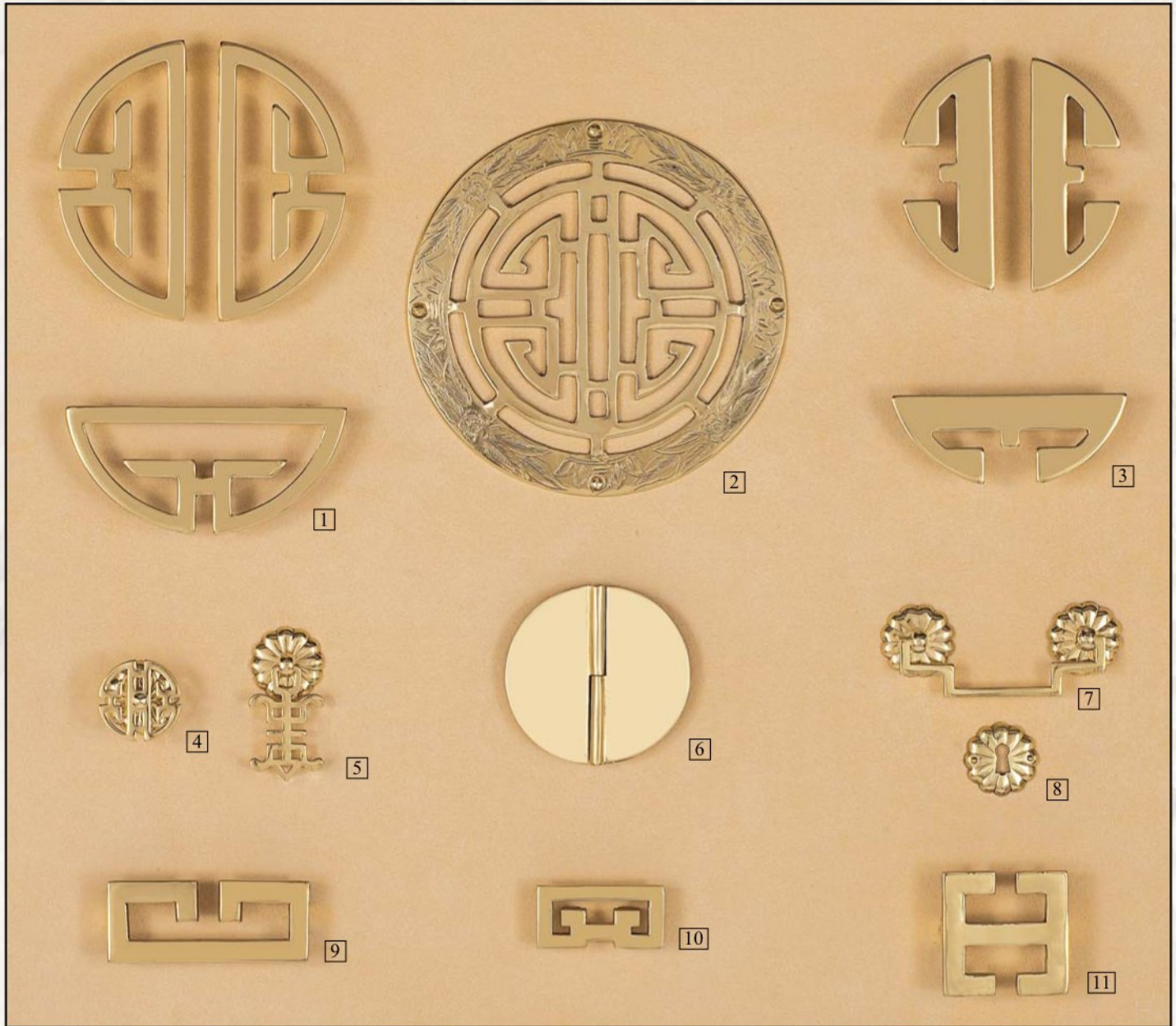

BRASS

		A	B
<b>1</b>	05.OP19.0502	2-1/4"	5"
<b>2</b>	25.W135.0702	7"	diameter
<b>3</b>	05.OP18.0422	1-5/8"	4-1/4"
<b>4</b>	06.OK19.0152	3/4"	1-1/2"
<b>5</b>	07.OD19.0202	1-3/8"	2-3/4"
<b>6</b>	01.1802.2.L/R	3-1/4"	diameter

BRASS

		A	B
<b>7</b>	05.0B19.0302		3"
<b>8</b>	09.0E25.0122	1-1/4"	diameter
<b>9</b>	05.1300.2	1-1/2"	3-1/4"
<b>10</b>	05.1310.2	1-5/32"	2-1/4"
<b>11</b>	05.1320.2	2-1/4"	2-1/4"

# ENGLISH BRASS COLLECTION

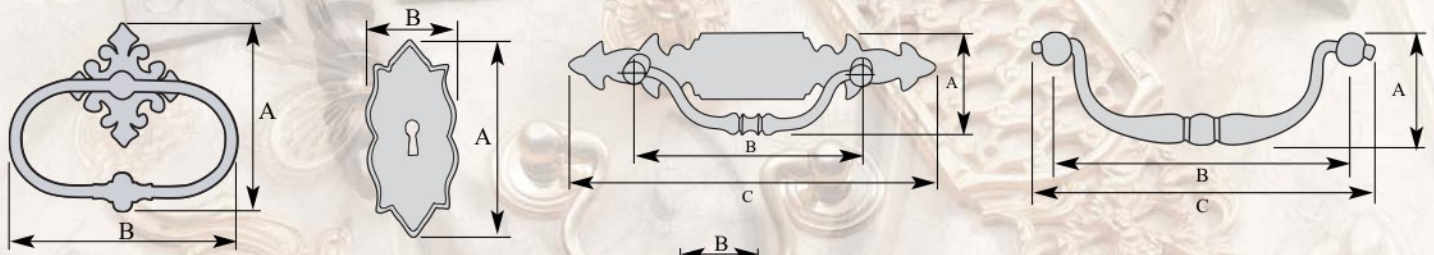
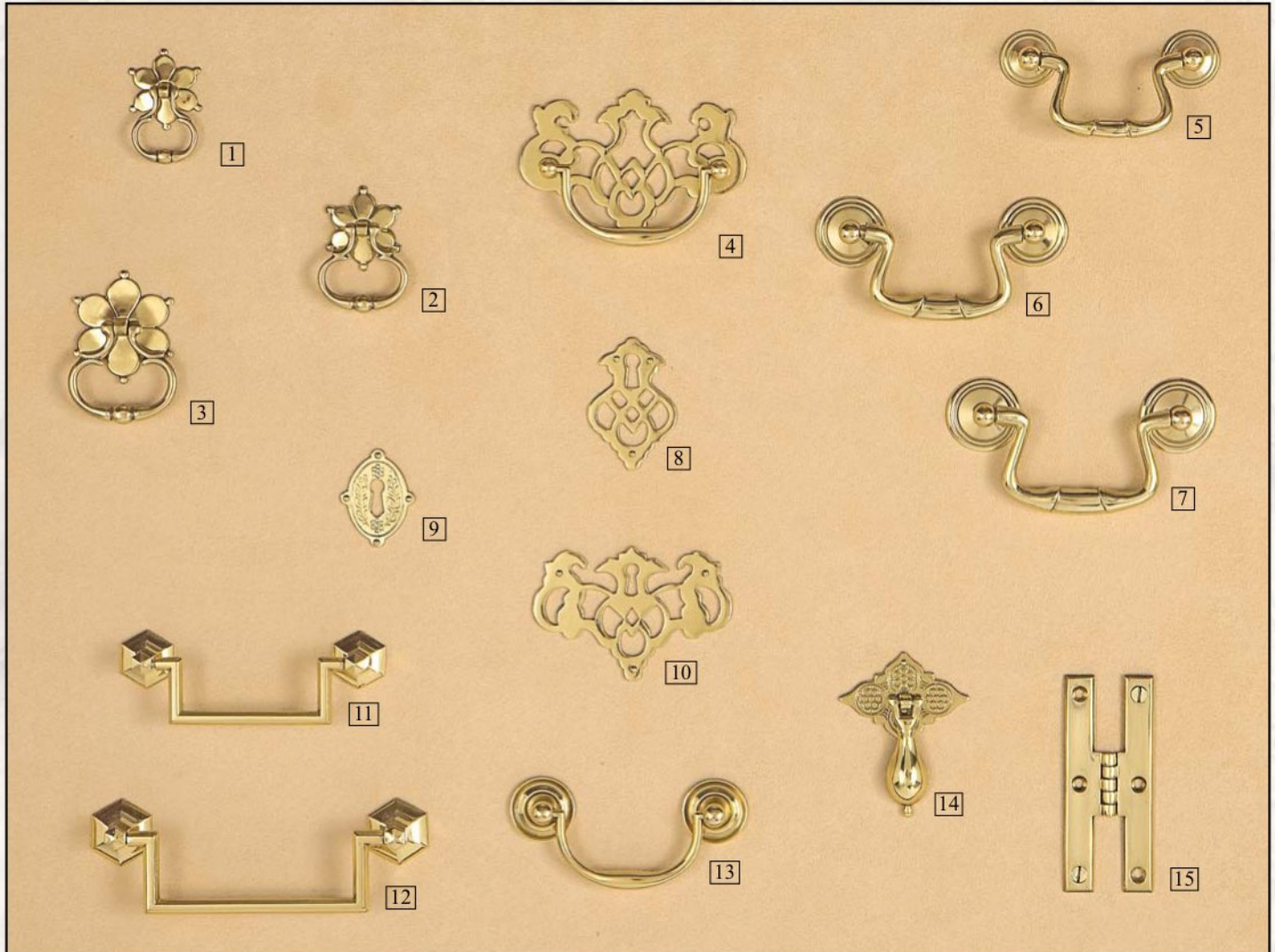

BRASS		A	B	C
<b>1</b>	05.1701.0322	2-1/8"	1-5/16"	
<b>2</b>	05.1701.0382	2-3/8"	1-5/8"	
<b>3</b>	05.1701.0502	2-3/4"	2-7/8"	
<b>4</b>	05.1512.4002	2-7/8"	3"	4"
<b>5</b>	05.0408.0252	2"	3"	3-7/8"
<b>6</b>	05.0408.0302	2-1/4"	3-1/4"	4-1/2"
<b>7</b>	05.0408.0352	2-1/2"	3-1/2"	4-7/8"
<b>8</b>	09.1597.0602	2-1/2"	1-5/8"	

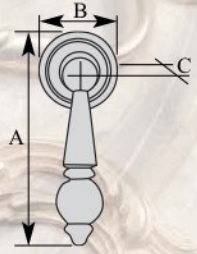

BRASS		A	B	C
<b>9</b>	09.1599.0442	1-7/8"	1-3/8"	
<b>10</b>	09.1559.0352	2-1/2"	3-9/16"	
<b>11</b>	05.0439.0852	1-3/4"	3-3/4"	4-3/4"
<b>12</b>	05.0439.1202	2-1/8"	5"	6-1/8"
<b>13</b>	05.1512.2	2"	3-1/8"	4-3/8"
<b>14</b>	07.1892.0572	3-1/8"	2-3/8"	
<b>15</b>	01.2527.0712	4"	1-5/8"	



# LOUIS XIV BRASS COLLECTION

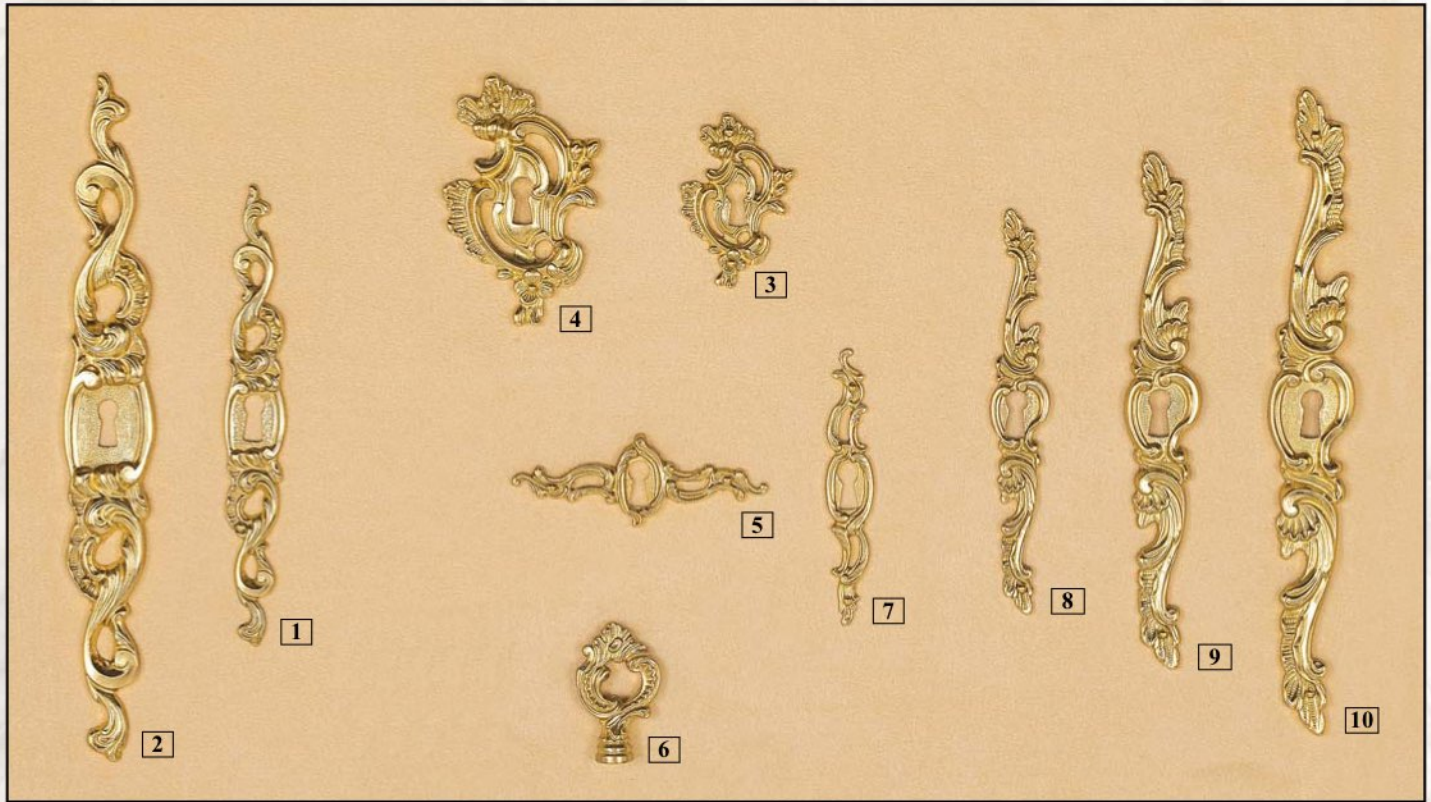

BRASS		A	B
<b>1</b>	08.0320.0152	5-7/8"	3/4"
<b>2</b>	08.0320.0222	8-3/4"	1-1/8"
<b>3</b>	09.0455.0552	2-3/16"	1-7/16"
<b>4</b>	09.0455.0802	3-1/4"	2"
<b>5</b>	08.331.79	1-1/4"	3-1/2"
<b>6</b>	14.0043.0002	1-3/4"	1-1/8"
<b>7</b>	08.0331.0902	3-1/2"	1-1/4"
<b>8</b>	08.0310.0132	5-1/8"	3/4"
<b>9</b>	08.0310.0172	6-3/4"	1"
<b>10</b>	08.0310.0222	8-1/4"	1-1/8"

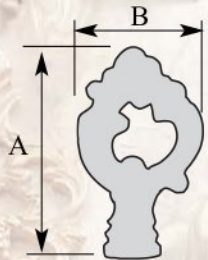
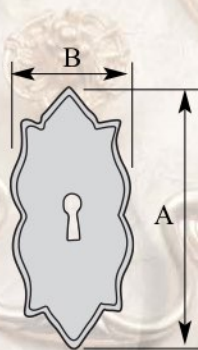

# LOUIS XV BRASS COLLECTION

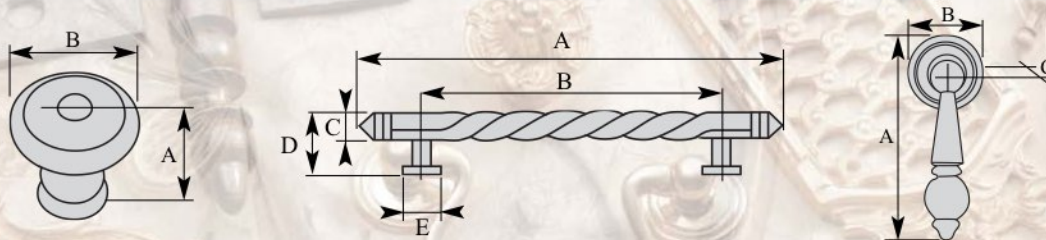
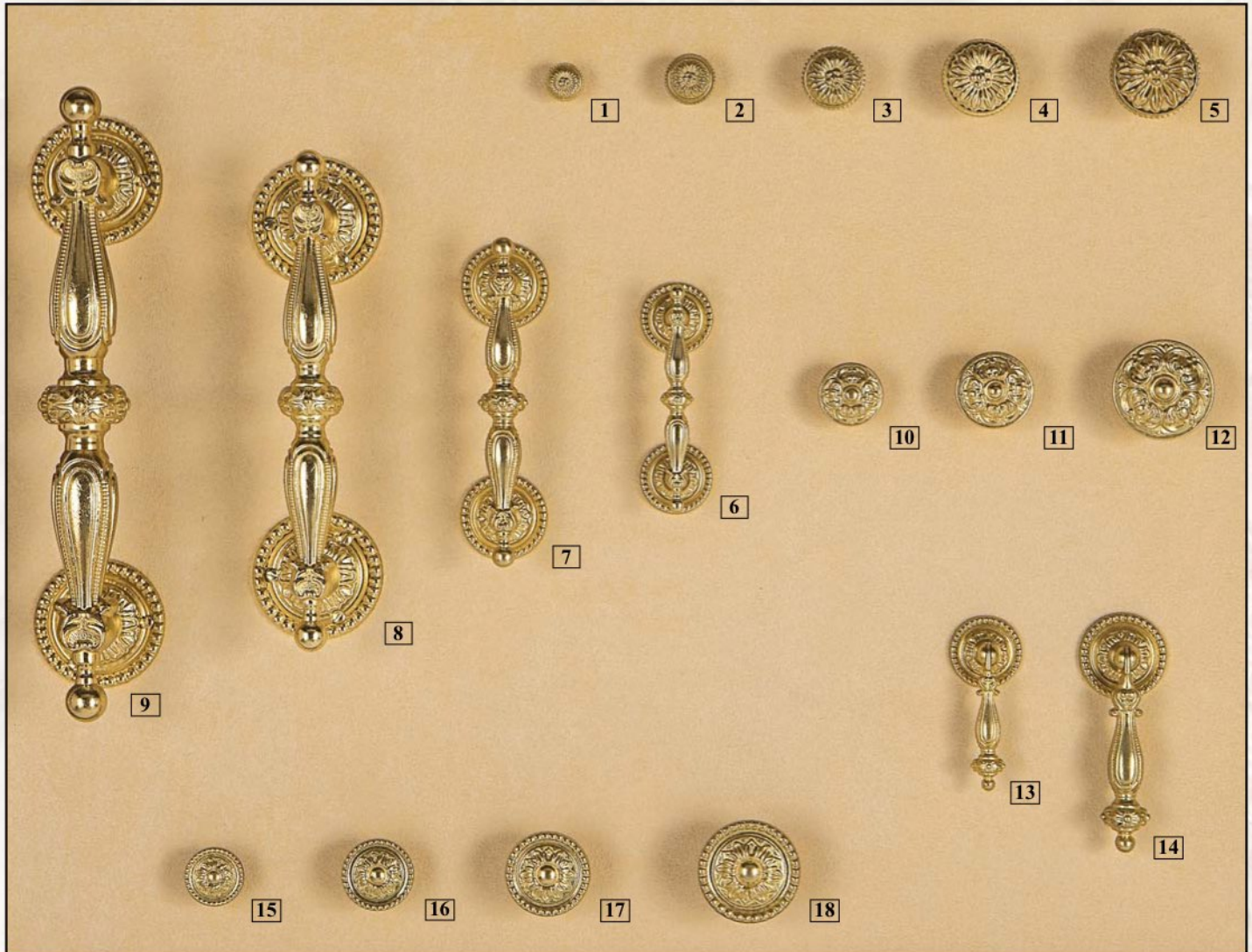

BRASS		A	B	C	D	E
<b>1</b>	06.1288.0152	9/16"	5/8"			
<b>2</b>	06.1288.0202	11/16"	11/16"			
<b>3</b>	06.1288.0252	7/8"	1"			
<b>4</b>	06.1288.0302	1"	1-3/16"			
<b>5</b>	06.1288.0352	1-3/16"	1-3/8"			
<b>6</b>	05.0423.0902*	3-1/2"	2-1/2"	1/2"	1-1/4"	1-1/8"
<b>7</b>	05.0423.1302*	5"	3-5/8"	3/4"	1-1/2"	1-5/16"
<b>8</b>	19.0423.0192*	7-5/8"	5-1/2"	1-1/8"	2-1/8"	2"
<b>9</b>	19.0423.0242*	9-5/8"	6-7/8"	1-3/8"	2-1/2"	2"

BRASS		A	B	C
<b>10</b>	06.0132.0252	3/4"	1"	
<b>11</b>	06.0132.0302	7/8"	1-3/16"	
<b>12</b>	06.0132.0402	1-1/8"	1-1/2"	
<b>13</b>	07.0424.0502	2-5/8"	1-1/8"	7/8"
<b>14</b>	07.0424.0702	3-3/4"	1-5/16"	1"
<b>15</b>	06.0150.0202	5/8"	3/4"	
<b>16</b>	06.0150.0282	3/4"	1-1/8"	
<b>17</b>	06.0150.0332	15/16"	1-5/16"	
<b>18</b>	06.0150.0402	1-1/8"	1-9/16"	

\* See Building section for larger size.



# LOUIS XIV AND XV BRASS COLLECTIONS

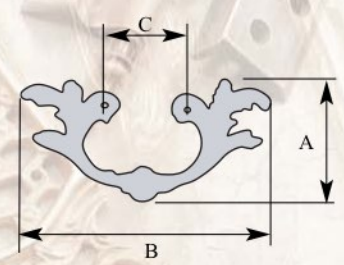
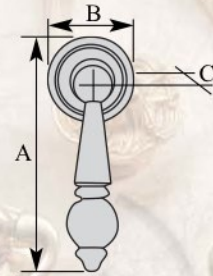
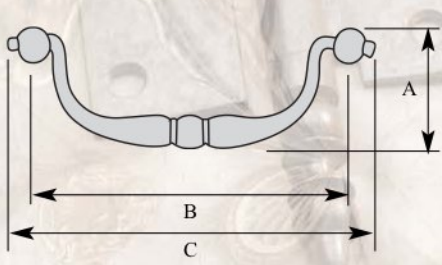
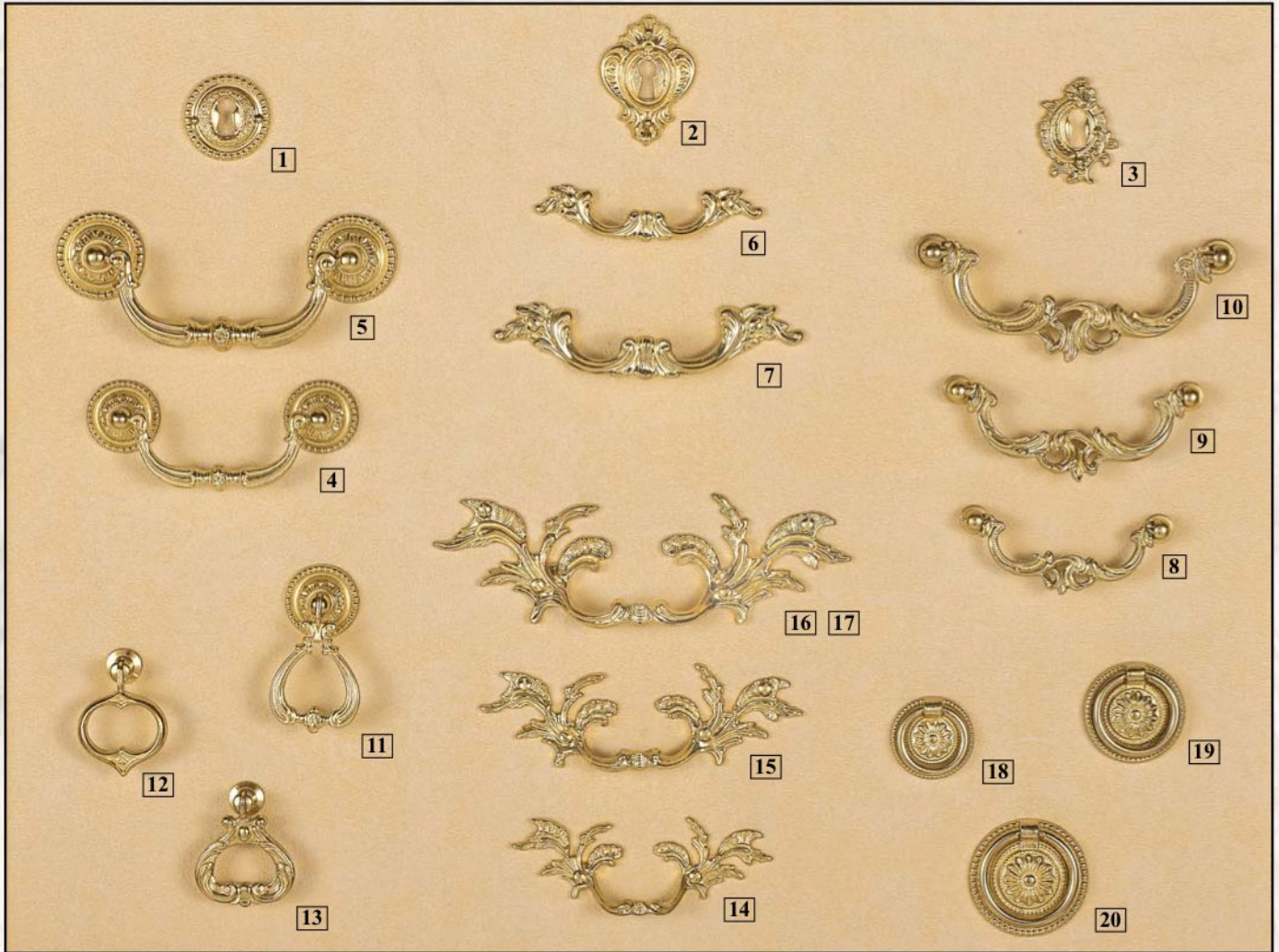

BRASS	A	B	C
<b>1</b> 09.421.2		1-3/8"	diameter
<b>2</b> 09.2081.2	2"	1-1/2"	
<b>3</b> 09.4360.0402	1-5/8"	1-1/4"	
<b>4</b> 05.0420.752	1-5/8"	3"	4-1/8"
<b>5</b> 05.0420.952	2"	3-7/8"	5-1/4"
<b>6</b> 05.0470.92	7/8"	3-1/2"	
<b>7</b> 05.0470.122	1-1/8"	4-3/4"	
<b>8</b> 05.4530.0702	1-1/4"	2-13/16"	3-3/16"
<b>9</b> 05.4530.0902	1-1/2"	3-7/16"	3-7/8"
<b>10</b> 05.4530.1102	1-3/4"	4-1/4"	4-1/2"

BRASS	A	B	C
<b>11</b> 07.53.2	2-1/2"	1-3/8"	5/8"
<b>12</b> 07.51.2	1-7/8"	1-3/8"	5/8"
<b>13</b> 07.70.2	1-3/4"	1-1/2"	5/8"
<b>14</b> 05.2076.1002	1-7/16"	3-15/16"	
<b>15</b> 05.2076.1202	1-1/2"	4-7/8"	
<b>16</b> 05.2076.1552	2"	6-1/4"	
<b>17</b> 05.2076.2102	2-3/4"	8-1/2"	not shown
<b>18</b> 05.37.332		1-1/4"	diameter
<b>19</b> 05.37.392		1-9/16"	diameter
<b>20</b> 05.37.462		1-13/16"	diameter

# FROM OUR "KINGS OF FRANCE" FURNITURE COLLECTIONS



Above catalog is available for a fee

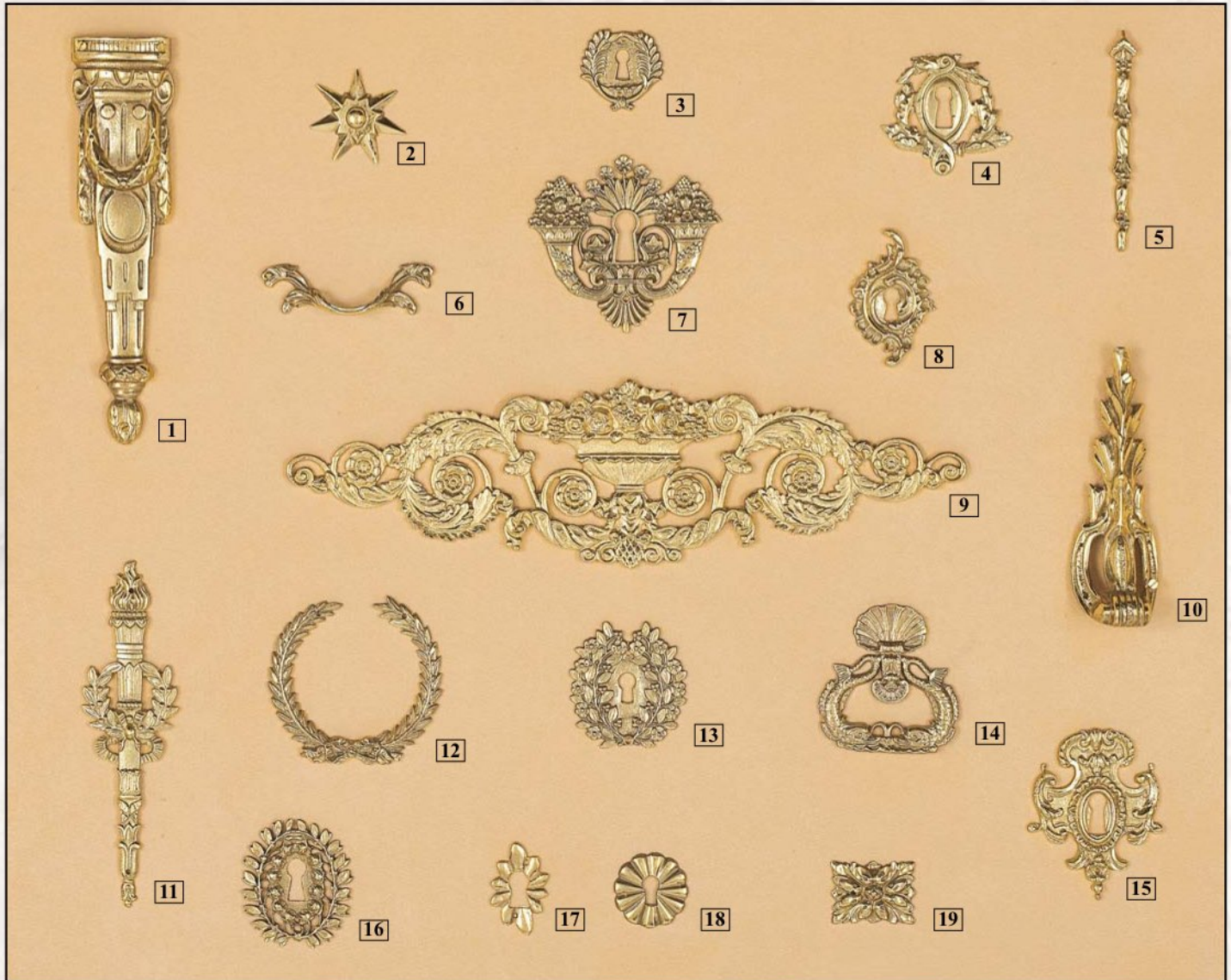

BRASS	A	B
<b>1</b> 25.0257.0192	7-3/4"	2"
<b>2</b> 25.2268.0002	1-3/4"	diameter
<b>3</b> 09.595	1-9/16"	1-9/16"
<b>4</b> 09.228	2-1/4"	2-7/16"
<b>5</b> 25.0664.1052	4-1/8"	1/2"
<b>6</b> 05.0628.0722	1"	3-1/8"
<b>7</b> 09.708	3-3/8"	3-5/8"
<b>8</b> 09.1563.0652	2-5/8"	1-5/8"
<b>9</b> 25.2057.3202	3-5/8"	12-1/2"
<b>10</b> 25.0617.1452	5-1/4"	1-3/4"

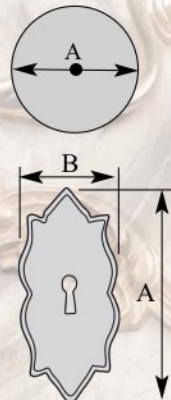

BRASS	A	B
<b>11</b> 25.0241.1652	6-1/2"	1-3/4"
<b>12</b> 25.0674.0802	3-1/4"	3-1/4"
<b>13</b> 09.336	2-7/16"	2-1/4"
<b>14</b> 05.0710.0782	2-3/4"	2-5/8"
<b>15</b> 09.0823.0822	3-1/2"	2-1/2"
<b>16</b> 09.890	2-7/16"	2"
<b>17</b> 09.0668.0272	1-3/4"	1-1/8"
<b>18</b> 09.0337.0352	1-3/8"	diameter
<b>19</b> 25.0158.0402	1-1/4"	1-5/8"



# ART NOUVEAU AND ART DECO BRASS COLLECTIONS

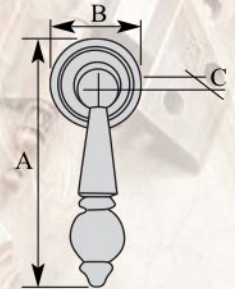
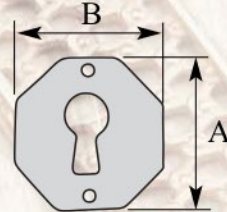
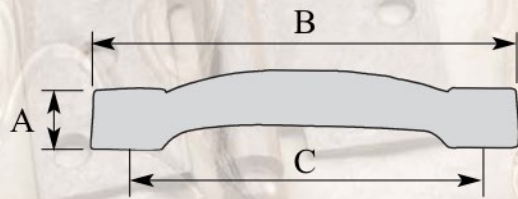

BRASS		A	B	C
<b>1</b>	08.1991.2	3-1/8"	7/8"	
<b>2</b>	09.1991.2	7/8"	3-1/8"	
<b>3</b>	05.1994.2L/R	8"	1-1/2"	3/4"
<b>4</b>	05.1993.2L/R	3-7/8"	1-1/4"	
<b>5</b>	05.1969.102	5/8"	4-3/8"	
<b>6</b>	05.1969.142	3/4"	6-1/8"	
<b>7</b>	07.1977.2	2-1/2"	5/8"	

# ART DECO BRASS COLLECTION

*E.H.F.*

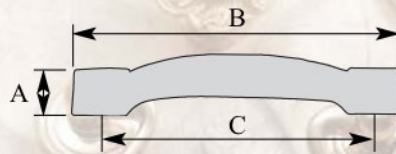
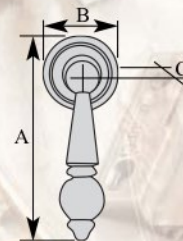
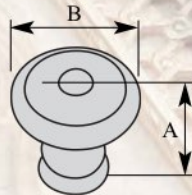
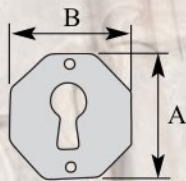
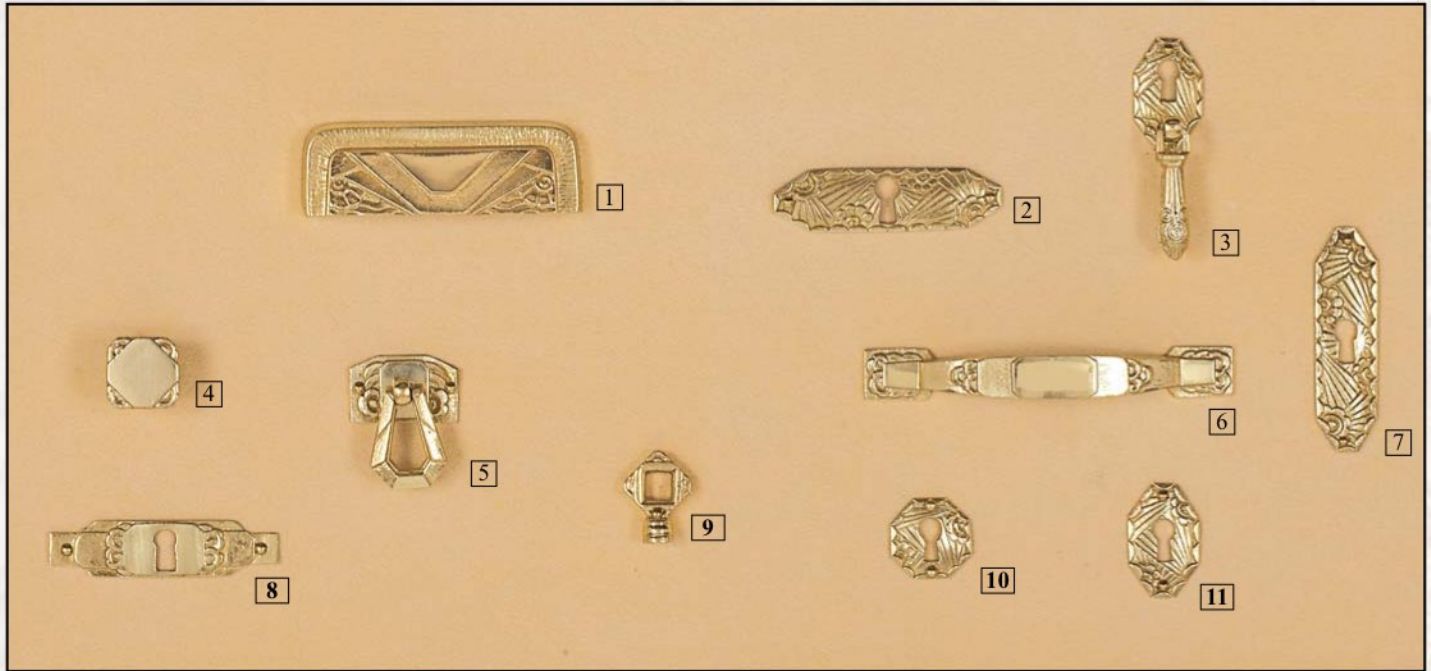

BRASS		A	B	C
<b>1</b>	05.1283.0952	1-3/8"	3-3/4"	
<b>2</b>	09.1274.0002	7/8"	3"	
<b>3</b>	07.1271.0002	2-7/8"	15/16"	
<b>4</b>	06.1225.0002	1"	1"	
<b>5</b>	07.1211.0002	1-3/4"	1-1/2"	
<b>6</b>	05.1201.1252	5/8"	4-7/8"	3-3/16"

BRASS		A	B	C
<b>7</b>	09.1273.0002	3"	7/8"	
<b>8</b>	09.1218.0002	3/4"	3"	
<b>9</b>	14.0595.0402	1"	7/8"	
<b>10</b>	09.1276.0002	1-1/8"	1-1/8"	
<b>11</b>	09.1275.0002	1-1/2"	1"	



*European Hardware and Finishes*  
*Gerber Hinge Co.*

16554 Arminta St.  
Van Nuys, CA 91406

800.643.7237 | [info@gerberhinge.com](mailto:info@gerberhinge.com)